



LAVALLEE & IDE

America's Premier Reamer Manufacturer



Since 1937



FEATURING THE GREATEST
SELECTION OF REAMERS

WITH OVER

30,000

SIZES & STYLES OFFERED IN
HIGH SPEED, COBALT, & CARBIDE



LAVALLEE & IDE

L&I has been manufacturing precision ground reamers
in the U.S.A. for over 78 years.

**Offering the largest selection of in-stock
reamer styles and sizes.**



L&I manufacturing facility. Michigan - USA

Featured in this catalog:













- Hundreds of new added sizes.
- The biggest offering of Intermediate Decimal Size Reamers in the world.
- 91 reamer sets in the choices of metal cases, wood cases, and plastic pouches.
- Silver & Deming reamers; exclusive stock item.
- Stub Screw Machine Reamers sizes by .0001", from 0.0961" to 1.0100".
- Production Length Reamers.
- Extra Long Chucking Reamers in 6", 8", and 12" overall lengths.
- Solid Carbide & Carbide Tipped Reamers.
- Aligning, Aligning Hex Shank, Construction, Bridge, and Car Reamers.
- Taper Pin Reamers available in Straight, Spiral, or Helical Flute.

Find the correct reamer for every job application.





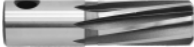
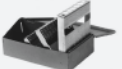







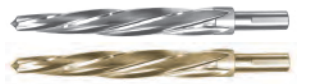

Alterations per print available, see quote form on page 59-61.

Index









LAVALLEE & IDE®

Description	List #	Page	Pictorial
Chucking Reamers & Sets H.S. Straight Flute H.S. Right Hand Spiral, Right Hand Cut H.S. Left Hand Spiral, Right Hand Cut Cobalt, Straight Flute Cobalt, Right Hand Spiral, Right Hand Cut	LV533 LV535 LV535L 1533 1535	4-10	
Decimal Chucking Reamers H.S. Straight Flute H.S. Right Hand Spiral, Right Hand Cut H.S. Left Hand Spiral, Right Hand Cut Cobalt, Straight Flute Cobalt, Right Hand Spiral, Right Hand Cut	LV533 LV535 LV535L 1533 1535	11-28	
Dowel Pin Reamers & Sets H.S. Straight Flute H.S. Right Hand Spiral, Right Hand Cut Cobalt, Straight Flute Cobalt, Right Hand Spiral, Right Hand Cut	LV570DP LV575DP 1570DP 1575DP	29	
Dowel Pin Reamers & Sets Production/CNC/Jobber Drill Length H.S. Straight Flute H.S. Right Hand Spiral, Right Hand Cut	DL570DP DL575DP	29	
Chucking Reamers & Sets Production/CNC/Jobber Drill Length H.S. Straight Flute H.S. Right Hand Spiral, Right Hand Cut	DL533 DL535	30-32	
Extra Long Chucking Reamers H.S. Straight Flute	LV533XL	33	
Silver & Deming Reamers & Sets H.S. Straight Flute	LV5303	33	
Solid Carbide Chucking Reamers Straight Shank, Straight Flute	C805	34-40	
Carbide Tipped Chucking Reamers Straight Shank, Straight Flute Straight Shank, Spiral Flute, Right Hand Cut	CT550 CT551	40	
Combination Drill & Reamer - DROLER® H.S. Jobber Length	LV524	41	
CNC Stub Screw Machine Reamers H.S. Left Hand Spiral, Right Hand Cut	554U	41	
HUOT® Reamer Index		41	
Hand Reamers H.S. Straight Flute H.S. Left Hand Spiral, Right Hand Cut	564U 565U	42-43	
Metric Hand Reamers H.S. Straight Flute	564MU	44	

Index

Description	List #	Page	Pictorial
Adjustable Hand Reamers & Sets High Speed Steel	570U	44	
Expansion Hand Reamers & Sets H.S. Straight Flute H.S. Left Hand Spiral, Right Hand Cut	576U 577U	45	
Expansion Chucking Reamers H.S. Straight Shank, Straight Flute H.S. Taper Shank, Straight Flute	572U 574U	46	
Morse Taper Roughing and Finishing Reamers & Sets H.S. Straight Shank - Finishing Reamers H.S. Taper Shank - Finishing Reamers H.S. Straight Shank - Roughing Reamers H.S. Taper Shank - Roughing Reamers	568U 569U 552U 559U	47	
Brown & Sharpe Taper Reamers & Sets H.S. Straight Shank, Straight Flute - Finishing Reamers	596U	47	
Jarno Taper Reamers H.S. Straight Shank, Straight Flute - Finishing Reamers	599U	47	
Aligning Reamers & Sets H.S. Left Hand Spiral Flute, Right Hand Cut Cobalt Left Hand Spiral Flute	535R 535RC	48	
Hex Nut Shank Style Aligning Reamers H.S. Left Hand Spiral Flute, Right Hand Cut	535H	48	
Construction Aligning Reamers & Sets H.S. Left Hand Spiral Flute, Right Hand Cut with stop collar	583CR	48	
Bridge Reamers H.S. Left Hand Spiral Flute, Right Hand Cut H.S. Straight Flute	532 533	49	
Car Reamers - Short Body H.S. Left Hand Spiral Flute, Right Hand Cut H.S. Straight Flute	535 534	49	
Taper Shank Chucking Reamers H.S. Straight Flute H.S. Right Hand Spiral, Right Hand Cut H.S. Left Hand Spiral, Right Hand Cut	530U 531U 537LU	50-51	
Taper Shank Jobber Reamers H.S. Straight Flute	578U	51	
Taper Pin Reamers & Sets H.S. Straight Flute H.S. Left Hand Spiral, Right Hand Cut H.S. Left Hand Helical Flute	556U 557U 558U	52	
Metric Taper Pin Reamers H.S. Straight Flute Left Hand Spiral, Right Hand Cut	556MU 557MU	52	

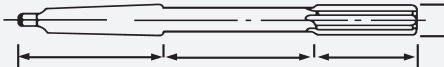
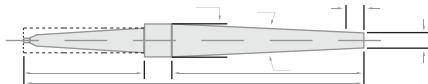
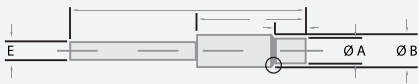
Index

Description	List #	Page	Pictorial
Taper Pipe Reamers H.S. Straight Flute H.S. Left Hand Spiral Flute	566U 567U	53	
Taper Pipe Taps H.S. Taper (NPT) H.S. Interrupted Thread Taper (INT/NPT) Carbon Steel Taper (NPT)	790U 792U 793U	53	
Shell Reamers H.S. Straight Flute H.S. Left Hand Spiral, Right Hand Cut	560U 561U	54	
Carbide Tipped Shell Reamers Straight Flute	CT560	55	
Shell Reamer Arbors Straight Shanks Taper Shanks		55	
E-Z Eject Shell Reamer Arbors Straight Shanks Taper Shanks		55	
Drill & Reamer Blanks & Sets M-2 High Speed Steel		56-58	
Special Reamer Request Form		59	
Special Taper Reamer Request Form		60	
Special Step Reamer Request Form		61	
Reamer Sets		62-63	
Reaming Recommendations		64	
Decimal Equivalents and Tap Sizes of Fraction, Number, Letter and Metric Sizes		Inside Back Cover	

Chucking Reamers - Straight Shank High Speed Steel & Cobalt



- List No. **LV533**: High Speed, Straight Flute
- List No. **LV535**: High Speed, Right Hand Spiral, Right Hand Cut
- List No. **LV535L**: High Speed, Left Hand Spiral, Right Hand Cut
- List No. **1533**: Cobalt, Straight Flute
- List No. **1535**: Cobalt, Right Hand Spiral, Right Hand Cut

These high-quality tools are designed for most standard reaming needs.

Specifications					Price Each				
Diameter	Decimal Equivalent	Flute Length	Overall Length	Shank Diameter	LV533 Straight Flute	LV535 RH Spiral	LV535L LH Spiral RH Cut	1533 Cobalt Str. Flt.	1535 Cobalt RH Spiral
# 80	.0135	3/8	3/4	.0135	17.90	22.00	—	23.00	—
# 79	.0145	3/8	3/4	.0145	17.90	22.00	—	23.00	—
1/64	.0156	3/8	3/4	.0156	17.90	—	—	23.00	—
# 78	.0160	3/8	7/8	.0160	17.90	22.00	—	23.00	—
# 77	.0180	3/8	7/8	.0180	17.90	22.00	—	23.00	—
# 76	.0200	3/8	7/8	.0200	17.90	22.00	—	23.00	—
# 75	.0210	1/2	1	.0210	17.90	—	—	23.00	—
# 74	.0225	1/2	1	.0225	17.90	22.00	—	23.00	—
# 73	.0240	1/2	1 1/8	.0240	17.90	22.00	—	23.00	—
# 72	.0250	1/2	1 1/8	.0250	17.90	22.00	—	23.00	—
# 71	.0260	1/2	1 1/4	.0260	17.90	—	—	23.00	—
# 70	.0280	1/2	1 1/4	.0280	17.90	22.00	—	23.00	—
# 69	.0292	1/2	1 3/8	.0292	17.90	—	—	23.00	—
# 68	.0310	1/2	1 3/8	.0310	17.90	—	—	23.00	—
1/32	.0312	1/2	1 3/8	.0312	14.95	—	—	23.00	—
# 67	.0320	1/2	1 3/8	.0320	15.25	—	—	23.00	—
# 66	.0330	1/2	1 3/8	.0330	15.25	—	—	23.00	—
# 65	.0350	1/2	1 1/2	.0350	15.25	—	—	23.00	—
# 64	.0360	1/2	1 1/2	.0360	15.25	22.00	—	23.00	—
# 63	.0370	1/2	1 1/2	.0370	15.25	16.90	—	23.00	—
# 62	.0380	1/2	1 1/2	.0380	15.25	—	—	23.00	—
# 61	.0390	1/2	1 5/8	.0390	15.25	—	—	23.00	—
1mm	.0394	1/2	2 1/2	.0394	15.25	17.50	—	23.00	—
# 60	.0400	1/2	2 1/2	.0390	15.25	17.50	19.50	21.00	22.00
# 59	.0410	1/2	2 1/2	.0390	15.25	17.50	19.50	21.00	22.00
# 58	.0420	1/2	2 1/2	.0390	15.25	17.50	19.50	21.00	22.00
# 57	.0430	1/2	2 1/2	.0390	15.25	17.50	19.50	21.00	22.00
# 56	.0465	1/2	2 1/2	.0455	15.25	17.50	19.50	21.00	22.00
3/64	.0469	1/2	2 1/2	.0455	15.25	17.50	19.50	21.00	22.00
# 55	.0520	1/2	2 1/2	.0510	15.25	17.50	19.50	21.00	22.00
# 54	.0550	1/2	2 1/2	.0510	15.25	17.50	19.50	21.00	22.00
1.5mm	.0591	1/2	2 1/2	.0510	15.25	17.50	19.50	21.00	22.00
# 53	.0595	1/2	2 1/2	.0585	15.25	17.50	19.50	21.00	22.00
1/16	.0625	1/2	2 1/2	.0585	13.60	17.50	19.50	21.00	22.00
# 52	.0635	1/2	2 1/2	.0585	13.60	17.50	19.50	21.00	22.00
# 51	.0670	3/4	3	.0660	12.25	14.20	15.90	17.00	18.00
# 50	.0700	3/4	3	.0660	12.25	14.20	15.90	17.00	18.00
# 49	.0730	3/4	3	.0660	12.25	14.20	15.90	17.00	18.00
# 48	.0760	3/4	3	.0720	12.25	14.20	15.90	17.00	18.00
1.95mm	.0768	3/4	3	.0720	15.25	—	—	—	—
5/64	.0781	3/4	3	.0720	12.25	14.20	15.90	17.00	18.00
# 47	.0785	3/4	3	.0720	12.25	14.20	15.90	17.00	18.00
2mm	.0787	3/4	3	.0771	12.25	14.20	15.90	17.00	18.00
Over 2mm	.0791	3/4	3	.0720	18.70	—	—	—	—
# 46	.0810	3/4	3	.0771	12.25	14.20	15.90	17.00	18.00
# 45	.0820	3/4	3	.0771	12.25	14.20	15.90	17.00	18.00
2.10 mm	.0827	3/4	3	.0810	18.70	—	—	—	—
# 44	.0860	3/4	3	.0810	12.25	14.20	15.90	17.00	18.00
# 43	.0890	3/4	3	.0810	12.25	14.20	15.90	17.00	18.00
# 42	.0935	3/4	3	.0880	12.25	14.20	15.90	17.00	18.00
3/32	.0938	3/4	3	.0880	10.97	14.20	15.90	17.00	18.00
# 41	.0960	7/8	3 1/2	.0928	12.55	14.20	15.90	17.00	18.00
# 40	.0980	7/8	3 1/2	.0928	12.55	14.20	15.90	17.00	18.00
2.5mm	.0984	7/8	3 1/2	.0928	12.55	14.20	15.90	17.00	18.00
# 39	.0995	7/8	3 1/2	.0928	12.55	14.20	15.90	17.00	18.00
# 38	.1015	7/8	3 1/2	.0950	12.55	14.20	15.90	17.00	18.00

Diameter Tolerance: Through 1/2" $-.0000" \text{ } -.000\text{m/m}$
 $+.0002" \text{ } +.005\text{m/m}$

Chucking Reamers - Straight Shank High Speed Steel & Cobalt



- List No. **LV533**: High Speed, Straight Flute
- List No. **LV535**: High Speed, Right Hand Spiral, Right Hand Cut
- List No. **LV535L**: High Speed, Left Hand Spiral, Right Hand Cut
- List No. **1533**: Cobalt, Straight Flute
- List No. **1535**: Cobalt, Right Hand Spiral, Right Hand Cut

These high-quality tools are designed for most standard reaming needs.

Specifications					Price Each				
Diameter	Decimal Equivalent	Flute Length	Overall Length	Shank Diameter	LV533 Straight Flute	LV535 RH Spiral	LV535L LH Spiral RH Cut	1533 Cobalt Str. Flt.	1535 Cobalt RH Spiral
# 37	.1040	7/8	3 1/2	.0950	12.55	14.20	15.90	17.00	18.00
2.70mm	.1063	7/8	3 1/2	.1030	14.95	—	—	—	—
# 36	.1065	7/8	3 1/2	.1030	12.55	14.20	15.90	17.00	18.00
2.75 mm	.1083	7/8	3 1/2	.1030	14.95	—	—	—	—
7/64	.1094	7/8	3 1/2	.1030	12.90	14.80	16.20	18.00	19.00
# 35	.1100	7/8	3 1/2	.1030	12.90	14.80	16.20	18.00	19.00
# 34	.1110	7/8	3 1/2	.1030	12.90	14.80	16.20	18.00	19.00
# 33	.1130	7/8	3 1/2	.1055	12.90	14.80	16.20	18.00	19.00
# 32	.1160	7/8	3 1/2	.1120	12.90	14.80	16.20	18.00	19.00
Under 3mm	.1171	7/8	3 1/2	.1120	15.95	—	—	—	—
3mm	.1181	7/8	3 1/2	.1120	12.90	14.80	16.20	18.00	19.00
Over 3mm	.1191	7/8	3 1/2	.1120	15.95	—	—	—	—
# 31	.1200	7/8	3 1/2	.1120	12.90	14.80	16.20	18.00	19.00
Under 1/8	.1240	7/8	3 1/2	.1190	12.90	14.80	16.20	18.00	19.00
1/8	.1250	7/8	3 1/2	.1190	12.90	13.20	15.00	15.50	16.60
Over 1/8	.1260	7/8	3 1/2	.1190	12.90	14.80	16.20	18.00	19.00
# 30	.1285	7/8	3 1/2	.1190	12.90	14.80	16.20	18.00	19.00
3.4mm	.1339	1	4	.1275	12.90	14.80	—	—	29.75
# 29	.1360	1	4	.1275	15.25	17.50	20.00	21.00	22.20
3.5mm	.1378	1	4	.1350	15.25	17.50	20.00	21.00	22.20
Under 9/64	.1396	1	4	.1350	18.90	—	—	—	—
# 28	.1405	1	4	.1350	15.25	17.50	20.00	21.00	22.20
9/64	.1406	1	4	.1350	15.25	17.50	20.00	21.00	22.20
Over 9/64	.1416	1	4	.1350	18.90	—	—	—	—
3.6mm	.1417	1	4	.1350	15.25	24.80	—	28.00	—
# 27	.1440	1	4	.1350	15.25	17.50	20.00	21.00	22.20
# 26	.1470	1	4	.1430	15.25	17.50	20.00	21.00	22.20
# 25	.1495	1	4	.1430	15.25	17.50	20.00	21.00	22.20
# 24	.1520	1	4	.1460	15.25	17.50	20.00	21.00	22.20
# 23	.1540	1	4	.1460	15.25	17.50	20.00	21.00	22.20
Under 5/32	.1552	1	4	.1510	18.90	—	—	—	—
5/32	.1562	1	4	.1510	15.25	17.50	20.00	21.00	22.20
# 22	.1570	1	4	.1510	15.25	17.50	20.00	21.00	22.20
Over 5/32	.1572	1	4	.1510	18.90	—	—	28.00	—
4mm	.1575	1 1/8	4 1/2	.1530	15.25	17.50	20.00	21.00	22.20
# 21	.1590	1 1/8	4 1/2	.1530	16.30	18.80	21.50	22.00	23.50
# 20	.1610	1 1/8	4 1/2	.1530	16.30	18.80	21.50	22.00	23.50
4.1mm	.1614	1 1/8	4 1/2	.1530	16.30	26.00	—	—	—
# 19	.1660	1 1/8	4 1/2	.1595	16.30	18.80	21.50	22.00	23.50
# 18	.1695	1 1/8	4 1/2	.1595	16.30	18.80	21.50	22.00	23.50
11/64	.1719	1 1/8	4 1/2	.1645	16.30	18.80	21.50	22.00	23.50
# 17	.1730	1 1/8	4 1/2	.1645	16.30	18.80	21.50	22.00	23.50
# 16	.1770	1 1/8	4 1/2	.1704	16.30	18.80	21.50	22.00	23.50
4.5mm	.1772	1 1/8	4 1/2	.1755	16.30	18.80	21.50	22.00	23.50
# 15	.1800	1 1/8	4 1/2	.1755	16.30	18.80	21.50	22.00	23.50
4.6mm	.1811	1 1/8	4 1/2	.1755	18.90	—	—	—	—
# 14	.1820	1 1/8	4 1/2	.1755	16.30	18.80	21.50	22.00	23.50
# 13	.1850	1 1/8	4 1/2	.1805	16.30	18.80	21.50	22.00	23.50
Under 3/16	.1865	1 1/8	4 1/2	.1805	16.30	18.80	21.50	22.00	23.50
3/16	.1875	1 1/8	4 1/2	.1805	16.30	18.80	21.50	22.00	23.50
Over 3/16	.1885	1 1/8	4 1/2	.1805	16.30	18.80	21.50	22.00	23.50
# 12	.1890	1 1/8	4 1/2	.1805	16.30	18.80	21.50	22.00	23.50
# 11	.1910	1 1/4	5	.1860	18.40	21.00	24.00	25.50	26.50
# 10	.1935	1 1/4	5	.1860	18.40	21.00	24.00	25.50	26.50
# 9	.1960	1 1/4	5	.1895	18.40	21.00	24.00	25.50	26.50
5 mm	.1969	1 1/4	5	.1895	18.40	21.00	24.00	25.50	26.50

Chuckling Reamers

Diameter Tolerance: Through 1/2" $-.0000" \text{ } -.000\text{m/m}$
 $+.0002" \text{ } +.005\text{m/m}$

Chucking Reamers - Straight Shank High Speed Steel & Cobalt



- List No. **LV533**: High Speed, Straight Flute
- List No. **LV535**: High Speed, Right Hand Spiral, Right Hand Cut
- List No. **LV535L**: High Speed, Left Hand Spiral, Right Hand Cut
- List No. **1533**: Cobalt, Straight Flute
- List No. **1535**: Cobalt, Right Hand Spiral, Right Hand Cut

These high-quality tools are designed for most standard reaming needs.

Specifications					Price Each				
Diameter	Decimal Equivalent	Flute Length	Overall Length	Shank Diameter	LV533 Straight Flute	LV535 RH Spiral	LV535L LH Spiral RH Cut	1533 Cobalt Str. Flt.	1535 Cobalt RH Spiral
# 8	.1990	1 1/4	5	.1895	18.40	21.00	24.00	25.50	26.50
5.1mm	.2008	1 1/4	5	.1945	22.00	27.40	—	—	—
# 7	.2010	1 1/4	5	.1945	18.40	21.00	24.00	25.50	26.50
13/64	.2031	1 1/4	5	.1945	18.40	21.00	24.00	25.50	26.50
# 6	.2040	1 1/4	5	.1945	18.40	21.00	24.00	25.50	26.50
# 5	.2055	1 1/4	5	.2016	18.40	21.00	24.00	25.50	26.50
# 4	.2090	1 1/4	5	.2016	18.40	21.00	24.00	25.50	26.50
# 3	.2130	1 1/4	5	.2075	18.40	21.00	24.00	25.50	26.50
5.5mm	.2165	1 1/4	5	.2075	18.40	21.00	24.00	25.50	26.50
Under 7/32	.2178	1 1/4	5	.2075	22.00	—	—	—	—
7/32	.2188	1 1/4	5	.2075	18.40	21.00	24.00	25.50	26.50
Over 7/32	.2198	1 1/4	5	.2075	22.00	—	—	—	—
# 2	.2210	1 1/2	6	.2173	18.90	21.70	24.80	26.00	27.40
# 1	.2280	1 1/2	6	.2173	18.90	21.70	24.80	26.00	27.40
A	.2340	1 1/2	6	.2265	18.90	21.70	24.80	26.00	27.40
15/64	.2344	1 1/2	6	.2265	18.90	21.70	24.80	26.00	27.40
6mm	.2362	1 1/2	6	.2265	19.80	21.70	24.80	26.00	27.40
B	.2380	1 1/2	6	.2329	19.80	21.70	24.80	26.00	27.40
6.1mm	.2402	1 1/2	6	.2329	23.00	—	—	—	—
C	.2420	1 1/2	6	.2329	19.80	21.70	24.80	26.00	27.40
6.2mm	.2441	1 1/2	6	.2329	23.00	—	—	—	—
D	.2460	1 1/2	6	.2329	19.80	21.70	24.80	26.00	27.40
Under 1/4	.2490	1 1/2	6	.2405	17.70	21.70	26.00	26.00	27.40
E 1/4	.2500	1 1/2	6	.2405	16.25	21.70	21.00	22.50	24.50
Over 1/4	.2510	1 1/2	6	.2405	17.70	21.70	26.00	22.50	27.40
6.5mm	.2559	1 1/2	6	.2485	19.80	21.70	26.00	28.00	29.00
F	.2570	1 1/2	6	.2485	19.80	21.70	26.00	28.00	29.00
6.6mm	.2598	1 1/2	6	.2485	23.00	—	—	—	—
G	.2610	1 1/2	6	.2485	19.80	21.70	26.00	28.00	29.00
17/64	.2656	1 1/2	6	.2485	21.95	24.40	27.00	34.00	35.67
H	.2660	1 1/2	6	.2485	21.95	24.40	27.00	34.00	35.67
I	.2720	1 1/2	6	.2485	21.95	24.40	27.00	34.00	35.67
7mm	.2756	1 1/2	6	.2485	21.95	24.40	27.00	34.00	35.67
J	.2770	1 1/2	6	.2485	21.95	24.40	27.00	34.00	35.67
K	.2810	1 1/2	6	.2485	21.95	24.40	27.00	34.00	35.67
9/32	.2812	1 1/2	6	.2485	21.95	24.40	27.00	34.00	35.67
7.3mm	.2874	1 1/2	6	.2792	26.00	—	—	—	—
L	.2900	1 1/2	6	.2792	22.20	24.40	27.00	34.00	35.67
7.4mm	.2913	1 1/2	6	.2792	26.00	—	—	—	—
M	.2950	1 1/2	6	.2792	22.20	24.40	27.00	34.00	35.67
7.5mm	.2953	1 1/2	6	.2792	22.20	24.40	27.00	34.00	35.67
19/64	.2969	1 1/2	6	.2792	22.20	24.40	27.00	34.00	35.67
N	.3020	1 1/2	6	.2792	22.20	24.40	27.00	34.00	35.67
7.8mm	.3071	1 1/2	6	.2792	26.00	—	—	—	—
Under 5/16	.3115	1 1/2	6	.2792	21.00	22.95	27.00	34.00	35.50
5/16	.3125	1 1/2	6	.2792	19.90	21.98	25.00	34.00	35.50
Over 5/16	.3135	1 1/2	6	.2792	21.00	22.95	27.00	34.00	35.50
8mm	.3150	1 1/2	6	.2792	22.20	24.45	28.00	34.00	35.50
O	.3160	1 1/2	6	.2792	22.20	24.45	28.00	34.00	35.50
P	.3230	1 1/2	6	.2792	23.75	26.00	29.40	37.00	38.62
Under 21/64	.3271	1 1/2	6	.2792	27.50	—	—	—	—
21/64	.3281	1 1/2	6	.2792	23.75	26.00	29.40	37.00	38.62
8.4mm	.3307	1 1/2	6	.2792	27.50	—	—	—	—
Q	.3320	1 1/2	6	.2792	23.75	26.00	29.40	37.00	38.62
8.5mm	.3346	1 1/2	6	.2792	23.75	26.00	29.40	37.00	38.62
R	.3390	1 1/2	6	.2792	23.75	26.00	29.40	37.00	38.62

Diameter Tolerance: Through 1/2" $-.0000" \text{ } -.000\text{m/m}$
 $+.0002" \text{ } +.005\text{m/m}$

Chucking Reamers - Straight Shank High Speed Steel & Cobalt



- List No. **LV533**: High Speed, Straight Flute
- List No. **LV535**: High Speed, Right Hand Spiral, Right Hand Cut
- List No. **LV535L**: High Speed, Left Hand Spiral, Right Hand Cut
- List No. **1533**: Cobalt, Straight Flute
- List No. **1535**: Cobalt, Right Hand Spiral, Right Hand Cut

These high-quality tools are designed for most standard reaming needs.

Specifications					Price Each				
Diameter	Decimal Equivalent	Flute Length	Overall Length	Shank Diameter	LV533 Straight Flute	LV535 RH Spiral	LV535L LH Spiral RH Cut	1533 Cobalt Str. Flt.	1535 Cobalt RH Spiral
21/32	.6562	2 1/4	9	.5620	44.00	48.00	51.90	77.00	80.00
17mm	.6693	2 1/4	9	.5620	46.50	61.00	65.00	88.00	—
43/64	.6719	2 1/4	9	.5620	46.50	61.00	—	—	—
Under 11/16	.6865	2 1/4	9	.5620	46.50	61.00	66.00	88.00	94.00
11/16	.6875	2 1/4	9	.5620	46.50	51.00	55.00	77.00	80.00
Over 11/16	.6885	2 1/4	9	.5620	49.55	61.00	66.00	88.00	94.00
17.5mm	.6890	2 1/4	9	.5620	49.55	64.00	—	—	—
45/64	.7031	2 1/4	9	.5620	49.55	64.00	—	93.00	—
18mm	.7087	2 1/4	9	.5620	49.55	64.00	71.00	93.00	—
23/32	.7188	2 1/4	9	.5620	49.55	57.00	61.50	91.00	94.00
18.5mm	.7283	2 1/4	9	.5620	57.50	71.00	—	—	—
47/64	.7344	2 1/4	9	.5620	57.50	68.00	75.00	90.00	101.00
19mm	.7480	2 1/2	9 1/2	.6245	57.50	72.50	—	90.00	—
Under 3/4	.7490	2 1/2	9 1/2	.6245	57.50	72.50	79.00	90.00	101.00
3/4	.7500	2 1/2	9 1/2	.6245	57.50	57.00	61.50	79.50	89.00
Over 3/4	.7510	2 1/2	9 1/2	.6245	57.50	72.50	79.00	90.00	101.00
49/64	.7656	2 1/2	9 1/2	.6245	57.50	72.50	81.75	99.00	—
19.5mm	.7677	2 1/2	9 1/2	.6245	57.50	72.50	—	—	—
25/32	.7812	2 1/2	9 1/2	.6245	57.50	62.00	67.70	84.50	96.00
20mm	.7874	2 1/2	9 1/2	.6245	59.90	76.50	81.75	—	—
51/64	.7969	2 1/2	9 1/2	.6245	59.90	76.50	81.75	102.00	115.00
20.5mm	.8071	2 1/2	9 1/2	.6245	59.90	76.50	—	—	—
Under 13/16	.8115	2 1/2	9 1/2	.6245	59.90	76.50	79.00	102.00	115.00
13/16	.8125	2 1/2	9 1/2	.6245	59.90	63.00	67.70	88.00	96.00
Over 13/16	.8135	2 1/2	9 1/2	.6245	59.90	76.50	79.00	102.00	115.00
21mm	.8268	2 1/2	9 1/2	.6245	59.90	78.85	—	—	—
53/64	.8281	2 1/2	9 1/2	.6245	59.90	78.85	86.00	—	—
27/32	.8438	2 1/2	9 1/2	.6245	69.00	74.00	79.00	102.00	114.00
21.5mm	.8465	2 1/2	9 1/2	.7495	69.00	90.00	97.00	—	—
55/64	.8594	2 1/2	9 1/2	.7495	69.00	90.00	97.00	125.00	—
22mm	.8661	2 1/2	9 1/2	.7495	69.00	90.00	—	—	—
Under 7/8	.8740	2 5/8	10	.7495	69.00	90.00	99.00	125.00	133.00
7/8	.8750	2 5/8	10	.7495	69.00	76.50	86.00	103.00	115.00
Over 7/8	.8760	2 5/8	10	.7495	69.00	90.00	99.00	125.00	133.00
22.5mm	.8858	2 5/8	10	.7495	71.00	91.50	—	—	—
57/64	.8906	2 5/8	10	.7495	71.00	91.50	99.00	140.00	—
23mm	.9055	2 5/8	10	.7495	71.00	91.50	—	—	—
29/32	.9062	2 5/8	10	.7495	76.50	84.00	89.40	112.00	125.00
59/64	.9219	2 5/8	10	.7495	76.50	99.00	110.00	140.00	—
23.5mm	.9252	2 5/8	10	.7495	76.50	99.00	—	—	—
Under 15/16	.9365	2 5/8	10	.7495	89.90	99.00	—	140.00	152.00
15/16	.9375	2 5/8	10	.7495	76.50	84.00	89.40	113.00	125.00
Over 15/16	.9385	2 5/8	10	.7495	89.90	99.00	102.00	140.00	152.00
24mm	.9449	2 5/8	10	.7495	76.50	99.00	110.00	—	—
61/64	.9531	2 5/8	10	.7495	76.50	99.00	110.00	149.00	—
24.5mm	.9646	2 5/8	10	.7495	76.50	99.00	—	—	—
31/32	.9688	2 5/8	10	.7495	81.00	92.00	99.00	128.00	140.00
25mm	.9843	2 3/4	10 1/2	.8745	81.00	104.40	—	—	—
63/64	.9844	2 3/4	10 1/2	.8745	81.00	104.40	119.00	148.00	160.00
Under 1	.9990	2 3/4	10 1/2	.8745	81.00	104.00	—	148.00	160.00
1	1.0000	2 3/4	10 1/2	.8745	81.00	92.00	99.00	128.00	143.00
Over 1	1.0010	2 3/4	10 1/2	.8745	85.75	104.40	110.00	148.00	160.00
25.5mm	1.0039	2 3/4	10 1/2	.8745	85.75	116.00	128.00	—	—
1 1/64	1.0156	2 3/4	10 1/2	.8745	128.00	—	—	—	—
1 1/32	1.0312	2 3/4	10 1/2	.8745	115.00	124.00	—	—	—
1 1/16	1.0625	2 3/4	10 1/2	.8745	90.00	103.75	110.00	139.00	—

Diameter Tolerance:	5/8" Through 1" +.0001" +.0025m/m +.0005" +.012m/m	1" Through 2" +.0002" +.005m/m +.0006" +.015m/m
----------------------------	---	--

Chucking Reamers

Chucking Reamers - Straight Shank High Speed Steel & Cobalt



- List No. **LV533**: High Speed, Straight Flute
- List No. **LV535**: High Speed, Right Hand Spiral, Right Hand Cut
- List No. **LV535L**: High Speed, Left Hand Spiral, Right Hand Cut
- List No. **1533**: Cobalt, Straight Flute
- List No. **1535**: Cobalt, Right Hand Spiral, Right Hand Cut

These high-quality tools are designed for most standard reaming needs.

Specifications					Price Each				
Diameter	Decimal Equivalent	Flute Length	Overall Length	Shank Diameter	LV533 Straight Flute	LV535 RH Spiral	LV535L LH Spiral RH Cut	1533 Cobalt Str. Flt.	1535 Cobalt RH Spiral
27mm	1.0630	2 7/8	11	.8745	135.00	—	—	—	—
1 3/32	1.0938	2 7/8	11	.8745	119.00	140.00	150.00	—	—
28.5mm	1.1220	2 7/8	11	.8745	148.00	—	—	—	—
1 1/8	1.1250	2 7/8	11	.8745	95.00	108.00	117.50	153.00	—
29mm	1.1417	2 7/8	11	.8745	170.00	—	—	—	—
1 5/32	1.1562	2 7/8	11	.9995	142.00	155.00	—	—	—
30mm	1.1811	2 7/8	11	.9995	142.00	—	—	—	—
1 3/16	1.1875	2 7/8	11	.9995	115.00	126.00	137.00	176.00	—
1 7/32	1.2188	2 7/8	11 1/2	.9995	144.00	160.00	172.00	—	—
31mm	1.2205	2 7/8	11 1/2	.9995	162.90	—	—	—	—
1 1/4	1.2500	3	11 1/2	.9995	119.70	136.00	146.00	188.00	—
1 9/32	1.2812	3	11 1/2	.9995	162.90	175.00	—	—	—
1 5/16	1.3125	3	11 1/2	.9995	140.00	160.00	170.00	220.00	—
1 11/32	1.3438	3 1/4	12	.9995	155.00	172.00	188.00	—	—
Under 1 3/8	1.3740	3 1/4	12	.9995	180.00	—	—	—	310.00
1 3/8	1.3750	3 1/4	12	.9995	146.70	169.00	179.00	230.00	—
1 13/32	1.4062	3 1/4	12	1.2495	180.00	197.00	—	—	—
1 7/16	1.4375	3 1/4	12	1.2495	157.00	180.00	196.36	249.00	—
1 15/32	1.4688	3 1/2	12 1/2	1.2495	191.00	208.00	—	—	—
1 1/2	1.5000	3 1/2	12 1/2	1.2495	170.00	195.00	206.00	269.00	—
1 9/16	1.5625	3 1/2	12 1/2	1.2495	240.00	280.00	295.00	—	—
1 5/8	1.6250	3 5/8	13	1.2495	245.00	285.00	295.00	—	—
1 11/16	1.6875	3 5/8	13	1.2495	277.00	315.00	—	—	—
1 3/4	1.7500	4	13 1/2	1.2495	277.00	—	—	—	—
1 7/8	1.8750	4	14	1.4995	318.00	—	—	—	—
1 15/16	1.9375	4	14	1.4995	—	—	449.00	—	—
2	2.0000	4	14	1.4995	370.00	—	453.00	—	—

Diameter Tolerance: 1" Through 2" +.0002" +.005m/m
+.0006" +.015m/m

Chucking Reamer Sets

Fractional Sets These sets provide a method of maintaining a complete stock of reamers in ranges to suit your requirements. A set on a machinist's workbench saves many trips to the tool crib.

Description	Sizes	Pieces	Case Type	Set No.	Price
H.S. Straight Flute	1/16 – 1/4 by 64 th s	13	Wood	LV533-6W	264.67
H.S. Straight Flute	1/16 – 1/4 by 64 th s	13	Plastic	LV533-6P	207.67
H.S. Straight Flute	1/16 – 1/2 by 32 ^{nds}	15	Plastic	LV533-42P	309.92
H.S. Straight Flute	1/16 – 3/8 by 64 th s	21	Plastic	LV533-40P	388.22
H.S. Straight Flute	1/16 – 1/2 by 64 th s	29	Wood	LV533-8W	664.72
H.S. Straight Flute	1/16 – 1/2 by 64 th s	29	Plastic	LV533-8P	607.72
H.S. Straight Flute	1/16 – 1/2 by 64 th s	29	Metal	LV533-8M	630.22
H.S. RH Spiral	1/16 – 1/4 by 64 th s	13	Wood	LV535-1W	298.90
H.S. RH Spiral	1/16 – 1/4 by 64 th s	13	Plastic	LV535-1P	241.90
H.S. RH Spiral	1/16 – 1/2 by 32 ^{nds}	15	Plastic	LV535-43P	352.33
H.S. RH Spiral	1/16 – 3/8 by 64 th s	21	Plastic	LV535-41P	438.83
H.S. RH Spiral	1/16 – 1/2 by 64 th s	29	Wood	LV535-3W	740.93
H.S. RH Spiral	1/16 – 1/2 by 64 th s	29	Metal	LV535-3M	706.43
H.S. RH Spiral	1/16 – 1/2 by 64 th s	29	Plastic	LV535-3P	683.93
H.S. LH Spiral	1/16 – 1/2 by 64 th s	29	Wood	LV535L-4W	821.40
H.S. LH Spiral	1/16 – 1/2 by 64 th s	29	Plastic	LV535L-4P	764.40
Cobalt Straight Flute	1/16 – 1/2 by 64 th s	29	Wood	1533-C8W	1027.00
Cobalt Straight Flute	1/16 – 1/2 by 64 th s	29	Metal	1533-C8M	992.50
Cobalt Straight Flute	1/16 – 1/2 by 64 th s	29	Plastic	1533-C8P	970.00
Cobalt RH Spiral	1/16 – 1/2 by 64 th s	29	Wood	1535-C3W	1068.47
Cobalt RH Spiral	1/16 – 1/2 by 64 th s	29	Metal	1535-C3M	1033.97



LV533-6W



LV533-42P



LV533-8M

Chuckling Reamers & Sets

Chucking Reamer Sets

These sets provide a method of maintaining a complete stock of reamers in ranges to suit your requirements. A set on a machinist's workbench saves many trips to the tool crib.



LV533-6W



LV533-8M



LV533-42P

Wire Gauge Sets

Description	Sizes	Pieces	Case Type	Set No.	Price
H.S. Straight Flute	#1 - #60	60	Wood	LV533-13W	987.00
H.S. Straight Flute	#1 - #60	60	Metal	LV533-13M	945.00
H.S. Straight Flute	#1 - #60	60	Plastic	LV533-13P	931.57
H.S. Straight Flute	#61 - #80	20	Metal	LV533-15M	348.75
H.S. RH Spiral	#1 - #60	60	Wood	LV535-10W	1113.90
H.S. RH Spiral	#1 - #60	60	Metal	LV535-10M	1084.60
H.S. RH Spiral	#1 - #60	60	Plastic	LV535-10P	1059.47
H.S. LH Spiral	#1 - #60	60	Wood	LV535L-11W	1247.70
H.S. LH Spiral	#1 - #60	60	Plastic	LV535L-11P	1192.27
Cobalt Straight Flute	#1 - #60	60	Wood	1533-C13W	1319.50
Cobalt Straight Flute	#1 - #60	60	Metal	1533-C13M	1227.50
Cobalt Straight Flute	#1 - #60	60	Plastic	1533-C13P	1264.07

Letter Sets

Description	Sizes	Pieces	Case Type	Set No.	Price
H.S. Straight Flute	A - Z	26	Wood	LV533-23W	651.85
H.S. Straight Flute	A - Z	26	Metal	LV533-23M	617.35
H.S. Straight Flute	A - Z	26	Plastic	LV533-23P	594.85
Cobalt Straight Flute	A - Z	26	Wood	1533-C23W	983.50
Cobalt Straight Flute	A - Z	26	Metal	1533-C23M	949.00
Cobalt Straight Flute	A - Z	26	Plastic	1533-C23P	926.50

Metric Sets

Description	Sizes	Pieces	Case Type	Set No.	Price
H.S. Straight Flute	1mm - 7mm by .5	13	Wood	LV533-16W	238.60
H.S. Straight Flute	1mm - 7mm by .5	13	Plastic	LV533-16P	181.60
H.S. Straight Flute	1mm - 13mm by .5	25	Plastic	LV533-17P	542.25

Over & Under Sets

Description	Sizes	Pieces	Case Type	Set No.	Price
H.S. Straight Flute	.1240 - .5010	14	Wood	LV533-32W	357.70
H.S. Straight Flute	.1240 - .5010	14	Metal	LV533-32M	323.20
H.S. Straight Flute	.1240 - .5010	14	Plastic	LV533-32P	300.70
H.S. RH Spiral	.1240 - .5010	14	Wood	LV535-30W	399.50
H.S. RH Spiral	.1240 - .5010	14	Plastic	LV535-30P	342.50
H.S. LH Spiral	.1240 - .5010	14	Wood	LV535L-31W	447.00
H.S. LH Spiral	.1240 - .5010	14	Plastic	LV535L-31P	390.00
Cobalt Straight Flute	.1240 - .5010	14	Wood	1533-C32W	544.50
Cobalt Straight Flute	.1240 - .5010	14	Plastic	1533-C32P	487.50
Cobalt RH Spiral	.1240 - .5010	14	Wood	1535-C32W	566.80
Cobalt RH Spiral	.1240 - .5010	14	Plastic	1535-C32P	509.80

Diameter Tolerance:	Through 1/2"	-0.0000" -0.000m/m +0.0002" +0.005m/m	1/2" Through 5/8"	-0.0000" -0.000m/m +0.0003" +0.008m/m
----------------------------	--------------	--	-------------------	--

Chucking Reamers - Straight Shank - H.S. & Cobalt

Intermediate Decimal Sizes

List No. **LV533**: High Speed, Straight Flute

List No. **LV535**: High Speed, Right Hand Spiral, Right Hand Cut

List No. **LV535L**: High Speed, Left Hand Spiral, Right Hand Cut

List No. **1533**: Cobalt, Straight Flute

List No. **1535**: Cobalt, Right Hand Spiral, Right Hand Cut



Size	Price Each				
	LV533 Straight Flute	LV535 RH Spiral	LV535L LH Sp. RH Cut	1533 Cobalt Str. Fit.	1535 Cobalt RH Sp.
.0355	28.00	----	----	----	----
.0405	24.80	27.00	30.00	----	----
.0415	24.80	27.00	30.00	----	----
.0425	24.80	27.00	30.00	----	----
.0435	24.80	27.00	30.00	----	----
.0440	24.80	27.00	30.00	----	----
.0445	24.80	27.00	30.00	----	----
.0450	24.80	27.00	30.00	----	----
.0455	24.80	27.00	30.00	----	----
.0460	24.80	27.00	30.00	----	----
.0470	24.80	27.00	30.00	38.00	----
.0475	24.80	27.00	30.00	----	----
.0480	24.80	27.00	30.00	----	----
.0485	24.80	27.00	30.00	----	----
.0490	24.80	27.00	30.00	38.00	----
.0495	24.80	27.00	30.00	----	----
.0500	24.80	27.00	30.00	----	----
.0505	24.80	27.00	30.00	38.00	----
.0510	24.80	27.00	30.00	----	----
.0512	28.00	----	----	57.00	----
.0514	28.00	----	----	----	----
.0515	24.80	27.00	30.00	38.00	----
.0525	24.80	27.00	30.00	----	----
.0530	24.80	27.00	30.00	----	----
.0535	24.80	27.00	30.00	----	----
.0540	24.80	27.00	30.00	----	----
.0545	24.80	27.00	30.00	----	----
.0555	24.80	27.00	30.00	----	----
.0560	24.80	27.00	30.00	----	----
.0565	24.80	27.00	30.00	----	----
.0570	24.80	27.00	30.00	----	----
.0575	24.80	27.00	30.00	----	----
.0580	24.80	27.00	30.00	----	----
.0585	24.80	27.00	30.00	----	----
.0590	24.80	27.00	30.00	----	----
.0600	24.80	27.00	30.00	----	----
.0605	24.80	27.00	30.00	----	----
.0610	24.80	27.00	30.00	51.94	57.13
.0615	24.80	27.00	30.00	----	----
.0620	24.80	27.00	30.00	51.94	----
.0623	28.00	33.00	----	----	----
.0628	28.00	----	----	57.00	----
.0630	24.80	27.00	30.00	51.94	57.13
.0637	28.00	----	----	----	----
.0640	24.80	27.00	30.00	51.94	57.13
.0645	24.80	27.00	30.00	51.94	57.13
.0650	24.80	27.00	30.00	51.94	57.13
.0655	24.80	27.00	30.00	51.94	57.13
.0660	24.80	27.00	30.00	51.94	57.13
.0665	24.80	27.00	30.00	51.94	57.13
.0675	24.80	27.00	30.00	51.94	57.13
.0680	24.80	27.00	30.00	51.94	57.13
.0685	24.80	27.00	30.00	51.94	57.13
.0690	24.80	27.00	30.00	51.94	57.13
.0695	24.80	27.00	30.00	51.94	57.13
.0702	28.00	----	----	----	----
.0705	24.80	27.00	30.00	51.94	57.13
.0710	24.80	27.00	30.00	51.94	57.13
.0715	24.80	27.00	30.00	51.94	57.13

Size	Price Each				
	LV533 Straight Flute	LV535 RH Spiral	LV535L LH Sp. RH Cut	1533 Cobalt Str. Fit.	1535 Cobalt RH Sp.
.0720	24.80	27.00	30.00	51.94	57.13
.0725	24.80	27.00	30.00	51.94	57.13
.0727	28.00	----	----	----	----
.0735	24.80	27.00	30.00	51.94	57.13
.0740	24.80	27.00	30.00	51.94	57.13
.0745	24.80	27.00	30.00	51.94	57.13
.0750	24.80	27.00	30.00	51.94	57.13
.0755	24.80	27.00	30.00	51.94	57.13
.0763	28.00	----	----	----	----
.0764	28.00	----	----	----	----
.0765	24.80	27.00	30.00	51.94	57.13
.0766	28.00	----	----	----	----
.0769	28.00	----	----	----	----
.0770	24.80	27.00	30.00	51.94	57.13
.0775	24.80	27.00	30.00	51.94	57.13
.0780	24.80	27.00	30.00	51.94	57.13
.0790	24.80	27.00	30.00	51.94	57.13
.0791	18.70	----	----	----	----
.0795	24.80	27.00	30.00	51.94	57.13
.0798	28.00	----	----	----	----
.0799	28.00	----	----	----	----
.0800	24.80	27.00	30.00	51.94	57.13
.0801	28.00	----	----	----	----
.0803	28.00	----	----	----	----
.0805	24.80	27.00	30.00	51.94	57.13
.0815	24.80	27.00	30.00	51.94	57.13
.0825	24.80	27.00	30.00	51.94	57.13
.0830	24.80	27.00	30.00	51.94	57.13
.0835	24.80	27.00	30.00	51.94	57.13
.0840	24.80	27.00	30.00	51.94	57.13
.0845	24.80	27.00	30.00	51.94	57.13
.0850	24.80	27.00	30.00	51.94	57.13
.0855	24.80	27.00	30.00	51.94	57.13
.0865	24.80	27.00	30.00	51.94	57.13
.0870	24.80	27.00	30.00	51.94	57.13
.0875	24.80	27.00	30.00	51.94	57.13
.0880	24.80	27.00	30.00	51.94	57.13
.0882	28.00	----	----	----	----
.0885	24.80	27.00	30.00	51.94	57.13
.0895	24.80	27.00	30.00	51.94	57.13
.0897	28.00	----	----	----	----
.0900	24.80	27.00	30.00	51.94	57.13
.0905	24.80	27.00	30.00	51.94	57.13
.0910	24.80	27.00	30.00	51.94	57.13
.0915	24.80	27.00	30.00	51.94	57.13
.0917	28.00	----	----	----	----
.0918	28.00	----	----	----	----
.0920	24.80	27.00	30.00	51.94	57.13
.0923	28.00	----	----	----	----
.0925	24.80	27.00	30.00	51.94	57.13
.0927	28.00	33.00	----	----	----
.0928	28.00	----	----	57.00	----
.0929	28.00	----	----	----	----
.0930	24.80	27.00	30.00	51.94	57.13
.0931	28.00	----	----	----	----
.0932	28.00	----	----	57.00	----
.0933	28.00	33.00	----	57.00	----
.0937	28.00	----	----	57.00	----
.0940	24.80	27.00	30.00	51.94	57.13

Note: Tolerance, Flute Length, Overall Length, and Shank Diameter are comparable to the closest standard size. See pages 4-9.

Chucking Reamers - Straight Shank - H.S. & Cobalt

Intermediate Decimal Sizes

- List No. **LV533**: High Speed, Straight Flute
- List No. **LV535**: High Speed, Right Hand Spiral, Right Hand Cut
- List No. **LV535L**: High Speed, Left Hand Spiral, Right Hand Cut
- List No. **1533**: Cobalt, Straight Flute
- List No. **1535**: Cobalt, Right Hand Spiral, Right Hand Cut



Decimal Chucking Reamers

Size	Price Each				
	LV533 Straight Flute	LV535 RH Spiral	LV535L LH Sp. RH Cut	1533 Cobalt Str. Fit.	1535 Cobalt RH Sp.
.0942	28.00	33.00	----	57.00	----
.0943	28.00	----	----	57.00	----
.0944	28.00	----	----	----	----
.0945	24.80	27.00	30.00	51.94	57.13
.0947	28.00	33.00	----	----	----
.0950	24.80	27.00	30.00	51.94	57.13
.0953	28.00	----	----	----	----
.0955	24.80	27.00	30.00	51.94	57.13
.0965	24.80	27.00	30.00	51.94	57.13
.0967	28.00	----	----	----	----
.0968	28.00	----	----	----	----
.0969	28.00	----	----	----	----
.0970	24.80	27.00	30.00	51.94	57.13
.0971	28.00	----	----	----	----
.0972	28.00	----	----	----	----
.0975	24.80	27.00	30.00	51.94	57.13
.0976	28.00	----	----	----	----
.0977	28.00	----	----	57.00	----
.0985	24.80	27.00	30.00	51.94	57.13
.0988	28.00	----	----	57.00	----
.0990	24.80	27.00	30.00	51.94	57.13
.1000	24.80	27.00	30.00	51.94	57.13
.1002	28.00	----	----	----	----
.1004	28.00	----	----	----	----
.1005	24.80	27.00	30.00	51.94	57.13
.1008	28.00	----	----	----	----
.1010	24.80	27.00	30.00	51.94	57.13
.1011	28.00	----	----	----	----
.1020	24.80	27.00	30.00	51.94	57.13
.1023	28.00	----	----	----	----
.1025	24.80	27.00	30.00	51.94	57.13
.1027	28.00	----	----	----	----
.1030	24.80	27.00	30.00	51.94	57.13
.1035	24.80	27.00	30.00	51.94	57.13
.1045	24.80	27.00	30.00	51.94	57.13
.1048	28.00	----	----	----	----
.1050	24.80	27.00	30.00	51.94	57.13
.1055	24.80	27.00	30.00	51.94	57.13
.1057	28.00	----	----	----	----
.1060	24.80	27.00	30.00	51.94	57.13
.1062	28.00	----	----	----	----
.1070	24.80	27.00	30.00	51.94	57.13
.1075	24.80	27.00	30.00	51.94	57.13
.1078	28.00	----	----	----	----
.1080	24.80	27.00	30.00	51.94	57.13
.1082	28.00	----	----	----	----
.1085	24.80	27.00	30.00	51.94	57.13
.1087	28.00	----	----	----	----
.1090	24.80	27.00	30.00	51.94	57.13
.1092	28.00	----	----	----	----
.1095	21.40	24.50	28.00	51.94	57.13
.1105	21.40	24.50	28.00	51.94	57.13
.1115	21.40	24.50	28.00	51.94	57.13
.1120	21.40	24.50	28.00	51.94	57.13
.1122	28.00	----	----	----	----
.1125	21.40	24.50	28.00	51.94	57.13
.1135	21.40	24.50	28.00	51.94	57.13
.1140	21.40	24.50	28.00	51.94	57.13
.1145	21.40	24.50	28.00	51.94	57.13

Size	Price Each				
	LV533 Straight Flute	LV535 RH Spiral	LV535L LH Sp. RH Cut	1533 Cobalt Str. Fit.	1535 Cobalt RH Sp.
.1150	21.40	24.50	28.00	51.94	57.13
.1155	21.40	24.50	28.00	51.94	57.13
.1157	28.00	----	----	----	----
.1165	21.40	24.50	28.00	51.94	57.13
.1169	28.00	33.00	----	----	----
.1170	21.40	24.50	28.00	51.94	57.13
.1171	15.95	----	----	----	----
.1173	28.00	----	----	----	----
.1175	21.40	24.50	28.00	51.94	57.13
.1177	28.00	----	----	----	----
.1178	28.00	----	----	57.00	----
.1180	21.40	24.50	28.00	51.94	57.13
.1185	21.40	24.50	28.00	51.94	57.13
.1190	21.40	24.50	28.00	51.94	57.13
.1191	15.95	----	----	----	----
.1192	28.00	----	----	----	----
.1193	28.00	----	----	----	----
.1195	21.40	24.50	28.00	51.94	57.13
.1197	28.00	----	----	----	----
.1198	28.00	----	----	----	----
.1201	28.00	----	----	----	----
.1202	28.00	----	----	----	----
.1204	28.00	----	----	----	----
.1205	21.40	24.50	28.00	51.94	57.13
.1208	28.00	----	----	----	----
.1210	21.40	24.50	28.00	51.94	57.13
.1213	28.00	----	----	----	----
.1215	21.40	24.50	28.00	51.94	57.13
.1220	21.40	24.50	28.00	51.94	57.13
.1223	28.00	----	----	----	----
.1224	28.00	----	----	----	----
.1225	21.40	24.50	28.00	51.94	57.13
.1227	28.00	----	----	----	----
.1228	28.00	----	----	----	----
.1230	21.40	24.50	28.00	51.94	57.13
.1235	21.40	24.50	28.00	51.94	57.13
.1237	28.00	----	----	57.00	----
.1238	28.00	----	----	----	----
.1239	28.00	----	----	----	----
.1240	12.90	14.80	16.20	18.00	19.00
.1243	28.00	33.00	----	----	----
.1245	21.40	24.50	28.00	51.94	57.13
.1246	28.00	----	----	----	----
.1247	33.00	38.00	----	57.00	62.50
.1248	28.00	----	----	----	----
.1249	28.00	----	----	57.00	----
.1251	33.00	----	----	57.00	----
.1252	33.00	----	----	57.00	----
.1253	33.00	----	----	57.00	----
.1254	33.00	38.00	----	57.00	----
.1255	25.70	29.50	33.75	53.56	58.91
.1257	33.00	----	----	57.00	----
.1258	33.00	----	----	----	----
.1260	12.90	14.80	16.20	18.00	19.00
.1261	33.00	----	----	----	----
.1262	33.00	----	----	----	----
.1264	33.00	----	----	----	----
.1265	25.70	29.50	33.75	53.56	58.91
.1267	33.00	----	----	----	----

Note: Tolerance, Flute Length, Overall Length, and Shank Diameter are comparable to the closest standard size. See pages 4-9.

Chucking Reamers - Straight Shank - H.S. & Cobalt

Intermediate Decimal Sizes

List No. **LV533**: High Speed, Straight Flute

List No. **LV535**: High Speed, Right Hand Spiral, Right Hand Cut

List No. **LV535L**: High Speed, Left Hand Spiral, Right Hand Cut

List No. **1533**: Cobalt, Straight Flute

List No. **1535**: Cobalt, Right Hand Spiral, Right Hand Cut



Size	Price Each				
	LV533 Straight Flute	LV535 RH Spiral	LV535L LH Sp. RH Cut	1533 Cobalt Str. Flt.	1535 Cobalt RH Sp.
.1270	25.70	29.50	33.75	53.56	58.91
.1272	33.00	----	----	----	----
.1273	33.00	----	----	----	----
.1274	33.00	----	----	----	----
.1275	25.70	29.50	33.75	53.56	58.91
.1280	25.70	29.50	33.75	53.56	58.91
.1287	33.00	----	----	----	----
.1290	25.70	29.50	33.75	53.56	58.91
.1291	33.00	----	----	----	----
.1295	25.70	29.50	33.75	53.56	58.91
.1297	33.00	----	----	----	----
.1300	25.70	29.50	33.75	53.56	58.91
.1305	25.70	29.50	33.75	53.56	58.91
.1307	33.00	----	----	----	----
.1310	25.70	29.50	33.75	53.56	58.91
.1315	25.70	29.50	33.75	53.56	58.91
.1320	25.70	29.50	33.75	53.56	58.91
.1322	33.00	----	----	----	----
.1325	25.70	29.50	33.75	53.56	58.91
.1330	25.70	29.50	33.75	53.56	58.91
.1335	25.70	29.50	33.75	53.56	58.91
.1340	25.70	29.50	33.75	53.56	58.91
.1345	25.70	29.50	33.75	53.56	58.91
.1350	25.70	29.50	33.75	53.56	58.91
.1354	33.00	----	----	----	----
.1355	25.70	29.50	33.75	53.56	58.91
.1364	33.00	----	----	----	----
.1365	25.70	29.50	33.75	53.56	58.91
.1370	25.70	29.50	33.75	53.56	58.91
.1374	33.00	----	----	----	----
.1375	25.70	29.50	33.75	53.56	58.91
.1376	33.00	----	----	----	----
.1377	33.00	----	----	----	----
.1380	25.70	29.50	33.75	53.56	58.91
.1382	33.00	----	----	----	----
.1383	33.00	----	----	----	----
.1385	25.70	29.50	33.75	53.56	58.91
.1386	33.00	38.00	----	----	----
.1390	25.70	29.50	33.75	53.56	58.91
.1392	33.00	----	----	----	----
.1393	33.00	----	----	----	----
.1395	25.70	29.50	33.75	53.56	58.91
.1396	18.90	----	----	----	----
.1397	33.00	----	----	----	----
.1398	33.00	----	----	----	----
.1399	33.00	----	----	----	----
.1400	25.70	29.50	33.75	53.56	58.91
.1402	33.00	----	----	----	----
.1407	33.00	----	----	----	----
.1408	33.00	----	----	----	----
.1409	33.00	----	----	----	----
.1410	25.70	29.50	33.75	53.56	58.91
.1411	33.00	----	----	----	----
.1414	33.00	----	----	----	----
.1415	25.70	29.50	33.75	53.56	58.91
.1416	18.90	----	----	----	----
.1420	25.70	29.50	33.75	53.56	58.91
.1424	33.00	----	----	----	----
.1425	25.70	29.50	33.75	53.56	58.91

Size	Price Each				
	LV533 Straight Flute	LV535 RH Spiral	LV535L LH Sp. RH Cut	1533 Cobalt Str. Flt.	1535 Cobalt RH Sp.
.1427	33.00	----	----	----	----
.1430	25.70	29.50	33.75	53.56	58.91
.1432	33.00	----	----	----	----
.1435	25.70	29.50	33.75	53.56	58.91
.1438	33.00	----	----	----	----
.1442	33.00	----	----	----	----
.1443	33.00	----	----	----	----
.1445	25.70	29.50	33.75	53.56	58.91
.1448	33.00	----	----	----	----
.1449	33.00	----	----	----	----
.1450	25.70	29.50	33.75	53.56	58.91
.1452	33.00	----	----	----	----
.1455	25.70	29.50	33.75	53.56	58.91
.1456	33.00	----	----	----	----
.1457	33.00	----	----	----	----
.1460	25.70	29.50	33.75	53.56	58.91
.1462	33.00	----	----	----	----
.1465	25.70	29.50	33.75	53.56	58.91
.1472	33.00	----	----	----	----
.1475	25.70	29.50	33.75	53.56	58.91
.1480	25.70	29.50	33.75	53.56	58.91
.1485	25.70	29.50	33.75	53.56	58.91
.1490	25.70	29.50	33.75	53.56	58.91
.1497	33.00	----	----	----	----
.1498	33.00	----	----	----	----
.1500	25.70	29.50	33.75	53.56	58.91
.1502	33.00	----	----	----	----
.1503	33.00	----	----	----	----
.1504	33.00	----	----	----	----
.1505	25.70	29.50	33.75	53.56	58.91
.1506	33.00	----	----	----	----
.1510	25.70	29.50	33.75	53.56	58.91
.1512	33.00	38.00	----	----	----
.1515	25.70	29.50	33.75	53.56	58.91
.1516	33.00	----	----	----	----
.1525	25.70	29.50	33.75	53.56	58.91
.1530	25.70	29.50	33.75	53.56	58.91
.1532	33.00	----	----	----	----
.1535	25.70	29.50	33.75	53.56	58.91
.1542	33.00	----	----	----	----
.1543	33.00	----	----	----	----
.1545	25.70	29.50	33.75	53.56	58.91
.1550	25.70	29.50	33.75	53.56	58.91
.1552	18.90	----	----	----	----
.1553	33.00	----	----	----	----
.1555	25.70	29.50	33.75	53.56	58.91
.1556	33.00	----	----	----	----
.1560	25.70	29.50	33.75	53.56	58.91
.1565	25.70	29.50	33.75	53.56	58.91
.1566	33.00	----	----	----	----
.1567	33.00	----	----	----	----
.1572	18.90	----	----	28.00	----
.1579	33.00	----	----	----	----
.1580	25.70	29.50	33.75	53.56	58.91
.1585	25.70	29.50	33.75	53.56	58.91
.1591	33.00	----	----	----	----
.1595	25.70	29.50	33.75	53.56	58.91
.1596	33.00	----	----	----	----
.1598	33.00	----	----	----	----

Note: Tolerance, Flute Length, Overall Length, and Shank Diameter are comparable to the closest standard size. See pages 4-9.

Chucking Reamers - Straight Shank - H.S. & Cobalt

Intermediate Decimal Sizes

- List No. **LV533**: High Speed, Straight Flute
- List No. **LV535**: High Speed, Right Hand Spiral, Right Hand Cut
- List No. **LV535L**: High Speed, Left Hand Spiral, Right Hand Cut
- List No. **1533**: Cobalt, Straight Flute
- List No. **1535**: Cobalt, Right Hand Spiral, Right Hand Cut



Decimal Chucking Reamers

Size	Price Each				
	LV533 Straight Flute	LV535 RH Spiral	LV535L LH Sp. RH Cut	1533 Cobalt Str. Flt.	1535 Cobalt RH Sp.
.1600	25.70	29.50	33.75	53.56	58.91
.1605	25.70	29.50	33.75	53.56	58.91
.1615	25.70	29.50	33.75	53.56	58.91
.1617	33.00	----	----	----	----
.1620	25.70	29.50	33.75	53.56	58.91
.1625	25.70	29.50	33.75	53.56	58.91
.1630	25.70	29.50	33.75	53.56	58.91
.1635	25.70	29.50	33.75	53.56	58.91
.1640	25.70	29.50	33.75	53.56	58.91
.1645	25.70	29.50	33.75	53.56	58.91
.1647	33.00	----	----	64.00	----
.1650	25.70	29.50	33.75	53.56	58.91
.1655	25.70	29.50	33.75	53.56	58.91
.1665	25.70	29.50	33.75	53.56	58.91
.1670	25.70	29.50	33.75	53.56	58.91
.1675	25.70	29.50	33.75	53.56	58.91
.1680	25.70	29.50	33.75	53.56	58.91
.1685	25.70	29.50	33.75	53.56	58.91
.1690	25.70	29.50	33.75	53.56	58.91
.1700	25.70	29.50	33.75	53.56	58.91
.1701	33.00	----	----	----	----
.1705	25.70	29.50	33.75	53.56	58.91
.1710	25.70	29.50	33.75	53.56	58.91
.1715	25.70	29.50	33.75	53.56	58.91
.1720	25.70	29.50	33.75	53.56	58.91
.1725	25.70	29.50	33.75	53.56	58.91
.1734	33.00	----	----	----	----
.1735	25.70	29.50	33.75	53.56	58.91
.1740	25.70	29.50	33.75	53.56	58.91
.1745	25.70	29.50	33.75	53.56	58.91
.1750	25.70	29.50	33.75	53.56	58.91
.1755	25.70	29.50	33.75	53.56	58.91
.1760	25.70	29.50	33.75	53.56	58.91
.1765	25.70	29.50	33.75	53.56	58.91
.1775	25.70	29.50	33.75	53.56	58.91
.1780	25.70	29.50	33.75	53.56	58.91
.1785	25.70	29.50	33.75	53.56	58.91
.1786	33.00	----	----	----	----
.1790	25.70	29.50	33.75	53.56	58.91
.1795	25.70	29.50	33.75	53.56	58.91
.1802	33.00	----	----	59.00	----
.1805	25.70	29.50	33.75	53.56	58.91
.1806	33.00	----	----	----	----
.1810	25.70	29.50	33.75	53.56	58.91
.1813	33.00	----	----	----	----
.1815	25.70	29.50	33.75	53.56	58.91
.1818	33.00	----	----	----	----
.1822	33.00	----	----	----	----
.1825	25.70	29.50	33.75	53.56	58.91
.1830	25.70	29.50	33.75	53.56	58.91
.1835	25.70	29.50	33.75	53.56	58.91
.1840	25.70	29.50	33.75	53.56	58.91
.1845	25.70	29.50	33.75	53.56	58.91
.1855	25.70	29.50	33.75	53.56	58.91
.1856	33.00	----	----	----	----
.1857	33.00	----	----	----	----
.1860	25.70	29.50	33.75	53.56	58.91
.1865	16.30	18.80	21.50	22.00	23.50
.1866	33.00	----	----	----	----

Size	Price Each				
	LV533 Straight Flute	LV535 RH Spiral	LV535L LH Sp. RH Cut	1533 Cobalt Str. Flt.	1535 Cobalt RH Sp.
.1867	33.00	----	----	----	----
.1868	33.00	----	----	----	----
.1870	25.70	29.50	33.75	56.48	62.12
.1872	33.00	----	----	59.00	62.12
.1873	33.00	----	----	----	----
.1877	33.00	----	----	59.00	62.12
.1880	25.70	29.50	33.75	56.48	62.12
.1882	33.00	38.00	----	----	----
.1883	33.00	----	----	----	----
.1885	16.30	18.80	21.50	22.00	23.50
.1887	33.00	----	----	----	----
.1895	25.70	29.50	33.75	56.48	62.12
.1897	33.00	----	----	----	----
.1900	25.70	29.50	33.75	56.48	62.12
.1905	25.70	29.50	33.75	56.48	62.12
.1915	25.70	29.50	33.75	56.48	62.12
.1920	25.70	29.50	33.75	56.48	62.12
.1925	25.70	29.50	33.75	56.48	62.12
.1930	25.70	29.50	33.75	56.48	62.12
.1940	25.70	29.50	33.75	56.48	62.12
.1945	25.70	29.50	33.75	56.48	62.12
.1950	25.70	29.50	33.75	56.48	62.12
.1952	33.00	----	----	----	----
.1954	33.00	----	----	----	----
.1955	25.70	29.50	33.75	56.48	62.12
.1958	33.00	----	----	----	----
.1959	33.00	----	----	----	----
.1965	25.70	29.50	33.75	56.48	62.12
.1966	33.00	----	----	----	----
.1970	25.70	29.50	33.75	56.48	62.12
.1972	33.00	----	----	----	----
.1974	33.00	----	----	----	----
.1975	25.70	29.50	33.75	56.48	62.12
.1979	33.00	----	----	----	----
.1980	25.70	29.50	33.75	56.48	62.12
.1982	33.00	----	----	----	----
.1985	25.70	29.50	33.75	56.48	62.12
.1995	25.70	29.50	33.75	56.48	62.12
.2000	25.70	29.50	33.75	56.48	62.12
.2005	25.70	29.50	33.75	56.48	62.12
.2015	25.70	29.50	33.75	56.48	62.12
.2016	33.00	----	----	----	----
.2018	33.00	----	----	----	----
.2020	25.70	29.50	33.75	56.48	62.12
.2025	25.70	29.50	33.75	56.48	62.12
.2030	25.70	29.50	33.75	56.48	62.12
.2035	25.70	29.50	33.75	56.48	62.12
.2045	25.70	29.50	33.75	56.48	62.12
.2050	25.70	29.50	33.75	56.48	62.12
.2060	25.70	29.50	33.75	56.48	62.12
.2065	25.70	29.50	33.75	56.48	62.12
.2070	25.70	29.50	33.75	56.48	62.12
.2075	25.70	29.50	33.75	56.48	62.12
.2080	25.70	29.50	33.75	56.48	62.12
.2085	25.70	29.50	33.75	56.48	62.12
.2095	25.70	29.50	33.75	56.48	62.12
.2100	25.70	29.50	33.75	56.48	62.12
.2105	25.70	29.50	33.75	56.48	62.12
.2110	25.70	29.50	33.75	56.48	62.12

Note: Tolerance, Flute Length, Overall Length, and Shank Diameter are comparable to the closest standard size. See pages 4-9.

Chucking Reamers - Straight Shank - H.S. & Cobalt

Intermediate Decimal Sizes

List No. **LV533**: High Speed, Straight Flute

List No. **LV535**: High Speed, Right Hand Spiral, Right Hand Cut

List No. **LV535L**: High Speed, Left Hand Spiral, Right Hand Cut

List No. **1533**: Cobalt, Straight Flute

List No. **1535**: Cobalt, Right Hand Spiral, Right Hand Cut



Size	Price Each				
	LV533 Straight Flute	LV535 RH Spiral	LV535L LH Sp. RH Cut	1533 Cobalt Str. Fit.	1535 Cobalt RH Sp.
.2115	25.70	29.50	33.75	56.48	62.12
.2120	25.70	29.50	33.75	56.48	62.12
.2125	25.70	29.50	33.75	56.48	62.12
.2135	25.70	29.50	33.75	56.48	62.12
.2137	33.00	----	----	----	----
.2140	25.70	29.50	33.75	56.48	62.12
.2145	25.70	29.50	33.75	56.48	62.12
.2147	33.00	----	----	----	----
.2150	25.70	29.50	33.75	56.48	62.12
.2155	25.70	29.50	33.75	56.48	62.12
.2158	33.00	----	----	----	----
.2160	25.70	29.50	33.75	56.48	62.12
.2165	18.40	21.00	24.00	25.50	26.50
.2166	33.00	----	----	----	----
.2167	33.00	----	----	----	----
.2170	25.70	29.50	33.75	56.48	62.12
.2175	25.70	29.50	33.75	56.48	62.12
.2178	22.00	----	----	----	----
.2180	25.70	29.50	33.75	56.48	62.12
.2183	33.00	----	----	----	----
.2185	25.70	29.50	33.75	56.48	62.12
.2190	25.70	29.50	33.75	56.48	62.12
.2192	33.00	----	----	----	----
.2195	25.70	29.50	33.75	56.48	62.12
.2197	33.00	----	----	----	----
.2198	22.00	----	----	----	----
.2200	25.70	29.50	33.75	56.48	62.12
.2205	25.70	29.50	33.75	56.48	62.12
.2215	25.70	29.50	33.75	56.48	62.12
.2220	25.70	29.50	33.75	56.48	62.12
.2225	25.70	29.50	33.75	56.48	62.12
.2230	25.70	29.50	33.75	56.48	62.12
.2232	33.00	----	----	----	----
.2235	25.70	29.50	33.75	56.48	62.12
.2240	25.70	29.50	33.75	56.48	62.12
.2244	33.00	----	----	----	----
.2245	25.70	29.50	33.75	56.48	62.12
.2250	25.70	29.50	33.75	56.48	62.12
.2255	25.70	29.50	33.75	56.48	62.12
.2258	33.00	----	----	----	----
.2260	25.70	29.50	33.75	56.48	62.12
.2265	25.70	29.50	33.75	56.48	62.12
.2270	25.70	29.50	33.75	56.48	62.12
.2275	25.70	29.50	33.75	56.48	62.12
.2285	25.70	29.50	33.75	56.48	62.12
.2290	25.70	29.50	33.75	56.48	62.12
.2295	25.70	29.50	33.75	56.48	62.12
.2300	25.70	29.50	33.75	56.48	62.12
.2305	25.70	29.50	33.75	56.48	62.12
.2310	25.70	29.50	33.75	56.48	62.12
.2312	33.00	----	----	----	----
.2315	25.70	29.50	33.75	56.48	62.12
.2320	25.70	29.50	33.75	56.48	62.12
.2325	25.70	29.50	33.75	56.48	62.12
.2330	25.70	29.50	33.75	56.48	62.12
.2335	25.70	29.50	33.75	56.48	62.12
.2345	25.70	29.50	33.75	56.48	62.12
.2346	33.00	----	----	----	----
.2350	25.70	29.50	33.75	56.48	62.12

Size	Price Each				
	LV533 Straight Flute	LV535 RH Spiral	LV535L LH Sp. RH Cut	1533 Cobalt Str. Fit.	1535 Cobalt RH Sp.
.2355	25.70	29.50	33.75	56.48	62.12
.2360	25.70	29.50	33.75	56.48	62.12
.2365	25.70	29.50	33.75	56.48	62.12
.2367	33.00	----	----	----	----
.2370	25.70	29.50	33.75	56.48	62.12
.2375	25.70	29.50	33.75	56.48	62.12
.2385	25.70	29.50	33.75	56.48	62.12
.2390	25.70	29.50	33.75	56.48	62.12
.2395	25.70	29.50	33.75	56.48	62.12
.2400	25.70	29.50	33.75	56.48	62.12
.2405	25.70	29.50	33.75	56.48	62.12
.2410	25.70	29.50	33.75	56.48	62.12
.2415	25.70	29.50	33.75	56.48	62.12
.2425	25.70	29.50	33.75	56.48	62.12
.2426	33.00	----	----	----	----
.2429	33.00	----	----	----	----
.2430	25.70	29.50	33.75	56.48	62.12
.2435	25.70	29.50	33.75	56.48	62.12
.2437	33.00	----	----	----	----
.2438	33.00	----	----	----	----
.2440	25.70	29.50	33.75	56.48	62.12
.2445	25.70	29.50	33.75	56.48	62.12
.2450	25.70	29.50	33.75	56.48	62.12
.2455	25.70	29.50	33.75	56.48	62.12
.2458	33.00	----	----	----	----
.2462	33.00	----	----	----	----
.2465	25.70	29.50	33.75	56.48	62.12
.2469	33.00	----	----	----	----
.2470	25.70	29.50	33.75	56.48	62.12
.2472	33.00	----	----	----	----
.2475	25.70	29.50	33.75	56.48	62.12
.2480	25.70	29.50	33.75	56.48	62.12
.2485	25.70	29.50	33.75	56.48	62.12
.2490	17.70	21.70	26.00	26.00	27.40
.2495	25.70	29.50	33.75	56.48	62.12
.2497	33.00	----	----	----	----
.2498	33.00	----	----	----	----
.2504	33.00	----	----	----	----
.2505	32.20	36.60	39.90	63.60	69.96
.2510	17.70	21.70	26.00	22.50	27.40
.2515	32.20	36.60	39.90	63.60	69.96
.2520	32.20	36.60	39.90	63.60	69.96
.2524	39.00	----	----	----	----
.2525	32.20	36.60	39.90	63.60	69.96
.2530	32.20	36.60	39.90	63.60	69.96
.2535	32.20	36.60	39.90	63.60	69.96
.2540	32.20	36.60	39.90	63.60	69.96
.2545	32.20	36.60	39.90	63.60	69.96
.2546	39.00	----	----	----	----
.2550	32.20	36.60	39.90	63.60	69.96
.2555	32.20	36.60	39.90	63.60	69.96
.2560	32.20	36.60	39.90	63.60	69.96
.2565	32.20	36.60	39.90	63.60	69.96
.2575	32.20	36.60	39.90	63.60	69.96
.2580	32.20	36.60	39.90	63.60	69.96
.2585	32.20	36.60	39.90	63.60	69.96
.2590	32.20	36.60	39.90	63.60	69.96
.2595	32.20	36.60	39.90	63.60	69.96
.2600	32.20	36.60	39.90	63.60	69.96

Note: Tolerance, Flute Length, Overall Length, and Shank Diameter are comparable to the closest standard size. See pages 4-9.

Chucking Reamers - Straight Shank - H.S. & Cobalt

Intermediate Decimal Sizes

List No. **LV533**: High Speed, Straight Flute

List No. **LV535**: High Speed, Right Hand Spiral, Right Hand Cut

List No. **LV535L**: High Speed, Left Hand Spiral, Right Hand Cut

List No. **1533**: Cobalt, Straight Flute

List No. **1535**: Cobalt, Right Hand Spiral, Right Hand Cut

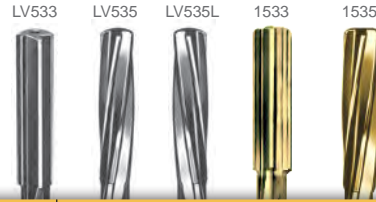

Size	Price Each				
	LV533 Straight Flute	LV535 RH Spiral	LV535L LH Sp. RH Cut	1533 Cobalt Str. Fit.	1535 Cobalt RH Sp.
.2605	32.20	36.60	39.90	63.60	69.96
.2615	32.20	36.60	39.90	63.60	69.96
.2620	32.20	36.60	39.90	63.60	69.96
.2621	39.00	----	----	----	----
.2625	32.20	36.60	39.90	63.60	69.96
.2630	32.20	36.60	39.90	63.60	69.96
.2635	32.20	36.60	39.90	63.60	69.96
.2640	32.20	36.60	39.90	63.60	69.96
.2645	32.20	36.60	39.90	63.60	69.96
.2650	32.20	36.60	39.90	63.60	69.96
.2655	32.20	36.60	39.90	63.60	69.96
.2665	32.20	36.60	39.90	65.08	72.30
.2670	32.20	36.60	39.90	65.08	72.30
.2675	32.20	36.60	39.90	65.08	72.30
.2680	32.20	36.60	39.90	65.08	72.30
.2685	32.20	36.60	39.90	65.08	72.30
.2690	32.20	36.60	39.90	65.08	72.30
.2695	32.20	36.60	39.90	65.08	72.30
.2700	32.20	36.60	39.90	65.08	72.30
.2705	32.20	36.60	39.90	65.08	72.30
.2710	32.20	36.60	39.90	65.08	72.30
.2715	32.20	36.60	39.90	65.08	72.30
.2725	32.20	36.60	39.90	65.08	72.30
.2730	32.20	36.60	39.90	65.08	72.30
.2735	32.20	36.60	39.90	65.08	72.30
.2740	32.20	36.60	39.90	65.08	72.30
.2745	32.20	36.60	39.90	65.08	72.30
.2750	32.20	36.60	39.90	65.08	72.30
.2751	39.00	----	----	----	----
.2755	32.20	36.60	39.90	65.08	72.30
.2760	32.20	36.60	39.90	65.08	72.30
.2761	39.00	----	----	----	----
.2765	32.20	36.60	39.90	65.08	72.30
.2775	32.20	36.60	39.90	65.08	72.30
.2780	32.20	36.60	39.90	65.08	72.30
.2785	32.20	36.60	39.90	65.08	72.30
.2790	32.20	36.60	39.90	65.08	72.30
.2795	32.20	36.60	39.90	65.08	72.30
.2800	32.20	36.60	39.90	65.08	72.30
.2805	32.20	36.60	39.90	65.08	72.30
.2815	32.20	36.60	39.90	66.24	72.86
.2820	32.20	36.60	39.90	66.24	72.86
.2822	39.00	----	----	----	----
.2825	32.20	36.60	39.90	66.24	72.86
.2827	39.00	----	----	----	----
.2830	32.20	36.60	39.90	66.24	72.86
.2834	39.00	----	----	----	----
.2835	32.20	36.60	39.90	66.24	72.86
.2840	32.20	36.60	39.90	66.24	72.86
.2841	39.00	----	----	----	----
.2842	39.00	----	----	----	----
.2845	32.20	36.60	39.90	66.24	72.86
.2850	32.20	36.60	39.90	66.24	72.86
.2855	32.20	36.60	39.90	66.24	72.86
.2860	32.20	36.60	39.90	66.24	72.86
.2862	39.00	----	----	----	----
.2865	32.20	36.60	39.90	66.24	72.86
.2870	32.20	36.60	39.90	66.24	72.86
.2875	32.20	36.60	39.90	66.24	72.86

Size	Price Each				
	LV533 Straight Flute	LV535 RH Spiral	LV535L LH Sp. RH Cut	1533 Cobalt Str. Fit.	1535 Cobalt RH Sp.
.2880	32.20	36.60	39.90	66.24	72.86
.2885	32.20	36.60	39.90	66.24	72.86
.2890	32.20	36.60	39.90	66.24	72.86
.2895	32.20	36.60	39.90	66.24	72.86
.2905	32.20	36.60	39.90	66.24	72.86
.2910	32.20	36.60	39.90	66.24	72.86
.2911	39.00	----	----	----	----
.2915	32.20	36.60	39.90	66.24	72.86
.2916	39.00	----	----	----	----
.2920	32.20	36.60	39.90	66.24	72.86
.2925	32.20	36.60	39.90	66.24	72.86
.2930	32.20	36.60	39.90	66.24	72.86
.2935	32.20	36.60	39.90	66.24	72.86
.2939	39.00	----	----	----	----
.2940	32.20	36.60	39.90	66.24	72.86
.2945	32.20	36.60	39.90	66.24	72.86
.2955	32.20	36.60	39.90	66.24	72.86
.2960	32.20	36.60	39.90	66.24	72.86
.2964	39.00	----	----	----	----
.2965	32.20	36.60	39.90	66.24	72.86
.2970	32.20	36.60	39.90	66.24	72.86
.2975	32.20	36.60	39.90	66.24	72.86
.2977	39.00	----	----	----	----
.2980	32.20	36.60	39.90	66.24	72.86
.2985	32.20	36.60	39.90	66.24	72.86
.2990	32.20	36.60	39.90	66.24	72.86
.2995	32.20	36.60	39.90	66.24	72.86
.3000	32.20	36.60	39.90	66.24	72.86
.3005	32.20	36.60	39.90	66.24	72.86
.3010	32.20	36.60	39.90	66.24	72.86
.3015	32.20	36.60	39.90	66.24	72.86
.3025	32.20	36.60	39.90	66.24	72.86
.3030	32.20	36.60	39.90	66.24	72.86
.3035	32.20	36.60	39.90	66.24	72.86
.3040	32.20	36.60	39.90	66.24	72.86
.3041	39.00	----	----	----	----
.3045	32.20	36.60	39.90	66.24	72.86
.3050	32.20	36.60	39.90	66.24	72.86
.3055	32.20	36.60	39.90	66.24	72.86
.3060	32.20	36.60	39.90	66.24	72.86
.3063	39.00	----	----	----	----
.3065	32.20	36.60	39.90	66.24	72.86
.3070	32.20	36.60	39.90	66.24	72.86
.3073	39.00	----	----	----	----
.3075	32.20	36.60	39.90	66.24	72.86
.3080	32.20	36.60	39.90	66.24	72.86
.3085	32.20	36.60	39.90	66.24	72.86
.3090	32.20	36.60	39.90	66.24	72.86
.3095	32.20	36.60	39.90	66.24	72.86
.3100	32.20	36.60	39.90	66.24	72.86
.3105	32.20	36.60	39.90	66.24	72.86
.3110	32.20	36.60	39.90	66.24	72.86
.3112	39.00	----	----	----	----
.3115	21.00	22.95	27.00	34.00	35.50
.3117	39.00	----	----	----	----
.3120	32.20	36.60	39.90	67.98	74.77
.3122	39.00	----	----	----	----
.3123	39.00	----	----	----	----
.3127	47.00	----	----	----	----

Note: Tolerance, Flute Length, Overall Length, and Shank Diameter are comparable to the closest standard size. See pages 4-9.

Chucking Reamers - Straight Shank - H.S. & Cobalt

Intermediate Decimal Sizes

List No. **LV533**: High Speed, Straight Flute

List No. **LV535**: High Speed, Right Hand Spiral, Right Hand Cut

List No. **LV535L**: High Speed, Left Hand Spiral, Right Hand Cut

List No. **1533**: Cobalt, Straight Flute

List No. **1535**: Cobalt, Right Hand Spiral, Right Hand Cut

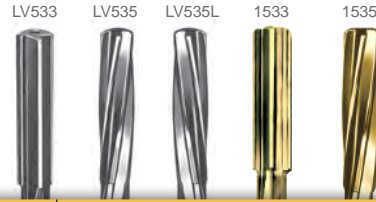

Size	Price Each				
	LV533 Straight Flute	LV535 RH Spiral	LV535L LH Sp. RH Cut	1533 Cobalt Str. Fit.	1535 Cobalt RH Sp.
.3130	37.80	42.00	45.00	67.98	74.77
.3133	47.00	----	----	----	----
.3135	21.00	22.95	27.00	34.00	35.50
.3140	37.80	42.00	45.00	67.98	74.77
.3145	37.80	42.00	45.00	67.98	74.77
.3146	47.00	----	----	----	----
.3154	47.00	----	----	----	----
.3155	37.80	42.00	45.00	67.98	74.77
.3161	47.00	----	----	----	----
.3165	37.80	42.00	45.00	67.98	74.77
.3170	37.80	42.00	45.00	67.98	74.77
.3175	37.80	42.00	45.00	67.98	74.77
.3180	37.80	42.00	45.00	67.98	74.77
.3185	37.80	42.00	45.00	67.98	74.77
.3188	47.00	----	----	----	----
.3190	37.80	42.00	45.00	67.98	74.77
.3195	37.80	42.00	45.00	67.98	74.77
.3200	37.80	42.00	45.00	67.98	74.77
.3205	37.80	42.00	45.00	67.98	74.77
.3210	37.80	42.00	45.00	67.98	74.77
.3215	37.80	42.00	45.00	67.98	74.77
.3220	37.80	42.00	45.00	67.98	74.77
.3225	37.80	42.00	45.00	67.98	74.77
.3235	37.80	42.00	45.00	67.98	74.77
.3240	37.80	42.00	45.00	67.98	74.77
.3245	37.80	42.00	45.00	67.98	74.77
.3250	37.80	42.00	45.00	67.98	74.77
.3255	37.80	42.00	45.00	67.98	74.77
.3260	37.80	42.00	45.00	67.98	74.77
.3265	37.80	42.00	45.00	67.98	74.77
.3270	37.80	42.00	45.00	67.98	74.77
.3271	27.50	----	----	----	----
.3275	37.80	42.00	45.00	67.98	74.77
.3280	37.80	42.00	45.00	67.98	74.77
.3285	37.80	42.00	45.00	67.98	74.77
.3290	37.80	42.00	45.00	67.98	74.77
.3293	47.00	----	----	----	----
.3295	37.80	42.00	45.00	67.98	74.77
.3300	37.80	42.00	45.00	67.98	74.77
.3305	37.80	42.00	45.00	67.98	74.77
.3310	37.80	42.00	45.00	67.98	74.77
.3315	37.80	42.00	45.00	67.98	74.77
.3325	37.80	42.00	45.00	67.98	74.77
.3330	37.80	42.00	45.00	67.98	74.77
.3335	37.80	42.00	45.00	67.98	74.77
.3340	37.80	42.00	45.00	67.98	74.77
.3345	37.80	42.00	45.00	67.98	74.77
.3350	37.80	42.00	45.00	67.98	74.77
.3355	37.80	42.00	45.00	67.98	74.77
.3360	37.80	42.00	45.00	67.98	74.77
.3364	47.00	----	----	----	----
.3365	37.80	42.00	45.00	67.98	74.77
.3370	37.80	42.00	45.00	67.98	74.77
.3375	37.80	42.00	45.00	67.98	74.77
.3380	37.80	42.00	45.00	67.98	74.77
.3385	37.80	42.00	45.00	67.98	74.77
.3395	37.80	42.00	45.00	67.98	74.77
.3400	37.80	42.00	45.00	67.98	74.77
.3405	37.80	42.00	45.00	67.98	74.77

Size	Price Each				
	LV533 Straight Flute	LV535 RH Spiral	LV535L LH Sp. RH Cut	1533 Cobalt Str. Fit.	1535 Cobalt RH Sp.
.3410	37.80	42.00	45.00	67.98	74.77
.3415	37.80	42.00	45.00	67.98	74.77
.3420	37.80	42.00	45.00	67.98	74.77
.3425	37.80	42.00	45.00	67.98	74.77
.3426	47.00	----	----	----	----
.3430	37.80	42.00	45.00	67.98	74.77
.3435	37.80	42.00	45.00	67.98	74.77
.3439	47.00	----	----	----	----
.3440	37.80	42.00	45.00	67.98	74.77
.3441	47.00	----	----	----	----
.3445	37.80	42.00	45.00	67.98	74.77
.3450	37.80	42.00	45.00	67.98	74.77
.3453	47.00	----	----	----	----
.3455	37.80	42.00	45.00	67.98	74.77
.3460	37.80	42.00	45.00	67.98	74.77
.3465	37.80	42.00	45.00	67.98	74.77
.3470	37.80	42.00	45.00	67.98	74.77
.3475	37.80	42.00	45.00	67.98	74.77
.3476	47.00	----	----	----	----
.3485	37.80	42.00	45.00	67.98	74.77
.3490	37.80	42.00	45.00	67.98	74.77
.3494	47.00	----	----	----	----
.3495	37.80	42.00	45.00	67.98	74.77
.3500	37.80	42.00	45.00	67.98	74.77
.3505	37.80	42.00	45.00	67.98	74.77
.3510	37.80	42.00	45.00	67.98	74.77
.3515	37.80	42.00	45.00	67.98	74.77
.3520	37.80	42.00	45.00	67.98	74.77
.3525	37.80	42.00	45.00	67.98	74.77
.3530	37.80	42.00	45.00	67.98	74.77
.3535	37.80	42.00	45.00	67.98	74.77
.3540	37.80	42.00	45.00	67.98	74.77
.3545	37.80	42.00	45.00	67.98	74.77
.3550	37.80	42.00	45.00	67.98	74.77
.3555	37.80	42.00	45.00	67.98	74.77
.3560	37.80	42.00	45.00	67.98	74.77
.3565	37.80	42.00	45.00	67.98	74.77
.3570	37.80	42.00	45.00	67.98	74.77
.3575	37.80	42.00	45.00	67.98	74.77
.3585	37.80	42.00	45.00	67.98	74.77
.3590	37.80	42.00	45.00	67.98	74.77
.3595	37.80	42.00	45.00	67.98	74.77
.3600	37.80	42.00	45.00	67.98	74.77
.3605	37.80	42.00	45.00	67.98	74.77
.3610	37.80	42.00	45.00	67.98	74.77
.3615	37.80	42.00	45.00	67.98	74.77
.3620	37.80	42.00	45.00	67.98	74.77
.3625	37.80	42.00	45.00	67.98	74.77
.3630	37.80	42.00	45.00	67.98	74.77
.3635	37.80	42.00	45.00	67.98	74.77
.3640	37.80	42.00	45.00	67.98	74.77
.3645	37.80	42.00	45.00	67.98	74.77
.3650	37.80	42.00	45.00	67.98	74.77
.3655	37.80	42.00	45.00	67.98	74.77
.3660	37.80	42.00	45.00	67.98	74.77
.3665	37.80	42.00	45.00	67.98	74.77
.3670	37.80	42.00	45.00	67.98	74.77
.3675	37.80	42.00	45.00	67.98	74.77
.3685	37.80	42.00	45.00	67.98	74.77

Note: Tolerance, Flute Length, Overall Length, and Shank Diameter are comparable to the closest standard size. See pages 4-9.

Chucking Reamers - Straight Shank - H.S. & Cobalt

Intermediate Decimal Sizes

List No. **LV533**: High Speed, Straight Flute

List No. **LV535**: High Speed, Right Hand Spiral, Right Hand Cut

List No. **LV535L**: High Speed, Left Hand Spiral, Right Hand Cut

List No. **1533**: Cobalt, Straight Flute

List No. **1535**: Cobalt, Right Hand Spiral, Right Hand Cut



Size	Price Each				
	LV533 Straight Flute	LV535 RH Spiral	LV535L LH Sp. RH Cut	1533 Cobalt Str. Fit.	1535 Cobalt RH Sp.
.3690	37.80	42.00	45.00	67.98	74.77
.3695	37.80	42.00	45.00	67.98	74.77
.3700	37.80	42.00	45.00	67.98	74.77
.3705	37.80	42.00	45.00	67.98	74.77
.3709	47.00	----	----	----	----
.3710	37.80	42.00	45.00	67.98	74.77
.3715	37.80	42.00	45.00	67.98	74.77
.3720	37.80	42.00	45.00	67.98	74.77
.3725	37.80	42.00	45.00	67.98	74.77
.3730	37.80	42.00	45.00	67.98	74.77
.3735	37.80	42.00	45.00	67.98	74.77
.3738	47.00	----	----	----	----
.3740	22.70	26.00	28.50	38.00	39.00
.3745	37.80	42.00	45.00	67.98	74.77
.3747	47.00	----	----	----	----
.3753	47.00	----	----	----	----
.3755	37.80	42.00	45.00	69.94	76.93
.3760	22.70	26.00	28.50	38.00	39.00
.3765	37.80	42.00	45.00	69.94	76.93
.3775	37.80	42.00	45.00	69.94	76.93
.3780	37.80	42.00	45.00	69.94	76.93
.3785	37.80	42.00	45.00	69.94	76.93
.3790	37.80	42.00	45.00	69.94	76.93
.3795	37.80	42.00	45.00	69.94	76.93
.3800	37.80	42.00	45.00	69.94	76.93
.3805	37.80	42.00	45.00	69.94	76.93
.3810	37.80	42.00	45.00	69.94	76.93
.3815	37.80	42.00	45.00	69.94	76.93
.3820	37.80	42.00	45.00	69.94	76.93
.3825	37.80	42.00	45.00	69.94	76.93
.3830	37.80	42.00	45.00	69.94	76.93
.3835	37.80	42.00	45.00	69.94	76.93
.3840	37.80	42.00	45.00	69.94	76.93
.3845	37.80	42.00	45.00	69.94	76.93
.3850	37.80	42.00	45.00	69.94	76.93
.3855	37.80	42.00	45.00	69.94	76.93
.3865	37.80	42.00	45.00	69.94	76.93
.3870	37.80	42.00	45.00	69.94	76.93
.3875	37.80	42.00	45.00	69.94	76.93
.3880	37.80	42.00	45.00	69.94	76.93
.3885	37.80	42.00	45.00	69.94	76.93
.3890	37.80	42.00	45.00	69.94	76.93
.3895	37.80	42.00	45.00	69.94	76.93
.3900	37.80	42.00	45.00	69.94	76.93
.3905	37.80	42.00	45.00	69.94	76.93
.3910	38.70	41.50	45.00	69.94	76.93
.3915	38.70	41.50	45.00	69.94	76.93
.3920	38.70	41.50	45.00	69.94	76.93
.3925	38.70	41.50	45.00	69.94	76.93
.3930	38.70	41.50	45.00	69.94	76.93
.3935	38.70	41.50	45.00	69.94	76.93
.3940	38.70	41.50	45.00	69.94	76.93
.3945	38.70	41.50	45.00	69.94	76.93
.3947	29.44	----	----	----	----
.3950	38.70	41.50	45.00	69.94	76.93
.3955	38.70	41.50	45.00	69.94	76.93
.3960	38.70	41.50	45.00	69.94	76.93
.3965	38.70	41.50	45.00	69.94	76.93
.3975	38.70	41.50	45.00	69.94	76.93

Size	Price Each				
	LV533 Straight Flute	LV535 RH Spiral	LV535L LH Sp. RH Cut	1533 Cobalt Str. Fit.	1535 Cobalt RH Sp.
.3980	38.70	41.50	45.00	69.94	76.93
.3985	38.70	41.50	45.00	69.94	76.93
.3990	38.70	41.50	45.00	69.94	76.93
.3995	38.70	41.50	45.00	69.94	76.93
.4000	38.70	41.50	45.00	69.94	76.93
.4005	38.70	41.50	45.00	69.94	76.93
.4010	38.70	41.50	45.00	69.94	76.93
.4015	38.70	41.50	45.00	69.94	76.93
.4020	38.70	41.50	45.00	69.94	76.93
.4025	38.70	41.50	45.00	69.94	76.93
.4030	38.70	41.50	45.00	69.94	76.93
.4035	38.70	41.50	45.00	69.94	76.93
.4045	38.70	41.50	45.00	69.94	76.93
.4050	38.70	41.50	45.00	69.94	76.93
.4055	38.70	41.50	45.00	69.94	76.93
.4060	38.70	41.50	45.00	69.94	76.93
.4065	38.70	41.50	45.00	69.94	76.93
.4070	38.70	41.50	45.00	69.94	76.93
.4075	38.70	41.50	45.00	69.94	76.93
.4080	38.70	41.50	45.00	69.94	76.93
.4085	38.70	41.50	45.00	69.94	76.93
.4090	38.70	41.50	45.00	69.94	76.93
.4095	38.70	41.50	45.00	69.94	76.93
.4100	38.70	41.50	45.00	69.94	76.93
.4105	38.70	41.50	45.00	69.94	76.93
.4110	38.70	41.50	45.00	69.94	76.93
.4115	38.70	41.50	45.00	69.94	76.93
.4120	38.70	41.50	45.00	69.94	76.93
.4125	38.70	41.50	45.00	69.94	76.93
.4135	38.70	41.50	45.00	69.94	76.93
.4140	38.70	41.50	45.00	69.94	76.93
.4145	38.70	41.50	45.00	69.94	76.93
.4150	38.70	41.50	45.00	69.94	76.93
.4155	38.70	41.50	45.00	69.94	76.93
.4160	38.70	41.50	45.00	69.94	76.93
.4165	38.70	41.50	45.00	69.94	76.93
.4170	38.70	41.50	45.00	69.94	76.93
.4175	38.70	41.50	45.00	69.94	76.93
.4180	38.70	41.50	45.00	69.94	76.93
.4185	38.70	41.50	45.00	69.94	76.93
.4190	38.70	41.50	45.00	69.94	76.93
.4195	38.70	41.50	45.00	69.94	76.93
.4200	38.70	41.50	45.00	69.94	76.93
.4205	38.70	41.50	45.00	69.94	76.93
.4210	38.70	41.50	45.00	69.94	76.93
.4215	38.70	41.50	45.00	69.94	76.93
.4220	38.70	41.50	45.00	69.94	76.93
.4225	38.70	41.50	45.00	69.94	76.93
.4230	38.70	41.50	45.00	69.94	76.93
.4232	49.00	----	----	----	76.93
.4235	38.70	41.50	45.00	69.94	76.93
.4240	38.70	41.50	45.00	69.94	76.93
.4245	38.70	41.50	45.00	69.94	76.93
.4250	38.70	41.50	45.00	69.94	76.93
.4255	38.70	41.50	45.00	69.94	76.93
.4260	38.70	41.50	45.00	69.94	76.93
.4265	38.70	41.50	45.00	69.94	76.93
.4270	38.70	41.50	45.00	69.94	76.93
.4275	38.70	41.50	45.00	69.94	76.93

Note: Tolerance, Flute Length, Overall Length, and Shank Diameter are comparable to the closest standard size. See pages 4-9.

Chucking Reamers - Straight Shank - H. S. & Cobalt

Intermediate Decimal Sizes

List No. **LV533**: High Speed, Straight Flute

List No. **LV535**: High Speed, Right Hand Spiral, Right Hand Cut

List No. **LV535L**: High Speed, Left Hand Spiral, Right Hand Cut

List No. **1533**: Cobalt, Straight Flute

List No. **1535**: Cobalt, Right Hand Spiral, Right Hand Cut



Size	Price Each				
	LV533 Straight Flute	LV535 RH Spiral	LV535L LH Sp. RH Cut	1533 Cobalt Str. Fit.	1535 Cobalt RH Sp.
.4280	38.70	41.50	45.00	69.94	76.93
.4285	38.70	41.50	45.00	69.94	76.93
.4290	38.70	41.50	45.00	69.94	76.93
.4295	38.70	41.50	45.00	69.94	76.93
.4300	38.70	41.50	45.00	69.94	76.93
.4305	38.70	41.50	45.00	69.94	76.93
.4310	38.70	41.50	45.00	69.94	76.93
.4315	38.70	41.50	45.00	69.94	76.93
.4320	38.70	41.50	45.00	69.94	76.93
.4325	38.70	41.50	45.00	69.94	76.93
.4330	38.70	41.50	45.00	69.94	76.93
.4335	38.70	41.50	45.00	69.94	76.93
.4336	49.00	----	----	----	----
.4340	38.70	41.50	45.00	69.94	76.93
.4345	38.70	41.50	45.00	69.94	76.93
.4350	38.70	41.50	45.00	69.94	76.93
.4355	38.70	41.50	45.00	69.94	76.93
.4357	49.00	----	----	----	----
.4360	38.70	41.50	45.00	69.94	76.93
.4365	26.95	29.70	34.00	48.00	49.50
.4370	38.70	41.50	45.00	78.75	86.62
.4378	49.00	----	----	----	----
.4380	41.00	45.00	48.00	78.75	86.62
.4385	26.95	29.70	34.00	48.00	49.50
.4390	41.00	45.00	48.00	78.75	86.62
.4395	41.00	45.00	48.00	78.75	86.82
.4400	41.00	45.00	48.00	78.75	86.62
.4405	41.00	45.00	48.00	78.75	86.62
.4410	41.00	45.00	48.00	78.75	86.62
.4415	41.00	45.00	48.00	78.75	86.62
.4420	41.00	45.00	48.00	78.75	86.62
.4425	41.00	45.00	48.00	78.75	86.62
.4430	41.00	45.00	48.00	78.75	86.62
.4435	41.00	45.00	48.00	78.75	86.62
.4440	41.00	45.00	48.00	78.75	86.62
.4445	41.00	45.00	48.00	78.75	86.62
.4450	41.00	45.00	48.00	78.75	86.82
.4455	41.00	45.00	48.00	78.75	86.62
.4460	41.00	45.00	48.00	78.75	86.62
.4465	41.00	45.00	48.00	78.75	86.62
.4470	41.00	45.00	48.00	78.75	86.62
.4475	41.00	45.00	48.00	78.75	86.62
.4478	55.00	----	----	----	----
.4480	41.00	45.00	48.00	78.75	86.62
.4485	41.00	45.00	48.00	78.75	86.62
.4490	41.00	45.00	48.00	78.75	86.62
.4495	41.00	45.00	48.00	78.75	86.62
.4500	41.00	45.00	48.00	78.75	86.62
.4505	41.00	45.00	48.00	78.75	86.82
.4510	41.00	45.00	48.00	78.75	86.62
.4515	41.00	45.00	48.00	78.75	86.62
.4520	41.00	45.00	48.00	78.75	86.62
.4525	41.00	45.00	48.00	78.75	86.62
.4526	55.00	----	----	----	----
.4530	41.00	45.00	48.00	78.75	86.62
.4535	41.00	45.00	48.00	78.75	86.62
.4540	41.00	45.00	48.00	78.75	86.62
.4545	41.00	45.00	48.00	78.75	86.62
.4550	41.00	45.00	48.00	78.75	86.82

Size	Price Each				
	LV533 Straight Flute	LV535 RH Spiral	LV535L LH Sp. RH Cut	1533 Cobalt Str. Fit.	1535 Cobalt RH Sp.
.4555	41.00	45.00	48.00	78.75	86.62
.4560	41.00	45.00	48.00	78.75	86.62
.4565	41.00	45.00	48.00	78.75	86.62
.4570	41.00	45.00	48.00	78.75	86.62
.4575	41.00	45.00	48.00	78.75	86.62
.4580	41.00	45.00	48.00	78.75	86.62
.4585	41.00	45.00	48.00	78.75	86.62
.4590	41.00	45.00	48.00	78.75	86.62
.4595	41.00	45.00	48.00	78.75	86.62
.4600	41.00	45.00	48.00	78.75	86.62
.4605	41.00	45.00	48.00	78.75	86.62
.4610	41.00	45.00	48.00	78.75	86.62
.4615	41.00	45.00	48.00	78.75	86.62
.4620	41.00	45.00	48.00	78.75	86.62
.4625	41.00	45.00	48.00	78.75	86.62
.4630	41.00	45.00	48.00	78.75	86.82
.4635	41.00	45.00	48.00	78.75	86.62
.4640	41.00	45.00	48.00	78.75	86.62
.4645	41.00	45.00	48.00	78.75	86.62
.4650	41.00	45.00	48.00	78.75	86.62
.4655	41.00	45.00	48.00	78.75	86.62
.4660	41.00	45.00	48.00	78.75	86.62
.4665	41.00	45.00	48.00	78.75	86.62
.4670	41.00	45.00	48.00	78.75	86.62
.4675	41.00	45.00	48.00	78.75	86.62
.4680	41.00	45.00	48.00	78.75	86.62
.4685	41.00	45.00	48.00	78.75	86.62
.4690	41.00	45.00	48.00	78.75	86.62
.4695	41.00	45.00	48.00	78.75	86.82
.4700	41.00	45.00	48.00	78.75	86.62
.4705	41.00	45.00	48.00	78.75	86.62
.4710	41.00	45.00	48.00	78.75	86.62
.4714	55.00	----	----	----	----
.4715	41.00	45.00	48.00	78.75	86.62
.4719	55.00	----	----	----	----
.4720	41.00	45.00	48.00	78.75	86.62
.4725	41.00	45.00	48.00	78.75	86.62
.4730	41.00	45.00	48.00	78.75	86.62
.4735	41.00	45.00	48.00	78.75	86.62
.4740	41.00	45.00	48.00	78.75	86.62
.4745	41.00	45.00	48.00	78.75	86.62
.4750	41.00	45.00	48.00	78.75	86.62
.4755	41.00	45.00	48.00	78.75	86.62
.4760	41.00	45.00	48.00	78.75	86.82
.4765	41.00	45.00	48.00	78.75	86.62
.4770	41.00	45.00	48.00	78.75	86.62
.4775	41.00	45.00	48.00	78.75	86.62
.4780	41.00	45.00	48.00	78.75	86.62
.4785	41.00	45.00	48.00	78.75	86.62
.4790	41.00	45.00	48.00	78.75	86.62
.4795	41.00	45.00	48.00	78.75	86.62
.4800	41.00	45.00	48.00	78.75	86.62
.4805	41.00	45.00	48.00	78.75	86.62
.4810	41.00	45.00	48.00	78.75	86.62
.4815	41.00	45.00	48.00	78.75	86.62
.4820	41.00	45.00	48.00	78.75	86.62
.4825	41.00	45.00	48.00	78.75	86.82
.4830	41.00	45.00	48.00	78.75	86.62
.4835	41.00	45.00	48.00	78.75	86.62

Note: Tolerance, Flute Length, Overall Length, and Shank Diameter are comparable to the closest standard size. See pages 4-9.

Chucking Reamers - Straight Shank - H. S. & Cobalt

Intermediate Decimal Sizes

- List No. **LV533**: High Speed, Straight Flute
- List No. **LV535**: High Speed, Right Hand Spiral, Right Hand Cut
- List No. **LV535L**: High Speed, Left Hand Spiral, Right Hand Cut
- List No. **1533**: Cobalt, Straight Flute
- List No. **1535**: Cobalt, Right Hand Spiral, Right Hand Cut



Decimal Chucking Reamers

Size	Price Each				
	LV533 Straight Flute	LV535 RH Spiral	LV535L LH Sp. RH Cut	1533 Cobalt Str. Fit.	1535 Cobalt RH Sp.
.4840	41.00	45.00	48.00	78.75	86.62
.4845	41.00	45.00	48.00	78.75	86.62
.4850	41.00	45.00	48.00	78.75	86.62
.4855	41.00	45.00	48.00	78.75	86.62
.4860	41.00	45.00	48.00	78.75	86.62
.4865	41.00	45.00	48.00	78.75	86.62
.4870	41.00	45.00	48.00	78.75	86.62
.4875	41.00	45.00	48.00	78.75	86.62
.4880	41.00	45.00	48.00	78.75	86.62
.4885	41.00	45.00	48.00	78.75	86.62
.4890	41.00	45.00	48.00	78.75	86.62
.4895	41.00	45.00	48.00	78.75	86.62
.4900	41.00	45.00	48.00	78.75	86.62
.4905	41.00	45.00	48.00	78.75	86.62
.4910	41.00	45.00	48.00	78.75	86.62
.4915	41.00	45.00	48.00	78.75	86.62
.4920	41.00	45.00	48.00	78.75	86.62
.4922	55.00	----	----	----	----
.4925	41.00	45.00	48.00	78.75	86.62
.4930	41.00	45.00	48.00	78.75	86.62
.4935	41.00	45.00	48.00	78.75	86.62
.4937	55.00	----	----	----	----
.4940	41.00	45.00	48.00	78.75	86.62
.4945	41.00	45.00	48.00	78.75	86.62
.4950	41.00	45.00	48.00	78.75	86.62
.4955	41.00	45.00	48.00	78.75	86.62
.4960	41.00	45.00	48.00	78.75	86.62
.4965	41.00	45.00	48.00	78.75	86.62
.4970	41.00	45.00	48.00	78.75	86.62
.4975	41.00	45.00	48.00	78.75	86.62
.4980	41.00	45.00	48.00	78.75	86.62
.4985	41.00	45.00	48.00	78.75	86.62
.4990	27.80	32.30	36.80	54.50	56.00
.4995	41.00	45.00	48.00	78.75	86.62
.4997	55.00	----	----	----	----
.5005	64.00	70.40	75.30	79.00	86.62
.5010	27.80	32.30	36.80	54.50	56.00
.5015	64.00	70.40	75.30	79.00	89.62
.5020	64.00	70.40	75.30	79.00	89.62
.5025	64.00	70.40	75.30	79.00	89.62
.5030	64.00	70.40	75.30	79.00	89.62
.5035	64.00	70.40	75.30	79.00	89.62
.5040	64.00	70.40	75.30	79.00	89.62
.5045	64.00	70.40	75.30	79.00	89.62
.5050	64.00	70.40	75.30	79.00	89.62
.5055	64.00	70.40	75.30	79.00	89.62
.5060	64.00	70.40	75.30	79.00	89.62
.5065	64.00	70.40	75.30	79.00	89.62
.5070	64.00	70.40	75.30	79.00	89.62
.5075	64.00	70.40	75.30	79.00	89.62
.5080	64.00	70.40	75.30	79.00	89.62
.5085	64.00	70.40	75.30	79.00	89.62
.5090	64.00	70.40	75.30	79.00	89.62
.5095	64.00	70.40	75.30	79.00	89.62
.5100	64.00	70.40	75.30	79.00	89.62
.5105	64.00	70.40	75.30	79.00	89.62
.5110	64.00	70.40	75.30	79.00	89.62
.5115	64.00	70.40	75.30	79.00	89.62
.5120	64.00	70.40	75.30	79.00	89.62

Size	Price Each				
	LV533 Straight Flute	LV535 RH Spiral	LV535L LH Sp. RH Cut	1533 Cobalt Str. Fit.	1535 Cobalt RH Sp.
.5125	64.00	70.40	75.30	79.00	89.62
.5130	64.00	70.40	75.30	79.00	89.62
.5135	64.00	70.40	75.30	79.00	89.62
.5140	64.00	70.40	75.30	79.00	89.62
.5145	64.00	70.40	75.30	79.00	89.62
.5150	64.00	70.40	75.30	79.00	89.62
.5155	64.00	70.40	75.30	79.00	89.62
.5160	64.00	70.40	75.30	79.00	89.62
.5165	64.00	70.40	75.30	79.00	89.62
.5170	64.00	70.40	75.30	79.00	89.62
.5175	64.00	70.40	75.30	79.00	89.62
.5180	64.00	70.40	75.30	79.00	89.62
.5185	64.00	70.40	75.30	79.00	89.62
.5190	64.00	70.40	75.30	79.00	89.62
.5195	64.00	70.40	75.30	79.00	89.62
.5198	69.00	----	----	----	----
.5200	64.00	70.40	75.30	79.00	89.62
.5205	64.00	70.40	75.30	79.00	89.62
.5210	64.00	70.40	75.30	79.00	89.62
.5215	64.00	70.40	75.30	79.00	89.62
.5220	64.00	70.40	75.30	79.00	89.62
.5225	64.00	70.40	75.30	79.00	89.62
.5230	64.00	70.40	75.30	79.00	89.62
.5235	64.00	70.40	75.30	79.00	89.62
.5240	64.00	70.40	75.30	79.00	89.62
.5245	64.00	70.40	75.30	79.00	89.62
.5250	64.00	70.40	75.30	79.00	89.62
.5255	64.00	70.40	75.30	79.00	89.62
.5260	64.00	70.40	75.30	79.00	89.62
.5265	64.00	70.40	75.30	79.00	89.62
.5270	64.00	70.40	75.30	79.00	89.62
.5275	64.00	70.40	75.30	79.00	89.62
.5280	64.00	70.40	75.30	79.00	89.62
.5285	64.00	70.40	75.30	79.00	89.62
.5290	64.00	70.40	75.30	79.00	89.62
.5295	64.00	70.40	75.30	79.00	89.62
.5300	64.00	70.40	75.30	79.00	89.62
.5305	64.00	70.40	75.30	79.00	89.62
.5310	64.00	70.40	75.30	79.00	89.62
.5315	36.00	44.00	47.00	----	----
.5320	64.00	70.40	75.30	79.00	89.62
.5325	64.00	70.40	75.30	79.00	89.62
.5330	64.00	70.40	75.30	79.00	89.62
.5335	64.00	70.40	75.30	79.00	89.62
.5340	64.00	70.40	75.30	79.00	89.62
.5345	64.00	70.40	75.30	79.00	89.62
.5350	64.00	70.40	75.30	79.00	89.62
.5355	64.00	70.40	75.30	79.00	89.62
.5360	64.00	70.40	75.30	79.00	89.62
.5365	64.00	70.40	75.30	79.00	89.62
.5370	64.00	70.40	75.30	79.00	89.62
.5375	64.00	70.40	75.30	79.00	89.62
.5380	64.00	70.40	75.30	79.00	89.62
.5385	64.00	70.40	75.30	79.00	89.62
.5390	64.00	70.40	75.30	79.00	89.62
.5395	64.00	70.40	75.30	79.00	89.62
.5400	64.00	70.40	75.30	79.00	89.62
.5405	64.00	70.40	75.30	79.00	89.62
.5410	64.00	70.40	75.30	79.00	89.62

Note: Tolerance, Flute Length, Overall Length, and Shank Diameter are comparable to the closest standard size. See pages 4-9.

Chucking Reamers - Straight Shank - H.S. & Cobalt

Intermediate Decimal Sizes

List No. **LV533**: High Speed, Straight Flute

List No. **LV535**: High Speed, Right Hand Spiral, Right Hand Cut

List No. **LV535L**: High Speed, Left Hand Spiral, Right Hand Cut

List No. **1533**: Cobalt, Straight Flute

List No. **1535**: Cobalt, Right Hand Spiral, Right Hand Cut



Size	Price Each				
	LV533 Straight Flute	LV535 RH Spiral	LV535L LH Sp. RH Cut	1533 Cobalt Str. Fit.	1535 Cobalt RH Sp.
.5415	64.00	70.40	75.30	79.00	89.62
.5420	64.00	70.40	75.30	79.00	89.62
.5425	64.00	70.40	75.30	79.00	89.62
.5430	64.00	70.40	75.30	79.00	89.62
.5435	64.00	70.40	75.30	79.00	89.62
.5440	64.00	70.40	75.30	79.00	89.62
.5445	64.00	70.40	75.30	79.00	89.62
.5448	69.00	----	----	----	----
.5450	64.00	70.40	75.30	79.00	89.62
.5455	64.00	70.40	75.30	79.00	89.62
.5460	64.00	70.40	75.30	79.00	89.62
.5465	64.00	70.40	75.30	79.00	89.62
.5470	64.00	70.40	75.30	79.00	89.62
.5475	64.00	70.40	75.30	79.00	89.62
.5480	64.00	70.40	75.30	79.00	89.62
.5485	64.00	70.40	75.30	79.00	89.62
.5490	64.00	70.40	75.30	79.00	89.62
.5495	64.00	70.40	75.30	79.00	89.62
.5500	64.00	70.40	75.30	79.00	89.62
.5505	64.00	70.40	75.30	79.00	89.62
.5510	64.00	70.40	75.30	79.00	89.62
.5515	64.00	70.40	75.30	79.00	89.62
.5520	64.00	70.40	75.30	79.00	89.62
.5525	64.00	70.40	75.30	79.00	89.62
.5530	64.00	70.40	75.30	79.00	89.62
.5535	64.00	70.40	75.30	79.00	89.62
.5540	64.00	70.40	75.30	79.00	89.62
.5545	64.00	70.40	75.30	79.00	89.62
.5550	64.00	70.40	75.30	79.00	89.62
.5555	64.00	70.40	75.30	79.00	89.62
.5560	64.00	70.40	75.30	79.00	89.62
.5565	64.00	70.40	75.30	79.00	89.62
.5570	64.00	70.40	75.30	79.00	89.62
.5575	64.00	70.40	75.30	79.00	89.62
.5580	64.00	70.40	75.30	79.00	89.62
.5585	64.00	70.40	75.30	79.00	89.62
.5590	64.00	70.40	75.30	79.00	89.62
.5595	64.00	70.40	75.30	79.00	89.62
.5600	64.00	70.40	75.30	79.00	89.62
.5605	64.00	70.40	75.30	79.00	89.62
.5610	64.00	70.40	75.30	79.00	89.62
.5615	36.00	44.00	49.00	72.38	77.00
.5620	64.00	70.40	75.30	79.00	89.62
.5630	64.00	70.40	75.30	79.00	89.62
.5635	36.00	44.00	49.00	72.38	77.00
.5640	64.00	70.40	75.30	79.00	89.62
.5645	64.00	70.40	75.30	79.00	89.62
.5650	64.00	70.40	75.30	79.00	89.62
.5655	64.00	70.40	75.30	79.00	89.62
.5660	64.00	70.40	75.30	79.00	89.62
.5665	64.00	70.40	75.30	79.00	89.62
.5670	64.00	70.40	75.30	79.00	89.62
.5675	64.00	70.40	75.30	79.00	89.62
.5680	64.00	70.40	75.30	79.00	89.62
.5685	64.00	70.40	75.30	79.00	89.62
.5690	64.00	70.40	75.30	79.00	89.62
.5695	64.00	70.40	75.30	79.00	89.62
.5700	64.00	70.40	75.30	79.00	89.62
.5705	64.00	70.40	75.30	79.00	89.62

Size	Price Each				
	LV533 Straight Flute	LV535 RH Spiral	LV535L LH Sp. RH Cut	1533 Cobalt Str. Fit.	1535 Cobalt RH Sp.
.5710	64.00	70.40	75.30	79.00	89.62
.5715	64.00	70.40	75.30	79.00	89.62
.5720	64.00	70.40	75.30	79.00	89.62
.5725	64.00	70.40	75.30	79.00	89.62
.5730	64.00	70.40	75.30	79.00	89.62
.5735	64.00	70.40	75.30	79.00	89.62
.5740	64.00	70.40	75.30	79.00	89.62
.5745	64.00	70.40	75.30	79.00	89.62
.5750	64.00	70.40	75.30	79.00	89.62
.5755	64.00	70.40	75.30	79.00	89.62
.5760	64.00	70.40	75.30	79.00	89.62
.5765	64.00	70.40	75.30	79.00	89.62
.5770	64.00	70.40	75.30	79.00	89.62
.5775	64.00	70.40	75.30	79.00	89.62
.5780	64.00	70.40	75.30	79.00	89.62
.5785	64.00	70.40	75.30	79.00	89.62
.5790	64.00	70.40	75.30	79.00	89.62
.5795	64.00	70.40	75.30	79.00	89.62
.5800	64.00	70.40	75.30	79.00	89.62
.5805	64.00	70.40	75.30	79.00	89.62
.5810	64.00	70.40	75.30	79.00	89.62
.5815	64.00	70.40	75.30	79.00	89.62
.5820	64.00	70.40	75.30	79.00	89.62
.5825	64.00	70.40	75.30	79.00	89.62
.5830	64.00	70.40	75.30	79.00	89.62
.5835	64.00	70.40	75.30	79.00	89.62
.5840	64.00	70.40	75.30	79.00	89.62
.5845	64.00	70.40	75.30	79.00	89.62
.5850	64.00	70.40	75.30	79.00	89.62
.5855	64.00	70.40	75.30	79.00	89.62
.5860	64.00	70.40	75.30	79.00	89.62
.5865	64.00	70.40	75.30	79.00	89.62
.5870	64.00	70.40	75.30	79.00	89.62
.5875	64.00	70.40	75.30	79.00	89.62
.5880	64.00	70.40	75.30	79.00	89.62
.5885	64.00	70.40	75.30	79.00	89.62
.5890	64.00	70.40	75.30	79.00	89.62
.5895	64.00	70.40	75.30	79.00	89.62
.5900	64.00	70.40	75.30	79.00	89.62
.5905	64.00	70.40	75.30	79.00	89.62
.5910	64.00	70.40	75.30	79.00	89.62
.5915	64.00	70.40	75.30	79.00	89.62
.5920	64.00	70.40	75.30	79.00	89.62
.5925	64.00	70.40	75.30	79.00	89.62
.5930	64.00	70.40	75.30	79.00	89.62
.5935	64.00	70.40	75.30	79.00	89.62
.5940	64.00	70.40	75.30	79.00	89.62
.5945	64.00	70.40	75.30	79.00	89.62
.5950	64.00	70.40	75.30	79.00	89.62
.5955	64.00	70.40	75.30	79.00	89.62
.5960	64.00	70.40	75.30	79.00	89.62
.5965	64.00	70.40	75.30	79.00	89.62
.5970	64.00	70.40	75.30	79.00	89.62
.5975	64.00	70.40	75.30	79.00	89.62
.5980	64.00	70.40	75.30	79.00	89.62
.5985	64.00	70.40	75.30	79.00	89.62
.5990	64.00	70.40	75.30	79.00	89.62
.5995	64.00	70.40	75.30	79.00	89.62
.6000	64.00	70.40	75.30	79.00	89.62

Note: Tolerance, Flute Length, Overall Length, and Shank Diameter are comparable to the closest standard size. See pages 4-9.

Chucking Reamers - Straight Shank - H.S. & Cobalt

Intermediate Decimal Sizes

- List No. **LV533**: High Speed, Straight Flute
- List No. **LV535**: High Speed, Right Hand Spiral, Right Hand Cut
- List No. **LV535L**: High Speed, Left Hand Spiral, Right Hand Cut
- List No. **1533**: Cobalt, Straight Flute
- List No. **1535**: Cobalt, Right Hand Spiral, Right Hand Cut

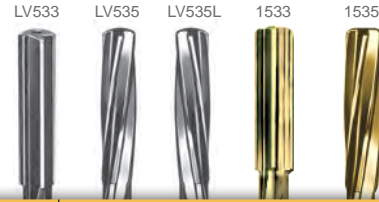

Size	Price Each				
	LV533 Straight Flute	LV535 RH Spiral	LV535L LH Sp. RH Cut	1533 Cobalt Str. Fit.	1535 Cobalt RH Sp.
.6005	64.00	70.40	75.30	79.00	89.62
.6010	64.00	70.40	75.30	79.00	89.62
.6015	64.00	70.40	75.30	79.00	89.62
.6020	64.00	70.40	75.30	79.00	89.62
.6025	64.00	70.40	75.30	79.00	89.62
.6030	64.00	70.40	75.30	79.00	89.62
.6035	64.00	70.40	75.30	79.00	89.62
.6040	64.00	70.40	75.30	79.00	89.62
.6045	64.00	70.40	75.30	79.00	89.62
.6050	64.00	70.40	75.30	79.00	89.62
.6055	64.00	70.40	75.30	79.00	89.62
.6060	64.00	70.40	75.30	79.00	89.62
.6065	64.00	70.40	75.30	79.00	89.62
.6070	64.00	70.40	75.30	79.00	89.62
.6075	64.00	70.40	75.30	79.00	89.62
.6080	64.00	70.40	75.30	79.00	89.62
.6085	64.00	70.40	75.30	79.00	89.62
.6090	64.00	70.40	75.30	79.00	89.62
.6095	64.00	70.40	75.30	79.00	89.62
.6100	64.00	70.40	75.30	79.00	89.62
.6105	64.00	70.40	75.30	79.00	89.62
.6110	64.00	70.40	75.30	79.00	89.62
.6115	64.00	70.40	75.30	79.00	89.62
.6120	64.00	70.40	75.30	79.00	89.62
.6125	64.00	70.40	75.30	79.00	89.62
.6130	64.00	70.40	75.30	79.00	89.62
.6135	64.00	70.40	75.30	79.00	89.62
.6140	64.00	70.40	75.30	79.00	89.62
.6145	64.00	70.40	75.30	79.00	89.62
.6150	64.00	70.40	75.30	79.00	89.62
.6155	64.00	70.40	75.30	79.00	89.62
.6160	64.00	70.40	75.30	79.00	89.62
.6165	64.00	70.40	75.30	79.00	89.62
.6170	64.00	70.40	75.30	79.00	89.62
.6175	64.00	70.40	75.30	79.00	89.62
.6180	64.00	70.40	75.30	79.00	89.62
.6185	64.00	70.40	75.30	79.00	89.62
.6190	64.00	70.40	75.30	79.00	89.62
.6195	64.00	70.40	75.30	79.00	89.62
.6200	64.00	70.40	75.30	79.00	89.62
.6205	64.00	70.40	75.30	79.00	89.62
.6210	64.00	70.40	75.30	79.00	89.62
.6215	64.00	70.40	75.30	79.00	89.62
.6220	64.00	70.40	75.30	79.00	89.62
.6225	64.00	70.40	75.30	79.00	89.62
.6230	64.00	70.40	75.30	79.00	89.62
.6235	64.00	70.40	75.30	79.00	89.62
.6240	41.00	54.00	61.50	82.00	89.50
.6245	64.00	70.40	75.30	79.00	89.62
.6255	64.00	70.40	75.30	79.00	89.62
.6260	41.00	54.00	61.50	82.00	89.50
.6265	64.00	70.40	73.60	85.00	89.62
.6270	74.00	79.20	84.00	85.00	95.49
.6275	74.00	79.20	84.00	85.00	95.49
.6280	74.00	79.20	84.00	85.00	95.49
.6285	74.00	79.20	84.00	85.00	95.49
.6290	74.00	79.20	84.00	85.00	95.49
.6295	74.00	79.20	84.00	85.00	95.49
.6300	74.00	79.20	84.00	85.00	95.49

Size	Price Each				
	LV533 Straight Flute	LV535 RH Spiral	LV535L LH Sp. RH Cut	1533 Cobalt Str. Fit.	1535 Cobalt RH Sp.
.6304	77.00	----	----	----	----
.6305	74.00	79.20	84.00	85.00	95.49
.6310	74.00	79.20	84.00	85.00	95.49
.6315	74.00	79.20	84.00	85.00	95.49
.6320	74.00	79.20	84.00	85.00	95.49
.6325	74.00	79.20	84.00	85.00	95.49
.6330	74.00	79.20	84.00	85.00	95.49
.6335	74.00	79.20	84.00	85.00	95.49
.6340	74.00	79.20	84.00	85.00	95.49
.6345	74.00	79.20	84.00	99.00	110.00
.6350	74.00	79.20	84.00	99.00	110.00
.6355	74.00	79.20	84.00	99.00	110.00
.6360	74.00	79.20	84.00	99.00	110.00
.6365	74.00	79.20	84.00	99.00	110.00
.6370	74.00	79.20	84.00	99.00	110.00
.6375	74.00	79.20	84.00	99.00	110.00
.6380	74.00	79.20	84.00	99.00	110.00
.6385	74.00	79.20	84.00	99.00	110.00
.6390	74.00	79.20	84.00	99.00	110.00
.6395	74.00	79.20	84.00	99.00	110.00
.6400	74.00	79.20	84.00	99.00	110.00
.6405	74.00	79.20	84.00	99.00	110.00
.6410	74.00	79.20	84.00	99.00	110.00
.6415	74.00	79.20	84.00	99.00	110.00
.6420	74.00	79.20	84.00	99.00	110.00
.6425	74.00	79.20	84.00	99.00	110.00
.6430	74.00	79.20	84.00	99.00	110.00
.6435	74.00	79.20	84.00	99.00	110.00
.6440	74.00	79.20	84.00	99.00	110.00
.6445	74.00	79.20	84.00	99.00	110.00
.6450	74.00	79.20	84.00	99.00	110.00
.6455	74.00	79.20	84.00	99.00	110.00
.6460	74.00	79.20	84.00	99.00	110.00
.6465	74.00	79.20	84.00	99.00	110.00
.6470	74.00	79.20	84.00	99.00	110.00
.6475	74.00	79.20	84.00	99.00	110.00
.6480	74.00	79.20	84.00	99.00	110.00
.6485	74.00	79.20	84.00	99.00	110.00
.6490	74.00	79.20	84.00	99.00	110.00
.6495	74.00	79.20	84.00	99.00	110.00
.6500	74.00	79.20	84.00	99.00	110.00
.6505	74.00	79.20	84.00	99.00	110.00
.6510	74.00	79.20	84.00	99.00	110.00
.6515	74.00	79.20	84.00	99.00	110.00
.6520	74.00	79.20	84.00	99.00	110.00
.6525	74.00	79.20	84.00	99.00	110.00
.6530	74.00	79.20	84.00	99.00	110.00
.6535	74.00	79.20	84.00	99.00	110.00
.6540	74.00	79.20	84.00	99.00	110.00
.6545	74.00	79.20	84.00	99.00	110.00
.6550	74.00	79.20	84.00	99.00	110.00
.6555	74.00	79.20	84.00	99.00	110.00
.6560	74.00	79.20	84.00	99.00	110.00
.6565	74.00	79.20	84.00	99.00	110.00
.6570	74.00	79.20	84.00	99.00	110.00
.6575	74.00	79.20	84.00	99.00	110.00
.6580	74.00	79.20	84.00	99.00	110.00
.6585	74.00	79.20	84.00	99.00	110.00
.6590	74.00	79.20	84.00	99.00	110.00

Note: Tolerance, Flute Length, Overall Length, and Shank Diameter are comparable to the closest standard size. See pages 4-9.

Chucking Reamers - Straight Shank - H.S. & Cobalt

Intermediate Decimal Sizes

List No. **LV533**: High Speed, Straight Flute

List No. **LV535**: High Speed, Right Hand Spiral, Right Hand Cut

List No. **LV535L**: High Speed, Left Hand Spiral, Right Hand Cut

List No. **1533**: Cobalt, Straight Flute

List No. **1535**: Cobalt, Right Hand Spiral, Right Hand Cut



Size	Price Each				
	LV533 Straight Flute	LV535 RH Spiral	LV535L LH Sp. RH Cut	1533 Cobalt Str. Fit.	1535 Cobalt RH Sp.
.6595	74.00	79.20	84.00	99.00	110.00
.6600	74.00	79.20	84.00	99.00	110.00
.6605	74.00	79.20	84.00	99.00	110.00
.6610	74.00	79.20	84.00	99.00	110.00
.6615	74.00	79.20	84.00	99.00	110.00
.6620	74.00	79.20	84.00	99.00	110.00
.6625	74.00	79.20	84.00	99.00	110.00
.6630	74.00	79.20	84.00	99.00	110.00
.6635	74.00	79.20	84.00	99.00	110.00
.6640	74.00	79.20	84.00	99.00	110.00
.6645	74.00	79.20	84.00	99.00	110.00
.6650	74.00	79.20	84.00	99.00	110.00
.6655	74.00	79.20	84.00	99.00	110.00
.6660	74.00	79.20	84.00	99.00	110.00
.6665	74.00	79.20	84.00	99.00	110.00
.6670	74.00	79.20	84.00	99.00	110.00
.6675	74.00	79.20	84.00	99.00	110.00
.6680	74.00	79.20	84.00	99.00	110.00
.6685	74.00	79.20	84.00	99.00	110.00
.6690	74.00	79.20	84.00	99.00	110.00
.6695	74.00	79.20	84.00	99.00	110.00
.6700	74.00	79.20	84.00	99.00	110.00
.6705	74.00	79.20	84.00	99.00	110.00
.6710	74.00	79.20	84.00	99.00	110.00
.6715	74.00	79.20	84.00	99.00	110.00
.6720	74.00	79.20	84.00	99.00	110.00
.6725	74.00	79.20	84.00	99.00	110.00
.6730	74.00	79.20	84.00	99.00	110.00
.6735	74.00	79.20	84.00	99.00	110.00
.6740	74.00	79.20	84.00	99.00	110.00
.6745	74.00	79.20	84.00	99.00	110.00
.6750	74.00	79.20	84.00	99.00	110.00
.6755	74.00	79.20	84.00	99.00	110.00
.6760	74.00	79.20	84.00	99.00	110.00
.6765	74.00	79.20	84.00	99.00	110.00
.6770	74.00	79.20	84.00	99.00	110.00
.6775	74.00	79.20	84.00	99.00	110.00
.6780	74.00	79.20	84.00	99.00	110.00
.6785	74.00	79.20	84.00	99.00	110.00
.6790	74.00	79.20	84.00	99.00	110.00
.6795	74.00	79.20	84.00	99.00	110.00
.6800	74.00	79.20	84.00	99.00	110.00
.6805	74.00	79.20	84.00	99.00	110.00
.6810	74.00	79.20	84.00	99.00	110.00
.6815	74.00	79.20	84.00	99.00	110.00
.6820	74.00	79.20	84.00	99.00	110.00
.6825	74.00	79.20	84.00	99.00	110.00
.6830	74.00	79.20	84.00	99.00	110.00
.6835	74.00	79.20	84.00	99.00	110.00
.6840	74.00	79.20	84.00	99.00	110.00
.6845	74.00	79.20	84.00	99.00	110.00
.6850	74.00	79.20	84.00	99.00	110.00
.6855	74.00	79.20	84.00	99.00	110.00
.6860	74.00	79.20	84.00	99.00	110.00
.6865	46.50	61.00	66.00	88.00	94.00
.6870	81.00	86.00	90.00	99.00	110.00
.6880	81.00	83.50	90.00	102.00	118.00
.6885	49.55	61.00	66.00	88.00	94.00
.6890	48.54	63.00	66.00	---	---

Size	Price Each				
	LV533 Straight Flute	LV535 RH Spiral	LV535L LH Sp. RH Cut	1533 Cobalt Str. Fit.	1535 Cobalt RH Sp.
.6895	81.00	86.00	90.00	102.00	118.00
.6900	81.00	86.00	90.00	102.00	118.00
.6905	81.00	86.00	90.00	102.00	118.00
.6910	81.00	86.00	90.00	102.00	118.00
.6915	81.00	86.00	90.00	102.00	118.00
.6920	81.00	86.00	90.00	102.00	118.00
.6925	81.00	86.00	90.00	102.00	118.00
.6930	81.00	86.00	90.00	102.00	118.00
.6935	81.00	86.00	90.00	102.00	118.00
.6940	81.00	86.00	90.00	102.00	118.00
.6945	81.00	86.00	90.00	102.00	118.00
.6950	81.00	86.00	90.00	102.00	118.00
.6955	81.00	86.00	90.00	102.00	118.00
.6960	81.00	86.00	90.00	102.00	118.00
.6965	81.00	86.00	90.00	102.00	118.00
.6970	81.00	86.00	90.00	102.00	118.00
.6975	81.00	86.00	90.00	102.00	118.00
.6980	81.00	86.00	90.00	102.00	118.00
.6985	81.00	86.00	90.00	102.00	118.00
.6990	81.00	86.00	90.00	102.00	118.00
.6995	81.00	86.00	90.00	102.00	118.00
.7000	81.00	86.00	90.00	102.00	118.00
.7005	81.00	86.00	90.00	102.00	118.00
.7010	81.00	86.00	90.00	102.00	118.00
.7015	81.00	86.00	90.00	102.00	118.00
.7020	81.00	86.00	90.00	102.00	118.00
.7025	81.00	86.00	90.00	102.00	118.00
.7030	81.00	86.00	90.00	102.00	118.00
.7035	81.00	86.00	90.00	102.00	118.00
.7040	81.00	86.00	90.00	102.00	118.00
.7045	81.00	86.00	90.00	102.00	118.00
.7050	81.00	86.00	90.00	102.00	118.00
.7055	81.00	86.00	90.00	102.00	118.00
.7060	81.00	86.00	90.00	102.00	118.00
.7065	81.00	86.00	90.00	102.00	118.00
.7070	81.00	86.00	90.00	102.00	118.00
.7075	81.00	86.00	90.00	102.00	118.00
.7080	81.00	86.00	90.00	102.00	118.00
.7085	81.00	86.00	90.00	102.00	118.00
.7090	81.00	86.00	90.00	102.00	118.00
.7095	81.00	86.00	90.00	102.00	118.00
.7100	81.00	86.00	90.00	102.00	118.00
.7105	81.00	86.00	90.00	102.00	118.00
.7110	81.00	86.00	90.00	102.00	118.00
.7115	81.00	86.00	90.00	102.00	118.00
.7120	81.00	86.00	90.00	102.00	118.00
.7125	81.00	86.00	90.00	102.00	118.00
.7130	81.00	86.00	90.00	102.00	118.00
.7135	81.00	86.00	90.00	102.00	118.00
.7140	81.00	86.00	90.00	102.00	118.00
.7145	81.00	86.00	90.00	102.00	118.00
.7150	81.00	86.00	90.00	102.00	118.00
.7155	81.00	86.00	90.00	102.00	118.00
.7160	81.00	86.00	90.00	102.00	118.00
.7165	81.00	86.00	90.00	102.00	118.00
.7170	81.00	86.00	90.00	102.00	118.00
.7175	81.00	86.00	90.00	102.00	118.00
.7180	81.00	86.00	90.00	102.00	118.00
.7185	83.00	89.00	94.00	97.00	118.00

Note: Tolerance, Flute Length, Overall Length, and Shank Diameter are comparable to the closest standard size. See pages 4-9.

Chucking Reamers - Straight Shank - H.S. & Cobalt

Intermediate Decimal Sizes

List No. **LV533**: High Speed, Straight Flute

List No. **LV535**: High Speed, Right Hand Spiral, Right Hand Cut

List No. **LV535L**: High Speed, Left Hand Spiral, Right Hand Cut

List No. **1533**: Cobalt, Straight Flute

List No. **1535**: Cobalt, Right Hand Spiral, Right Hand Cut



Size	Price Each				
	LV533 Straight Flute	LV535 RH Spiral	LV535L LH Sp. RH Cut	1533 Cobalt Str. Fit.	1535 Cobalt RH Sp.
.7190	83.00	89.00	94.00	102.00	121.00
.7195	83.00	89.00	94.00	102.00	121.00
.7200	83.00	89.00	94.00	102.00	121.00
.7205	83.00	89.00	94.00	102.00	121.00
.7210	83.00	89.00	94.00	102.00	121.00
.7215	83.00	89.00	94.00	102.00	121.00
.7220	83.00	89.00	94.00	102.00	121.00
.7225	83.00	89.00	94.00	102.00	121.00
.7230	83.00	89.00	94.00	102.00	121.00
.7235	83.00	89.00	94.00	102.00	121.00
.7240	83.00	89.00	94.00	102.00	121.00
.7245	83.00	89.00	94.00	102.00	121.00
.7250	83.00	89.00	94.00	102.00	121.00
.7255	83.00	89.00	94.00	102.00	121.00
.7260	83.00	89.00	94.00	102.00	121.00
.7265	83.00	89.00	94.00	102.00	121.00
.7270	83.00	89.00	94.00	102.00	121.00
.7275	83.00	89.00	94.00	102.00	121.00
.7280	83.00	89.00	94.00	102.00	121.00
.7285	83.00	89.00	94.00	102.00	121.00
.7290	83.00	89.00	94.00	102.00	121.00
.7295	83.00	89.00	94.00	102.00	121.00
.7300	83.00	89.00	94.00	102.00	121.00
.7305	83.00	89.00	94.00	102.00	121.00
.7310	83.00	89.00	94.00	102.00	121.00
.7315	83.00	89.00	94.00	102.00	121.00
.7320	83.00	89.00	94.00	102.00	121.00
.7325	83.00	89.00	94.00	102.00	121.00
.7330	83.00	89.00	94.00	102.00	121.00
.7335	83.00	89.00	94.00	102.00	121.00
.7340	83.00	89.00	94.00	102.00	121.00
.7345	83.00	89.00	94.00	102.00	121.00
.7350	83.00	89.00	94.00	102.00	121.00
.7355	83.00	89.00	94.00	102.00	121.00
.7360	83.00	89.00	94.00	102.00	121.00
.7365	83.00	89.00	94.00	102.00	121.00
.7370	83.00	89.00	94.00	102.00	121.00
.7375	83.00	89.00	94.00	102.00	121.00
.7380	83.00	89.00	94.00	102.00	121.00
.7385	83.00	89.00	94.00	102.00	121.00
.7390	83.00	89.00	94.00	102.00	121.00
.7395	83.00	89.00	94.00	102.00	121.00
.7400	83.00	89.00	94.00	102.00	121.00
.7405	83.00	89.00	94.00	102.00	121.00
.7410	83.00	89.00	94.00	102.00	121.00
.7415	83.00	89.00	94.00	102.00	121.00
.7420	83.00	89.00	94.00	102.00	121.00
.7425	83.00	89.00	94.00	102.00	121.00
.7430	83.00	89.00	94.00	102.00	121.00
.7435	83.00	89.00	94.00	102.00	121.00
.7440	83.00	89.00	94.00	102.00	121.00
.7445	83.00	89.00	94.00	102.00	121.00
.7450	83.00	89.00	94.00	102.00	121.00
.7455	83.00	89.00	94.00	102.00	121.00
.7460	83.00	89.00	94.00	102.00	121.00
.7465	83.00	89.00	94.00	102.00	121.00
.7470	83.00	89.00	94.00	102.00	121.00
.7475	83.00	89.00	94.00	102.00	121.00
.7485	83.00	89.00	94.00	102.00	121.00

Size	Price Each				
	LV533 Straight Flute	LV535 RH Spiral	LV535L LH Sp. RH Cut	1533 Cobalt Str. Fit.	1535 Cobalt RH Sp.
.7490	57.50	72.50	79.00	90.00	101.00
.7495	83.00	89.00	94.00	102.00	121.00
.7505	89.00	95.00	95.00	110.00	130.00
.7510	57.50	72.50	79.00	90.00	101.00
.7515	89.00	95.00	99.50	110.00	130.00
.7520	89.00	95.00	99.50	110.00	130.00
.7525	89.00	95.00	99.50	110.00	130.00
.7530	89.00	95.00	99.50	110.00	130.00
.7535	89.00	95.00	99.50	110.00	130.00
.7540	89.00	95.00	99.50	110.00	130.00
.7545	89.00	95.00	99.50	110.00	130.00
.7550	89.00	95.00	99.50	110.00	130.00
.7555	89.00	95.00	99.50	110.00	130.00
.7560	89.00	95.00	99.50	110.00	130.00
.7565	89.00	95.00	99.50	110.00	130.00
.7570	89.00	95.00	99.50	110.00	130.00
.7575	89.00	95.00	99.50	110.00	130.00
.7580	89.00	95.00	99.50	110.00	130.00
.7585	89.00	95.00	99.50	110.00	130.00
.7590	89.00	95.00	99.50	110.00	130.00
.7595	89.00	95.00	99.50	110.00	130.00
.7600	89.00	95.00	99.50	110.00	130.00
.7605	89.00	95.00	99.50	110.00	130.00
.7610	89.00	95.00	99.50	110.00	130.00
.7615	89.00	95.00	99.50	110.00	130.00
.7620	89.00	95.00	99.50	110.00	130.00
.7625	89.00	95.00	99.50	110.00	130.00
.7630	89.00	95.00	99.50	110.00	130.00
.7635	89.00	95.00	99.50	110.00	130.00
.7640	89.00	95.00	99.50	110.00	130.00
.7645	89.00	95.00	99.50	110.00	130.00
.7650	89.00	95.00	99.50	110.00	130.00
.7655	89.00	95.00	99.50	110.00	130.00
.7660	89.00	95.00	99.50	110.00	130.00
.7665	89.00	95.00	99.50	110.00	130.00
.7670	89.00	95.00	99.50	110.00	130.00
.7675	89.00	95.00	99.50	110.00	130.00
.7680	89.00	95.00	99.50	110.00	130.00
.7685	89.00	95.00	99.50	110.00	130.00
.7690	89.00	95.00	99.50	110.00	130.00
.7695	89.00	95.00	99.50	110.00	130.00
.7700	89.00	95.00	99.50	110.00	130.00
.7705	89.00	95.00	99.50	110.00	130.00
.7710	89.00	95.00	99.50	110.00	130.00
.7715	89.00	95.00	99.50	110.00	130.00
.7720	89.00	95.00	99.50	110.00	130.00
.7725	89.00	95.00	99.50	110.00	130.00
.7730	89.00	95.00	99.50	110.00	130.00
.7735	89.00	95.00	99.50	110.00	130.00
.7740	89.00	95.00	99.50	110.00	130.00
.7745	89.00	95.00	99.50	110.00	130.00
.7750	89.00	95.00	99.50	110.00	130.00
.7755	89.00	95.00	99.50	110.00	130.00
.7760	89.00	95.00	99.50	110.00	130.00
.7765	89.00	95.00	99.50	110.00	130.00
.7770	89.00	95.00	99.50	110.00	130.00
.7775	89.00	95.00	99.50	110.00	130.00
.7780	89.00	95.00	99.50	110.00	130.00
.7785	89.00	95.00	99.50	110.00	130.00

Note: Tolerance, Flute Length, Overall Length, and Shank Diameter are comparable to the closest standard size. See pages 4-9.

Chucking Reamers - Straight Shank - H.S. & Cobalt

Intermediate Decimal Sizes

List No. **LV533**: High Speed, Straight Flute

List No. **LV535**: High Speed, Right Hand Spiral, Right Hand Cut

List No. **LV535L**: High Speed, Left Hand Spiral, Right Hand Cut

List No. **1533**: Cobalt, Straight Flute

List No. **1535**: Cobalt, Right Hand Spiral, Right Hand Cut



Size	Price Each				
	LV533 Straight Flute	LV535 RH Spiral	LV535L LH Sp. RH Cut	1533 Cobalt Str. Fit.	1535 Cobalt RH Sp.
.7790	89.00	95.00	99.50	110.00	130.00
.7795	89.00	95.00	99.50	110.00	130.00
.7800	89.00	95.00	99.50	110.00	130.00
.7805	89.00	95.00	99.50	110.00	130.00
.7810	89.00	95.00	99.50	110.00	130.00
.7815	89.00	95.00	99.50	110.00	130.00
.7820	89.00	95.00	99.50	110.00	130.00
.7825	89.00	95.00	99.50	110.00	130.00
.7830	89.00	95.00	99.50	110.00	130.00
.7835	89.00	95.00	99.50	110.00	130.00
.7840	89.00	95.00	99.50	110.00	130.00
.7845	89.00	95.00	99.50	110.00	130.00
.7850	89.00	95.00	99.50	110.00	130.00
.7855	89.00	95.00	99.50	110.00	130.00
.7860	89.00	95.00	99.50	110.00	130.00
.7865	89.00	95.00	99.50	110.00	130.00
.7870	89.00	95.00	99.50	110.00	130.00
.7875	89.00	95.00	99.50	110.00	130.00
.7880	89.00	95.00	99.50	110.00	130.00
.7885	89.00	95.00	99.50	110.00	130.00
.7890	89.00	95.00	99.50	110.00	130.00
.7895	89.00	95.00	99.50	110.00	130.00
.7900	89.00	95.00	99.50	110.00	130.00
.7905	89.00	95.00	99.50	110.00	130.00
.7910	89.00	95.00	99.50	110.00	130.00
.7915	89.00	95.00	99.50	110.00	130.00
.7920	89.00	95.00	99.50	110.00	130.00
.7925	89.00	95.00	99.50	110.00	130.00
.7930	89.00	95.00	99.50	110.00	130.00
.7935	89.00	95.00	99.50	110.00	130.00
.7940	89.00	95.00	99.50	110.00	130.00
.7945	89.00	95.00	99.50	110.00	130.00
.7950	89.00	95.00	99.50	110.00	130.00
.7955	89.00	95.00	99.50	110.00	130.00
.7960	89.00	95.00	99.50	110.00	130.00
.7965	89.00	95.00	99.50	110.00	130.00
.7970	89.00	95.00	99.50	110.00	130.00
.7975	89.00	95.00	99.50	110.00	130.00
.7980	89.00	95.00	99.50	110.00	130.00
.7985	89.00	95.00	99.50	110.00	130.00
.7990	89.00	95.00	99.50	110.00	130.00
.7995	89.00	95.00	99.50	110.00	130.00
.8000	89.00	95.00	99.50	110.00	130.00
.8005	89.00	95.00	99.50	110.00	130.00
.8010	89.00	95.00	99.50	110.00	130.00
.8015	89.00	95.00	99.50	110.00	130.00
.8020	89.00	95.00	99.50	110.00	130.00
.8025	89.00	95.00	99.50	110.00	130.00
.8030	89.00	95.00	99.50	110.00	130.00
.8035	89.00	95.00	99.50	110.00	130.00
.8040	89.00	95.00	99.50	110.00	130.00
.8045	89.00	95.00	99.50	110.00	130.00
.8050	89.00	95.00	99.50	110.00	130.00
.8055	89.00	95.00	99.50	110.00	130.00
.8060	89.00	95.00	99.50	110.00	130.00
.8065	89.00	95.00	99.50	110.00	130.00
.8070	89.00	95.00	99.50	110.00	130.00
.8075	89.00	95.00	99.50	110.00	130.00
.8080	89.00	95.00	99.50	110.00	130.00

Size	Price Each				
	LV533 Straight Flute	LV535 RH Spiral	LV535L LH Sp. RH Cut	1533 Cobalt Str. Fit.	1535 Cobalt RH Sp.
.8085	89.00	95.00	99.50	110.00	130.00
.8090	89.00	95.00	99.50	110.00	130.00
.8095	89.00	95.00	99.50	110.00	130.00
.8100	89.00	95.00	99.50	110.00	130.00
.8105	89.00	95.00	99.50	110.00	130.00
.8110	89.00	95.00	99.50	110.00	130.00
.8115	59.00	76.50	79.00	102.00	115.00
.8120	89.00	95.00	99.50	110.00	130.00
.8130	93.00	99.00	104.00	125.50	139.00
.8135	59.00	76.50	79.00	102.00	115.00
.8140	93.00	99.00	104.00	125.50	139.00
.8145	93.00	99.00	104.00	125.50	139.00
.8150	93.00	99.00	104.00	125.50	139.00
.8155	93.00	99.00	104.00	125.50	139.00
.8160	93.00	99.00	104.00	125.50	139.00
.8165	93.00	99.00	104.00	125.50	139.00
.8170	95.50	99.00	104.00	125.50	139.00
.8175	95.50	99.00	104.00	125.50	139.00
.8180	95.50	99.00	104.00	125.50	139.00
.8185	95.50	99.00	104.00	125.50	139.00
.8190	95.50	99.00	104.00	125.50	139.00
.8195	95.50	99.00	104.00	125.50	139.00
.8200	95.50	99.00	104.00	125.50	139.00
.8205	95.50	99.00	104.00	125.50	139.00
.8210	95.50	99.00	104.00	125.50	139.00
.8215	95.50	99.00	104.00	125.50	139.00
.8220	95.50	99.00	104.00	125.50	139.00
.8225	95.50	99.00	104.00	125.50	139.00
.8230	95.50	99.00	104.00	125.50	139.00
.8235	95.50	99.00	104.00	125.50	139.00
.8240	95.50	99.00	104.00	125.50	139.00
.8245	95.50	99.00	104.00	125.50	139.00
.8250	95.50	99.00	104.00	125.50	139.00
.8255	95.50	99.00	104.00	125.50	139.00
.8260	95.50	99.00	104.00	125.50	139.00
.8265	95.50	99.00	104.00	125.50	139.00
.8270	95.50	99.00	104.00	125.50	139.00
.8275	95.50	99.00	104.00	125.50	139.00
.8280	95.50	99.00	104.00	125.50	139.00
.8285	95.50	99.00	104.00	125.50	139.00
.8290	95.50	99.00	104.00	125.50	139.00
.8295	95.50	99.00	104.00	125.50	139.00
.8300	95.50	99.00	104.00	125.50	139.00
.8305	95.50	99.00	104.00	125.50	139.00
.8310	95.50	99.00	104.00	125.50	139.00
.8315	95.50	99.00	104.00	125.50	139.00
.8320	95.50	99.00	104.00	125.50	139.00
.8325	95.50	99.00	104.00	125.50	139.00
.8330	95.50	99.00	104.00	125.50	139.00
.8335	95.50	99.00	104.00	125.50	139.00
.8340	95.50	99.00	104.00	125.50	139.00
.8345	95.50	99.00	104.00	125.50	139.00
.8350	95.50	99.00	104.00	125.50	139.00
.8355	95.50	99.00	104.00	125.50	139.00
.8360	95.50	99.00	104.00	125.50	139.00
.8365	95.50	99.00	104.00	125.50	139.00
.8370	95.50	99.00	104.00	125.50	139.00
.8375	95.50	99.00	104.00	125.50	139.00
.8380	95.50	99.00	104.00	125.50	139.00

Note: Tolerance, Flute Length, Overall Length, and Shank Diameter are comparable to the closest standard size. See pages 4-9.

Chucking Reamers - Straight Shank - H.S. & Cobalt

Intermediate Decimal Sizes

List No. **LV533**: High Speed, Straight Flute

List No. **LV535**: High Speed, Right Hand Spiral, Right Hand Cut

List No. **LV535L**: High Speed, Left Hand Spiral, Right Hand Cut

List No. **1533**: Cobalt, Straight Flute

List No. **1535**: Cobalt, Right Hand Spiral, Right Hand Cut



Size	Price Each				
	LV533 Straight Flute	LV535 RH Spiral	LV535L LH Sp. RH Cut	1533 Cobalt Str. Ft.	1535 Cobalt RH Sp.
.8385	95.50	99.00	104.00	125.50	139.00
.8390	95.50	99.00	104.00	125.50	139.00
.8395	95.50	99.00	104.00	125.50	139.00
.8400	95.50	99.00	104.00	125.50	139.00
.8405	95.50	99.00	104.00	125.50	139.00
.8410	95.50	99.00	104.00	125.50	139.00
.8415	95.50	99.00	104.00	125.50	139.00
.8420	95.50	99.00	104.00	125.50	139.00
.8425	95.50	99.00	104.00	125.50	139.00
.8430	95.50	99.00	104.00	125.50	139.00
.8435	95.50	99.00	104.00	125.50	139.00
.8440	97.00	102.00	107.00	114.08	139.00
.8445	97.00	102.00	107.00	114.08	139.00
.8450	97.00	102.00	107.00	114.08	139.00
.8455	97.00	102.00	107.00	114.08	139.00
.8460	97.00	102.00	107.00	114.08	139.00
.8470	97.00	102.00	107.00	114.08	139.00
.8475	97.00	102.00	107.00	114.08	139.00
.8480	97.00	102.00	107.00	114.08	139.00
.8485	97.00	102.00	107.00	114.08	139.00
.8490	97.00	102.00	107.00	114.08	139.00
.8495	97.00	102.00	107.00	114.08	139.00
.8500	97.00	102.00	107.00	114.08	139.00
.8505	97.00	102.00	107.00	114.08	139.00
.8510	97.00	102.00	107.00	114.08	139.00
.8515	97.00	102.00	107.00	114.08	139.00
.8520	97.00	102.00	107.00	114.08	139.00
.8525	97.00	102.00	107.00	114.08	139.00
.8530	97.00	102.00	107.00	114.08	139.00
.8535	97.00	102.00	107.00	114.08	139.00
.8540	97.00	102.00	107.00	114.08	139.00
.8545	97.00	102.00	107.00	114.08	139.00
.8550	97.00	102.00	107.00	114.08	139.00
.8555	97.00	102.00	107.00	114.08	139.00
.8560	97.00	102.00	107.00	114.08	139.00
.8565	97.00	102.00	107.00	114.08	139.00
.8570	97.00	102.00	107.00	114.08	139.00
.8575	97.00	102.00	107.00	114.08	139.00
.8580	97.00	102.00	107.00	114.08	139.00
.8585	97.00	102.00	107.00	114.08	139.00
.8590	97.00	102.00	107.00	114.08	139.00
.8595	97.00	102.00	107.00	114.08	139.00
.8600	97.00	102.00	107.00	114.08	139.00
.8605	97.00	102.00	107.00	114.08	139.00
.8610	97.00	102.00	107.00	114.08	139.00
.8615	97.00	102.00	107.00	114.08	139.00
.8620	97.00	102.00	107.00	114.08	139.00
.8625	97.00	102.00	107.00	114.08	139.00
.8630	97.00	102.00	107.00	114.08	139.00
.8635	97.00	102.00	107.00	114.08	139.00
.8640	97.00	102.00	107.00	114.08	139.00
.8645	97.00	102.00	107.00	114.08	139.00
.8650	97.00	102.00	107.00	114.08	139.00
.8655	97.00	102.00	107.00	114.08	139.00
.8660	97.00	102.00	107.00	114.08	139.00
.8665	97.00	102.00	107.00	114.08	139.00
.8670	97.00	102.00	107.00	114.08	139.00
.8675	97.00	102.00	107.00	114.08	139.00
.8680	97.00	102.00	107.00	114.08	139.00

Size	Price Each				
	LV533 Straight Flute	LV535 RH Spiral	LV535L LH Sp. RH Cut	1533 Cobalt Str. Ft.	1535 Cobalt RH Sp.
.8685	97.00	102.00	107.00	114.08	139.00
.8690	97.00	102.00	107.00	114.08	139.00
.8695	97.00	102.00	107.00	114.08	139.00
.8700	97.00	102.00	107.00	114.08	139.00
.8705	97.00	102.00	107.00	114.08	139.00
.8710	97.00	102.00	107.00	114.08	139.00
.8715	97.00	102.00	107.00	114.08	139.00
.8720	97.00	102.00	107.00	114.08	139.00
.8725	97.00	102.00	107.00	114.08	139.00
.8730	97.00	102.00	107.00	114.08	139.00
.8735	97.00	102.00	107.00	114.08	139.00
.8740	69.00	90.00	99.00	125.00	133.00
.8745	97.00	102.00	107.00	115.00	136.00
.8755	102.00	109.00	113.27	140.00	160.00
.8760	69.00	90.00	99.00	125.00	133.00
.8765	102.00	109.00	113.27	140.00	160.00
.8770	102.00	109.00	113.27	140.00	160.00
.8775	102.00	109.00	113.27	140.00	160.00
.8780	102.00	109.00	113.27	140.00	160.00
.8785	102.00	109.00	113.27	140.00	160.00
.8790	102.00	109.00	113.27	140.00	160.00
.8795	102.00	109.00	113.27	140.00	160.00
.8800	102.00	109.00	113.27	140.00	160.00
.8805	102.00	109.00	113.27	140.00	160.00
.8810	102.00	109.00	113.27	140.00	160.00
.8815	102.00	109.00	113.27	140.00	160.00
.8820	102.00	109.00	113.27	140.00	160.00
.8825	102.00	109.00	113.27	140.00	160.00
.8830	102.00	109.00	113.27	140.00	160.00
.8835	102.00	109.00	113.27	140.00	160.00
.8840	102.00	109.00	113.27	140.00	160.00
.8845	102.00	109.00	113.27	140.00	160.00
.8850	102.00	109.00	113.27	140.00	160.00
.8855	102.00	109.00	113.27	140.00	160.00
.8860	102.00	109.00	113.27	140.00	160.00
.8865	102.00	109.00	113.27	140.00	160.00
.8870	102.00	109.00	113.27	140.00	160.00
.8875	102.00	109.00	113.27	140.00	160.00
.8880	102.00	109.00	113.27	140.00	160.00
.8885	102.00	109.00	113.27	140.00	160.00
.8890	102.00	109.00	113.27	140.00	160.00
.8895	102.00	109.00	113.27	140.00	160.00
.8900	104.00	110.00	116.00	140.00	160.00
.8905	104.00	110.00	116.00	140.00	160.00
.8910	104.00	110.00	116.00	140.00	160.00
.8915	104.00	110.00	116.00	140.00	160.00
.8920	104.00	110.00	116.00	140.00	160.00
.8925	104.00	110.00	116.00	140.00	160.00
.8930	104.00	110.00	116.00	140.00	160.00
.8935	104.00	110.00	116.00	140.00	160.00
.8940	104.00	110.00	116.00	140.00	160.00
.8945	104.00	110.00	116.00	140.00	160.00
.8950	104.00	110.00	116.00	140.00	160.00
.8955	104.00	110.00	116.00	140.00	160.00
.8960	104.00	110.00	116.00	140.00	160.00
.8965	104.00	110.00	116.00	140.00	160.00
.8970	104.00	110.00	116.00	140.00	160.00
.8975	104.00	110.00	116.00	140.00	160.00
.8980	104.00	110.00	116.00	140.00	160.00

Note: Tolerance, Flute Length, Overall Length, and Shank Diameter are comparable to the closest standard size. See pages 4-9.

Chucking Reamers - Straight Shank - H.S. & Cobalt

Intermediate Decimal Sizes

List No. **LV533**: High Speed, Straight Flute

List No. **LV535**: High Speed, Right Hand Spiral, Right Hand Cut

List No. **LV535L**: High Speed, Left Hand Spiral, Right Hand Cut

List No. **1533**: Cobalt, Straight Flute

List No. **1535**: Cobalt, Right Hand Spiral, Right Hand Cut

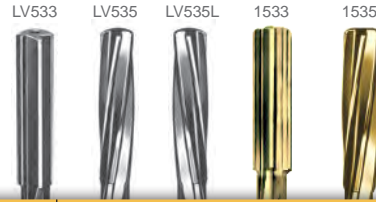

Size	Price Each				
	LV533 Straight Flute	LV535 RH Spiral	LV535L LH Sp. RH Cut	1533 Cobalt Str. Fit.	1535 Cobalt RH Sp.
.8985	104.00	110.00	116.00	140.00	160.00
.8990	104.00	110.00	116.00	140.00	160.00
.8995	104.00	110.00	116.00	140.00	160.00
.9000	104.00	110.00	116.00	140.00	160.00
.9005	104.00	110.00	116.00	140.00	160.00
.9010	104.00	110.00	116.00	140.00	160.00
.9015	104.00	110.00	116.00	140.00	160.00
.9020	104.00	110.00	116.00	140.00	160.00
.9025	104.00	110.00	116.00	140.00	160.00
.9030	104.00	110.00	116.00	140.00	160.00
.9035	104.00	110.00	116.00	140.00	160.00
.9040	104.00	110.00	116.00	140.00	160.00
.9045	104.00	110.00	116.00	140.00	160.00
.9050	104.00	110.00	116.00	140.00	160.00
.9060	104.00	110.00	116.00	140.00	160.00
.9065	104.00	110.00	116.00	140.00	160.00
.9070	104.00	110.00	116.00	140.00	160.00
.9075	104.00	110.00	116.00	140.00	160.00
.9080	105.00	111.00	116.00	140.00	160.00
.9085	105.00	111.00	116.00	140.00	160.00
.9090	105.00	111.00	116.00	140.00	160.00
.9095	105.00	111.00	116.00	140.00	160.00
.9100	105.00	111.00	116.00	140.00	160.00
.9105	105.00	111.00	116.00	140.00	160.00
.9110	105.00	111.00	116.00	140.00	160.00
.9115	105.00	111.00	116.00	140.00	160.00
.9120	105.00	111.00	116.00	140.00	160.00
.9125	105.00	111.00	116.00	140.00	160.00
.9130	105.00	111.00	116.00	140.00	160.00
.9135	105.00	111.00	116.00	140.00	160.00
.9140	105.00	111.00	116.00	140.00	160.00
.9145	105.00	111.00	116.00	140.00	160.00
.9150	105.00	111.00	116.00	140.00	160.00
.9155	105.00	111.00	116.00	140.00	160.00
.9160	105.00	111.00	116.00	140.00	160.00
.9165	105.00	111.00	116.00	140.00	160.00
.9170	105.00	111.00	116.00	140.00	160.00
.9175	105.00	111.00	116.00	140.00	160.00
.9180	105.00	111.00	116.00	140.00	160.00
.9185	105.00	111.00	116.00	140.00	160.00
.9190	105.00	111.00	116.00	140.00	160.00
.9195	105.00	111.00	116.00	140.00	160.00
.9200	105.00	111.00	116.00	140.00	160.00
.9205	106.00	112.00	117.00	140.00	160.00
.9210	106.00	112.00	117.00	140.00	160.00
.9215	106.00	112.00	117.00	140.00	160.00
.9220	106.00	112.00	117.00	140.00	160.00
.9225	106.00	112.00	117.00	140.00	160.00
.9230	106.00	112.00	117.00	140.00	160.00
.9235	106.00	112.00	117.00	140.00	160.00
.9240	106.00	112.00	117.00	140.00	160.00
.9245	106.00	112.00	117.00	140.00	160.00
.9250	106.00	112.00	117.00	140.00	160.00
.9255	106.00	112.00	117.00	140.00	160.00
.9260	106.00	112.00	117.00	140.00	160.00
.9265	106.00	112.00	117.00	140.00	160.00
.9270	106.00	112.00	117.00	140.00	160.00
.9275	106.00	112.00	117.00	140.00	160.00
.9280	106.00	112.00	117.00	140.00	160.00

Size	Price Each				
	LV533 Straight Flute	LV535 RH Spiral	LV535L LH Sp. RH Cut	1533 Cobalt Str. Fit.	1535 Cobalt RH Sp.
.9285	106.00	112.00	117.00	140.00	160.00
.9290	106.00	112.00	117.00	140.00	160.00
.9295	106.00	112.00	117.00	140.00	160.00
.9300	106.00	112.00	117.00	140.00	160.00
.9305	106.00	112.00	117.00	140.00	160.00
.9310	106.00	112.00	117.00	140.00	160.00
.9315	106.00	112.00	117.00	140.00	160.00
.9320	106.00	112.00	117.00	140.00	160.00
.9325	106.00	112.00	117.00	140.00	160.00
.9330	106.00	112.00	117.00	140.00	160.00
.9335	106.00	112.00	117.00	140.00	160.00
.9340	106.00	112.00	117.00	140.00	160.00
.9345	106.00	112.00	117.00	140.00	160.00
.9350	106.00	112.00	117.00	140.00	160.00
.9355	106.00	112.00	117.00	140.00	160.00
.9360	106.00	112.00	117.00	140.00	160.00
.9365	89.90	99.00	----	140.00	152.00
.9370	106.00	112.00	117.00	140.00	160.00
.9380	112.00	121.00	125.00	158.00	170.00
.9385	89.90	99.00	102.00	140.00	152.00
.9390	112.00	121.00	125.00	158.00	170.00
.9395	112.00	121.00	125.00	158.00	170.00
.9400	112.00	121.00	125.00	158.00	170.00
.9405	112.00	121.00	125.00	158.00	170.00
.9410	112.00	121.00	125.00	158.00	170.00
.9415	112.00	121.00	125.00	158.00	170.00
.9420	112.00	121.00	125.00	158.00	170.00
.9425	112.00	121.00	125.00	158.00	170.00
.9430	112.00	121.00	125.00	158.00	170.00
.9435	112.00	121.00	125.00	158.00	170.00
.9440	112.00	121.00	125.00	158.00	170.00
.9445	112.00	121.00	125.00	158.00	170.00
.9450	112.00	121.00	125.00	158.00	170.00
.9455	112.00	121.00	125.00	158.00	170.00
.9460	112.00	121.00	125.00	158.00	170.00
.9465	112.00	121.00	125.00	158.00	170.00
.9470	112.00	121.00	125.00	158.00	170.00
.9475	112.00	121.00	125.00	158.00	170.00
.9480	112.00	121.00	125.00	158.00	170.00
.9485	112.00	121.00	125.00	158.00	170.00
.9490	112.00	121.00	125.00	158.00	170.00
.9495	114.00	122.00	125.00	158.00	170.00
.9500	114.00	122.00	125.00	158.00	170.00
.9505	114.00	122.00	125.00	158.00	170.00
.9510	114.00	122.00	125.00	158.00	170.00
.9515	114.00	122.00	125.00	158.00	170.00
.9520	114.00	122.00	125.00	158.00	170.00
.9525	114.00	122.00	125.00	158.00	170.00
.9530	114.00	122.00	125.00	158.00	170.00
.9535	114.00	122.00	125.00	158.00	170.00
.9540	114.00	122.00	125.00	158.00	170.00
.9545	114.00	122.00	125.00	158.00	170.00
.9550	114.00	122.00	125.00	158.00	170.00
.9555	114.00	122.00	125.00	158.00	170.00
.9560	114.00	122.00	125.00	158.00	170.00
.9565	114.00	122.00	125.00	158.00	170.00
.9570	114.00	122.00	125.00	158.00	170.00
.9575	114.00	122.00	125.00	158.00	170.00
.9580	114.00	122.00	125.00	158.00	170.00

Note: Tolerance, Flute Length, Overall Length, and Shank Diameter are comparable to the closest standard size. See pages 4-9.

Chucking Reamers - Straight Shank - H.S. & Cobalt

Intermediate Decimal Sizes

List No. **LV533**: High Speed, Straight Flute

List No. **LV535**: High Speed, Right Hand Spiral, Right Hand Cut

List No. **LV535L**: High Speed, Left Hand Spiral, Right Hand Cut

List No. **1533**: Cobalt, Straight Flute

List No. **1535**: Cobalt, Right Hand Spiral, Right Hand Cut

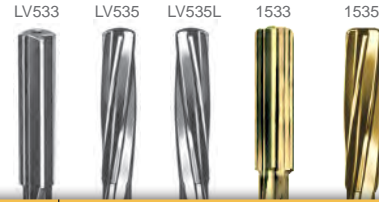

Size	Price Each				
	LV533 Straight Flute	LV535 RH Spiral	LV535L LH Sp. RH Cut	1533 Cobalt Str. Fit.	1535 Cobalt RH Sp.
.9585	114.00	122.00	125.00	158.00	170.00
.9590	114.00	122.00	125.00	158.00	170.00
.9595	114.00	122.00	125.00	158.00	170.00
.9600	114.00	122.00	125.00	158.00	170.00
.9605	115.00	123.00	125.00	158.00	170.00
.9610	115.00	123.00	125.00	158.00	170.00
.9615	115.00	123.00	125.00	158.00	170.00
.9620	115.00	123.00	125.00	158.00	170.00
.9625	115.00	123.00	125.00	158.00	170.00
.9630	115.00	123.00	125.00	158.00	170.00
.9635	115.00	123.00	125.00	158.00	170.00
.9640	115.00	123.00	125.00	158.00	170.00
.9645	115.00	123.00	125.00	158.00	170.00
.9650	115.00	123.00	125.00	158.00	170.00
.9655	115.00	123.00	125.00	158.00	170.00
.9660	115.00	123.00	125.00	158.00	170.00
.9665	115.00	123.00	125.00	158.00	170.00
.9670	115.00	123.00	125.00	158.00	170.00
.9675	115.00	123.00	125.00	158.00	170.00
.9680	115.00	123.00	125.00	158.00	170.00
.9685	115.00	123.00	127.00	169.00	182.00
.9690	115.00	123.00	127.00	169.00	182.00
.9695	115.00	123.00	127.00	169.00	182.00
.9700	115.00	123.00	127.00	169.00	182.00
.9705	115.00	123.00	127.00	169.00	182.00
.9710	115.00	123.00	127.00	169.00	182.00
.9715	115.00	123.00	127.00	169.00	182.00
.9720	115.00	123.00	127.00	169.00	182.00
.9725	115.00	123.00	127.00	169.00	182.00
.9730	115.00	123.00	127.00	169.00	182.00
.9735	115.00	123.00	127.00	169.00	182.00
.9740	115.00	123.00	127.00	169.00	182.00
.9745	115.00	123.00	127.00	169.00	182.00
.9750	115.00	123.00	127.00	169.00	182.00
.9755	115.00	123.00	127.00	169.00	182.00
.9760	115.00	123.00	127.00	169.00	182.00
.9765	115.00	123.00	127.00	169.00	182.00
.9770	115.00	123.00	127.00	169.00	182.00
.9775	115.00	123.00	127.00	169.00	182.00
.9780	115.00	123.00	127.00	169.00	182.00
.9785	115.00	123.00	127.00	169.00	182.00
.9790	115.00	123.00	127.00	169.00	182.00
.9795	115.00	123.00	127.00	169.00	182.00
.9800	115.00	123.00	127.00	169.00	182.00
.9805	115.00	123.00	127.00	169.00	182.00
.9810	115.00	123.00	127.00	169.00	182.00
.9815	115.00	123.00	127.00	169.00	182.00
.9820	115.00	123.00	127.00	169.00	182.00
.9825	115.00	123.00	127.00	169.00	182.00
.9830	115.00	123.00	127.00	169.00	182.00
.9835	115.00	123.00	127.00	169.00	182.00
.9840	115.00	123.00	127.00	169.00	182.00
.9845	115.00	123.00	127.00	169.00	182.00
.9850	115.00	123.00	127.00	169.00	182.00
.9855	116.00	124.00	129.00	169.00	182.00
.9860	116.00	124.00	129.00	169.00	182.00
.9865	116.00	124.00	129.00	169.00	182.00
.9870	116.00	124.00	129.00	169.00	182.00

Size	Price Each				
	LV533 Straight Flute	LV535 RH Spiral	LV535L LH Sp. RH Cut	1533 Cobalt Str. Fit.	1535 Cobalt RH Sp.
.9875	116.00	124.00	129.00	169.00	182.00
.9880	116.00	124.00	129.00	169.00	182.00
.9885	116.00	124.00	129.00	169.00	182.00
.9890	116.00	124.00	129.00	169.00	182.00
.9895	116.00	124.00	129.00	169.00	182.00
.9900	116.00	124.00	129.00	169.00	182.00
.9905	116.00	124.00	129.00	169.00	182.00
.9910	116.00	124.00	129.00	169.00	182.00
.9915	116.00	124.00	129.00	169.00	182.00
.9920	116.00	124.00	129.00	169.00	182.00
.9925	116.00	124.00	129.00	169.00	182.00
.9930	116.00	124.00	129.00	169.00	182.00
.9935	116.00	124.00	129.00	169.00	182.00
.9940	116.00	124.00	129.00	169.00	182.00
.9945	116.00	124.00	129.00	169.00	182.00
.9950	116.00	124.00	129.00	169.00	182.00
.9955	116.00	124.00	129.00	169.00	182.00
.9960	116.00	124.00	129.00	169.00	182.00
.9965	116.00	124.00	129.00	169.00	182.00
.9970	116.00	124.00	129.00	169.00	182.00
.9975	116.00	124.00	129.00	169.00	182.00
.9980	116.00	124.00	129.00	169.00	182.00
.9985	116.00	124.00	129.00	169.00	182.00
.9990	81.00	104.00	----	148.00	160.00
.9995	116.00	124.00	129.00	169.00	182.00
1.0005	155.00	----	----	----	190.00
1.0010	85.75	104.40	110.00	148.00	160.00
1.0020	155.00	----	----	----	190.00
1.0030	155.00	----	----	----	190.00
1.0050	155.00	----	----	----	190.00
1.0100	160.00	----	----	----	190.00
1.0160	----	----	----	----	190.00
1.0580	----	----	----	----	190.00
1.0740	----	----	----	----	225.00
1.0790	190.00	----	----	----	225.00
1.1024	190.00	----	----	----	----
1.1255	190.00	----	----	----	225.00
1.1270	190.00	----	----	----	225.00
1.1690	190.00	----	----	----	225.00
1.1800	190.00	----	----	----	225.00
1.1821	190.00	----	----	----	----
1.1920	199.00	----	----	----	----
1.2010	199.00	----	----	----	----
1.2196	210.00	----	----	----	----
1.2205	220.00	----	----	----	----
1.2460	225.00	----	----	----	225.00
1.2470	----	----	----	----	225.00
1.2495	----	----	----	----	225.00
1.2520	----	----	----	----	270.00
1.2550	----	----	----	----	270.00
1.3050	----	----	----	----	270.00
1.3390	250.00	----	----	----	310.00
1.3740	180.00	----	----	----	310.00
1.3780	----	----	----	----	310.00
1.4380	----	----	275.00	----	----
1.4805	280.00	----	----	----	----
1.5005	----	275.00	----	----	----

Note: Tolerance, Flute Length, Overall Length, and Shank Diameter are comparable to the closest standard size. See pages 4-9.

Dowel Pin Reamers - Standard Length High Speed Steel & Cobalt



- List No. **LV570DP**: High Speed, Straight Flute
 List No. **LV575DP**: High Speed, Right Hand Spiral, Right Hand Cut
 List No. **1570DP**: Cobalt, Straight Flute
 List No. **1575DP**: Cobalt, Right Hand Spiral, Right Hand Cut

Dowel pin reamers are made to a minus tolerance, while all other reamers are made to a plus tolerance. They are designed to prepare perfect size holes for dowel pin insertion.

Diameter Tolerance:	Through 1/2"	+0.000" +.000m/m	-0.002" -.005m/m
----------------------------	--------------	------------------	------------------

LV570DP LV575DP 1570DP 1575DP

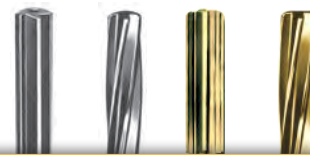

Specifications				Price Each			
Diameter	Flute Length	Overall Length	Shank Diameter	LV570DP Straight Flute	LV575DP RH Spiral	1570DP Cobalt Str. Flt.	1575DP Cobalt RH Sp.
.1230	7/8	3 1/2	.1190	13.50	16.00	16.00	17.50
.1240	7/8	3 1/2	.1190	13.50	----	----	----
.1247	7/8	3 1/2	.1190	13.50	16.00	16.00	17.50
.1280	7/8	3 1/2	.1190	13.50	----	----	----
.1855	1 1/8	4 1/2	.1805	17.50	19.50	19.50	22.00
.1870	1 1/8	4 1/2	.1805	17.50	19.50	19.50	22.00
.2480	1 1/2	6	.2405	18.70	21.00	21.50	24.50
.2495	1 1/2	6	.2405	18.70	21.00	21.50	24.50
.3105	1 1/2	6	.2792	22.40	24.75	30.50	32.50
.3120	1 1/2	6	.2792	22.40	24.75	30.50	32.50
.3730	1 3/4	7	.3105	25.00	28.00	33.50	34.70
.3745	1 3/4	7	.3105	25.00	28.00	33.50	34.70
.4355	1 3/4	7	.3730	27.25	32.90	42.00	45.00
.4370	1 3/4	7	.3730	27.25	32.90	42.00	45.00
.4980	2	8	.4355	29.90	35.50	49.00	52.00
.4995	2	8	.4355	29.90	35.50	49.00	52.00

Dowel Pin Reamers - Production/CNC/Jobber Length High Speed Steel

- List No. **DL570DP**: Straight Flute - Drill Length
 List No. **DL575DP**: Right Hand Spiral, Right Hand Cut - Drill Length



This series is made identical in length with the jobber series drill. This allows for interchangeability of tools and eliminates costly setups. Shorter length provides extra rigidity and strength in tough materials.

Specifications				Price Each	
Diameter	Flute Length	Overall Length	Shank Diameter	DL570DP Str. Shank Str. Flute	DL575DP Str. Shank RH Sp/Cut
.1230	7/8	2 3/4	.1230	12.29	14.70
.1247	7/8	2 3/4	.1247	12.29	14.70
.1855	1 1/8	3 1/2	.1855	16.00	20.00
.1870	1 1/8	3 1/2	.1870	16.00	20.00
.2480	1 1/2	4	.2480	18.50	21.00
.2495	1 1/2	4	.2495	18.50	21.00
.3105	1 1/2	4 1/2	.3105	21.11	22.12
.3120	1 1/2	4 1/2	.3120	21.11	22.12
.3730	1 3/4	5	.3730	22.68	26.86
.3745	1 3/4	5	.3745	22.68	26.86
.4355	1 3/4	5 1/2	.4355	26.90	29.37
.4370	1 3/4	5 1/2	.4370	26.90	29.37
.4980	2	5 7/8	.4980	30.20	33.50
.4995	2	6	.4995	30.20	33.50

Sets - Dowel Pin Reamers 14 piece sets, sizes .1230 to .4995

Description	Flute Type	Case Type	Set No.	Price
H.S. Standard Length	Straight	Wood	LV570-70W	357.50
H.S. Standard Length	Straight	Plastic	LV570-70P	318.50
Cobalt Standard Length	Straight	Wood	1570DP-W	491.00
Cobalt Standard Length	Straight	Plastic	1570DP-P	434.00
H.S. Standard Length	RH Spiral	Wood	LV575-71W	422.30
H.S. Standard Length	RH Spiral	Plastic	LV575-71P	365.30
Cobalt Standard Length	RH Spiral	Wood	1575DP-W	523.40
Cobalt Standard Length	RH Spiral	Plastic	1575DP-P	466.40
H.S. Jobber Length	Straight	Plastic	LVDL570-73P	305.36
H.S. Jobber Length	RH Spiral	Plastic	LVDL575-74P	345.10



* Drills are 1/64 smaller than Reamers

Chucking Reamers - Production/CNC/Jobber Length

High Speed Steel

Shank diameter is same as cutting diameter - Drill Length

List No. **DL533**: High Speed, Straight Flute

List No. **DL535**: High Speed, Right Hand Spiral, Right Hand Cut



This series is made identical in length with the jobber series drill. This allows for interchangeability of tools and eliminates costly setup. Shorter length provides extra rigidity and strength in tough materials. In addition, this series provides cost savings.

Specifications					Price Each	
Diameter	Decimal Equivalent	Flute Length	Overall Length	Shank Diameter	DL533 Str. Shank Str. Flute	DL535 Str. Shank RH Sp/Cut
# 60	.0400	1/2	1 5/8	.0400	13.43	16.03
# 59	.0410	1/2	1 5/8	.0410	13.43	16.03
# 58	.0420	1/2	1 5/8	.0420	13.43	16.03
# 57	.0430	1/2	1 3/4	.0430	13.43	16.03
# 56	.0465	1/2	1 3/4	.0465	13.43	16.03
3/64	.0469	1/2	1 3/4	.0469	13.43	16.03
# 55	.0520	1/2	1 7/8	.0520	13.43	16.03
# 54	.0550	1/2	1 7/8	.0550	13.43	16.03
1.50mm	.0591	1/2	1 7/8	.0591	13.43	----
# 53	.0595	1/2	1 7/8	.0595	13.43	16.03
.0600	.0600	1/2	1 7/8	.0600	15.00	----
.0615	.0615	1/2	1 7/8	.0615	15.00	----
Under 1/16	.0620	1/2	1 7/8	.0620	15.00	----
1/16	.0625	1/2	1 7/8	.0625	12.66	16.03
# 52	.0635	1/2	1 7/8	.0635	12.66	16.03
.0660	.0660	3/4	2	.0660	15.00	----
# 51	.0670	3/4	2	.0670	11.41	13.00
# 50	.0700	3/4	2	.0700	11.41	13.00
.0705	.0705	3/4	2	.0705	11.41	----
# 49	.0730	3/4	2	.0730	11.41	13.00
# 48	.0760	3/4	2	.0760	11.41	13.00
5/64	.0781	3/4	2	.0781	11.41	13.00
# 47	.0785	3/4	2	.0785	11.41	13.00
# 46	.0810	3/4	2 1/8	.0810	11.41	13.00
# 45	.0820	3/4	2 1/8	.0820	11.41	13.00
# 44	.0860	3/4	2 1/8	.0860	11.41	13.00
# 43	.0890	3/4	2 1/4	.0890	11.41	13.00
# 42	.0935	3/4	2 1/4	.0935	11.41	13.00
3/32	.0938	3/4	2 1/4	.0938	11.41	13.00
# 41	.0960	7/8	2 3/8	.0960	11.41	13.00
# 40	.0980	7/8	2 3/8	.0980	11.41	13.00
# 39	.0995	7/8	2 3/8	.0995	11.41	13.00
# 38	.1015	7/8	2 1/2	.1015	11.41	13.00
# 37	.1040	7/8	2 1/2	.1040	11.41	13.00
# 36	.1065	7/8	2 1/2	.1065	11.41	13.00
7/64	.1094	7/8	2 5/8	.1094	11.41	13.00
# 35	.1100	7/8	2 5/8	.1100	11.41	13.00
# 34	.1110	7/8	2 5/8	.1110	11.41	13.00
# 33	.1130	7/8	2 5/8	.1130	11.41	13.00
# 32	.1160	7/8	2 3/4	.1160	11.41	13.00
# 31	.1200	7/8	2 3/4	.1200	11.41	13.00
Under 1/8	.1240	7/8	2 3/4	.1240	11.41	13.00
1/8	.1250	7/8	2 3/4	.1250	9.21	13.00
Over 1/8	.1260	7/8	2 3/4	.1260	11.41	13.00
# 30	.1285	7/8	2 3/4	.1285	11.41	13.00
# 29	.1360	1	2 7/8	.1360	15.60	16.35
# 28	.1405	1	2 7/8	.1405	15.60	16.35
9/64	.1406	1	2 7/8	.1406	15.60	16.35
# 27	.1440	1	3	.1440	15.60	16.35
# 26	.1470	1	3	.1470	15.60	16.35
# 25	.1495	1	3	.1495	15.60	16.35
# 24	.1520	1	3 1/8	.1520	15.60	16.35
# 23	.1540	1	3 1/8	.1540	15.60	16.35
5/32	.1562	1	3 1/8	.1562	15.60	16.35
# 22	.1570	1	3 1/8	.1570	15.60	16.35

Diameter Tolerance: $-.0000''$ $-.000m/m$
 $+.0002''$ $+.005m/m$

Chucking Reamers - Production/CNC/Jobber Length

High Speed Steel

Shank diameter is same as cutting diameter - Drill Length

List No. **DL533**: High Speed, Straight Flute

List No. **DL535**: High Speed, Right Hand Spiral, Right Hand Cut



This series is made identical in length with the jobber series drill. This allows for interchangeability of tools and eliminates costly setup. Shorter length provides extra rigidity and strength in tough materials. In addition, this series provides cost savings.

Specifications					Price Each	
Diameter	Decimal Equivalent	Flute Length	Overall Length	Shank Diameter	DL533 Str. Shank Str. Flute	DL535 Str. Shank RH Sp/Cut
# 21	.1590	1 1/8	3 1/4	.1590	15.60	16.35
# 20	.1610	1 1/8	3 1/4	.1610	15.60	16.35
# 19	.1660	1 1/8	3 1/4	.1660	15.60	16.35
# 18	.1695	1 1/8	3 1/4	.1695	15.60	16.35
11/64	.1719	1 1/8	3 1/4	.1719	15.60	16.35
# 17	.1730	1 1/8	3 3/8	.1730	15.60	16.35
# 16	.1770	1 1/8	3 3/8	.1770	15.60	16.35
# 15	.1800	1 1/8	3 3/8	.1800	16.35	17.37
# 14	.1820	1 1/8	3 3/8	.1820	16.35	17.37
# 13	.1850	1 1/8	3 1/2	.1850	16.35	17.37
Under 3/16	.1865	1 1/8	3 1/2	.1865	16.35	17.37
4.75mm	.1870	1 1/8	3 1/2	.1870	18.35	----
3/16	.1875	1 1/8	3 1/2	.1875	12.45	17.37
Over 3/16	.1885	1 1/8	3 1/2	.1885	16.35	17.37
# 12	.1890	1 1/8	3 1/2	.1890	16.35	17.37
# 11	.1910	1 1/4	3 1/2	.1910	17.24	19.02
# 10	.1935	1 1/4	3 5/8	.1935	17.24	19.02
# 9	.1960	1 1/4	3 5/8	.1960	17.24	19.02
# 8	.1990	1 1/4	3 5/8	.1990	17.24	19.02
# 7	.2010	1 1/4	3 5/8	.2010	17.24	19.02
13/64	.2031	1 1/4	3 5/8	.2031	17.24	19.02
# 6	.2040	1 1/4	3 3/4	.2040	17.24	19.02
# 5	.2055	1 1/4	3 3/4	.2055	17.24	19.02
# 4	.2090	1 1/4	3 3/4	.2090	17.24	19.02
# 3	.2130	1 1/4	3 3/4	.2130	17.24	19.02
7/32	.2188	1 1/4	3 3/4	.2188	17.24	19.02
# 2	.2210	1 1/4	3 7/8	.2210	17.24	19.02
# 1	.2280	1 1/2	3 7/8	.2280	17.24	19.02
A	.2340	1 1/2	3 7/8	.2340	17.24	19.02
15/64	.2344	1 1/2	3 7/8	.2344	17.24	19.02
B	.2380	1 1/2	4	.2380	18.24	19.02
C	.2420	1 1/2	4	.2420	18.24	19.02
D	.2460	1 1/2	4	.2460	18.24	19.02
Under 1/4	.2490	1 1/2	4	.2490	18.24	19.02
1/4 (E)	.2500	1 1/2	4	.2500	15.47	17.47
Over 1/4	.2510	1 1/2	4	.2510	18.24	19.02
F	.2570	1 1/2	4 1/8	.2570	18.24	19.02
G	.2610	1 1/2	4 1/8	.2610	18.24	21.00
17/64	.2656	1 1/2	4 1/8	.2656	18.24	21.00
H	.2660	1 1/2	4 1/8	.2660	20.07	21.00
I	.2720	1 1/2	4 1/8	.2720	20.07	21.00
J	.2770	1 1/2	4 1/8	.2770	20.07	21.00
K	.2810	1 1/2	4 1/8	.2810	20.07	21.00
9/32	.2812	1 1/2	4 1/4	.2812	20.07	21.00
7.20mm	.2835	1 1/2	4 1/4	.2835	22.00	----
L	.2900	1 1/2	4 1/4	.2900	20.07	21.00
M	.2950	1 1/2	4 1/4	.2950	20.07	21.00
19/64	.2969	1 1/2	4 3/8	.2969	20.07	21.00
N	.3020	1 1/2	4 3/8	.3020	20.07	21.00
Under 5/16	.3115	1 1/2	4 1/2	.3115	20.07	21.00
5/16	.3125	1 1/2	4 1/2	.3125	18.08	21.00
Over 5/16	.3135	1 1/2	4 1/2	.3135	20.07	21.00
O	.3160	1 1/2	4 1/2	.3160	21.59	23.50
P	.3230	1 1/2	4 5/8	.3230	21.59	23.50
21/64	.3281	1 1/2	4 5/8	.3281	21.59	23.50

Diameter Tolerance: $-.0000''$ $-.000m/m$
 $+.0002''$ $+.005m/m$

Chucking Reamers - Production/CNC/Jobber Length

High Speed Steel

Shank diameter is same as cutting diameter - Drill Length

List No. **DL533**: High Speed, Straight Flute

List No. **DL535**: High Speed, Right Hand Spiral, Right Hand Cut



This series is made identical in length with the jobber series drill. This allows for interchangeability of tools and eliminates costly setup. Shorter length provides extra rigidity and strength in tough materials. In addition, this series provides cost savings.

Specifications					Price Each	
Diameter	Decimal Equivalent	Flute Length	Overall Length	Shank Diameter	DL533 Str. Shank Str. Flute	DL535 Str. Shank RH Sp/Cut
Q	.3320	1 1/2	4 3/4	.3320	21.59	23.50
R	.3390	1 1/2	4 3/4	.3390	21.59	23.50
11/32	.3438	1 1/2	4 3/4	.3438	21.59	23.50
S	.3480	1 3/4	4 7/8	.3480	21.59	23.50
T	.3580	1 3/4	4 7/8	.3580	21.59	23.50
23/64	.3594	1 3/4	4 7/8	.3594	21.59	23.50
U	.3680	1 3/4	5	.3680	21.59	23.50
Under 3/8	.3740	1 3/4	5	.3740	21.59	23.50
3/8	.3750	1 3/4	5	.3750	19.20	23.50
Over 3/8	.3760	1 3/4	5	.3760	21.59	23.50
V	.3770	1 3/4	5	.3770	24.13	26.50
W	.3860	1 3/4	5 1/8	.3860	24.13	26.50
25/64	.3906	1 3/4	5 1/8	.3906	24.13	26.50
X	.3970	1 3/4	5 1/8	.3970	24.13	26.50
Y	.4040	1 3/4	5 1/4	.4040	25.05	26.50
13/32	.4062	1 3/4	5 1/4	.4062	25.05	26.50
Z	.4130	1 3/4	5 1/4	.4130	25.05	26.50
27/64	.4219	1 3/4	5 3/8	.4219	25.05	26.50
Under 7/16	.4365	1 3/4	5 1/2	.4365	25.05	26.50
7/16	.4375	1 3/4	5 1/2	.4375	23.73	26.50
Over 7/16	.4385	1 3/4	5 1/2	.4385	25.05	26.50
29/64	.4531	1 3/4	5 5/8	.4531	27.26	29.50
15/32	.4688	1 3/4	5 3/4	.4688	27.26	29.50
31/64	.4844	2	5 7/8	.4844	27.26	29.50
Under 1/2	.4990	2	5 7/8	.4990	27.26	29.50
1/2	.5000	2	6	.5000	25.05	29.50
Over 1/2	.5010	2	6	.5010	27.26	29.50

Diameter Tolerance: - .0000" - .000m/m
+ .0002" + .005m/m

Sets - Production/CNC/Jobber Length Reamers

These sets provide a method of maintaining a complete stock of reamers in ranges to suit your requirements. A stock on a machinist's workbench saves many trips to the tool crib.

Description	Sizes	Pieces	Case Type	Set No.	Price
H.S. Straight Flute	1/16 - 1/4 by 64 ^{ths}	13	Metal	LVDL533-5M	190.67
H.S. Straight Flute	1/16 - 1/2 by 32 ^{nds}	15	Metal	LVDL533-46M	292.44
H.S. Straight Flute	1/16 - 1/2 by 64 ^{ths}	29	Metal	LVDL533-7M	590.69
H.S. RH Spiral	1/16 - 1/2 by 32 ^{nds}	15	Metal	LVDL535-47M	328.84
H.S. RH Spiral	1/16 - 1/2 by 64 ^{ths}	29	Metal	LVDL535-9M	626.91
H.S. Straight Flute	#1 - #60	60	Metal	LVDL533-12M	847.50
H.S. RH Spiral	#1 - #60	60	Metal	LVDL535-14M	953.47
H.S. Straight Flute	A - Z	26	Metal	LVDL533-22M	556.22
H.S. RH Spiral	A - Z	26	Metal	LVDL535-24M	595.77
H.S. Straight Flute	.1240 - .5010	14	Plastic	LVDL533-33P	289.94
H.S. RH Spiral	.1240 - .5010	14	Plastic	LVDL535-34P	309.78
H.S. Straight Flute	#1 - #60, A - Z, 1/16 - 1/2 by 64 ^{ths}	115	Metal	LVDL533-50M	1988.84
H.S. RH Spiral	#1 - #60, A - Z, 1/16 - 1/2 by 64 ^{ths}	115	Metal	LVDL535-51M	2172.92

Diameter Tolerance: - .0000" - .000m/m
+ .0002" + .005m/m



LVDL533-7M



LVDL533-33P

Extra Long Chucking Reamers Straight Shank - High Speed Steel

List No. LV533XL: High Speed, Straight Flute



Specifications					Price Each
Diameter	Decimal Equivalent	Flute Length	Overall Length	Shank Diameter	LV533XL Str. Shank Str. Flute
1/8	.1250	7/8	6	.1190	16.28
1/8	.1250	7/8	8	.1190	17.93
1/8	.1250	7/8	12	.1190	36.85
5/32	.1562	1	6	.1510	23.10
5/32	.1562	1	8	.1510	25.25
5/32	.1562	1	12	.1510	39.60
3/16	.1875	1 1/8	6	.1805	23.10
3/16	.1875	1 1/8	8	.1805	25.25
3/16	.1875	1 1/8	12	.1805	39.60
7/32	.2188	1 1/4	8	.2075	32.73
7/32	.2188	1 1/4	12	.2075	41.03
1/4	.2500	1 1/2	8	.2405	27.17
1/4	.2500	1 1/2	12	.2405	41.03
5/16	.3125	1 1/2	12	.2792	43.95
3/8	.3750	1 3/4	12	.3105	47.19
7/16	.4375	1 3/4	12	.3730	54.62
1/2	.5000	2	12	.4355	59.95
9/16	.5625	2	12	.4355	69.85
5/8	.6250	2 1/4	12	.5620	81.35
11/16	.6875	2 1/4	12	.5620	92.40

Silver & Deming Reamers - High Speed Steel 6" Overall Length – 1/2" X 2" Long Shank

List No. LV5303: Straight Flute



The shorter length provides extra rigidity and strength in tough materials. They are ideal for Bridgeport, and hand-held applications.

Diameter	Decimal Equivalent	Flute Length	Price Each
17/32	.5312	2	37.52
9/16	.5625	2	42.21
5/8	.6250	2 1/4	46.90
21/32	.6562	2 1/4	51.58
11/16	.6875	2 1/4	52.95
3/4	.7500	2 1/2	57.93
13/16	.8125	2 1/2	67.78

Diameter	Decimal Equivalent	Flute Length	Price Each
7/8	.8750	2 5/8	74.70
1	1.0000	2 3/4	92.76
1 1/8	1.1250	2 7/8	113.71
1 1/4	1.2500	3	140.82
1 3/8	1.3750	3 1/4	168.78
1 1/2	1.5000	3 1/2	198.12

Diameter Tolerance

1/2" Through 5/8": -.0000" -.000m/m +.0003" +.008m/m	21/32" Through 1": +.0001" +.0025m/m +.0005" +.012m/m	1-1/8" Through 1-1/2": +.0002" -.000m/m +.0006" +.016m/m
--	---	--

Sets - Silver & Deming Reamers

Sizes	Description	No. of Pieces	Set No.	Price
5/8, 11/16, 3/4, 13/16, 7/8, 1	1/2" Shank Reamer Set	6	LV75	400.14
5/8, 11/16, 3/4, 13/16, 7/8, 1 (Reamers) 39/64, 43/64, 47/64, 51/64, 55/64, 63/64 (Drills)	1/2" Shank Reamer & Drill Set	12	LV77	589.64
5/8, 11/16, 3/4, 13/16, 7/8 1, 1 1/8, 1 1/4, 1 3/8, 1 1/2	1/2" Shank Reamer Set	10	LV76	1022.56

Supplied in Wood Block

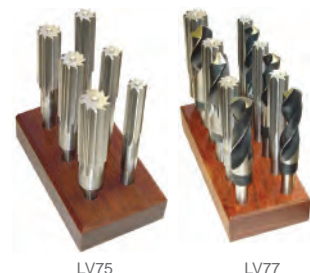

Solid Carbide Chucking Reamers

List No. **C805**: Straight Shank, Straight Flute
Shank diameter same as cutting diameter



- 4 flutes on sizes up to .255" diameter
- 6 flutes on sizes .255" diameter and above
- Cutting flutes are precision ground
- Close tolerances and consistent tool accuracy.

Fractional Sizes

Size	Decimal Equivalent	Flute Length	Overall Length	Price Each
1/32	.0313	1/4	1 1/8	22.55
3/64	.0469	3/8	1 1/2	23.90
1/16	.0625	3/8	1 1/2	22.55
5/64	.0781	1/2	1 3/4	24.71
3/32	.0938	1/2	2	23.45
7/64	.1094	5/8	2 1/4	27.27
1/8	.1250	5/8	2 1/4	25.97
9/64	.1406	3/4	2 1/4	29.48
5/32	.1562	3/4	2 1/4	30.51
11/64	.1719	7/8	2 3/4	35.87
3/16	.1875	7/8	2 3/4	36.18
13/64	.2031	1	3	43.43
7/32	.2188	1	3	39.65
15/64	.2344	1	3	50.90
1/4	.2500	1	3	47.21
17/64	.2656	1 1/8	3 1/4	57.15
9/32	.2812	1 1/8	3 1/4	56.66
19/64	.2969	1 1/8	3 1/4	67.05

Size	Decimal Equivalent	Flute Length	Overall Length	Price Each
5/16	.3125	1 1/8	3 1/4	63.81
21/64	.3281	1 1/4	3 1/2	85.01
11/32	.3438	1 1/4	3 1/2	85.01
23/64	.3594	1 1/4	3 1/2	86.13
3/8	.3750	1 1/4	3 1/2	80.33
25/64	.3906	1 1/4	3 1/2	88.83
13/32	.4062	1 1/4	3 1/2	88.83
27/64	.4219	1 3/8	4	95.09
7/16	.4375	1 3/8	4	89.10
29/64	.4531	1 1/2	4	121.50
15/32	.4688	1 1/2	4	121.50
31/64	.4844	1 1/2	4	127.80
1/2	.5000	1 1/2	4	127.80
9/16	.5625	1 1/2	4	186.30
39/64	.6094	1 1/2	4	186.30
5/8	.6250	1 1/2	4	186.30
3/4	.7500	1 3/4	4	248.40

Letter Sizes

Size	Decimal Equivalent	Flute Length	Overall Length	Price Each
A	.2340	1	3	50.90
B	.2380	1	3	51.93
C	.2420	1	3	51.93
D	.2460	1	3	51.93
E	.2500	1	3	47.21
F	.2570	1 1/8	3 1/4	57.15
G	.2610	1 1/8	3 1/4	57.15
H	.2660	1 1/8	3 1/4	57.15
I	.2720	1 1/8	3 1/4	57.15
J	.2770	1 1/8	3 1/4	57.15
K	.2810	1 1/8	3 1/4	61.92
L	.2900	1 1/8	3 1/4	67.01
M	.2950	1 1/8	3 1/4	67.01

Size	Decimal Equivalent	Flute Length	Overall Length	Price Each
N	.3020	1 1/8	3 1/4	69.89
O	.3160	1 1/8	3 1/4	73.35
P	.3230	1 1/4	3 1/2	74.30
Q	.3320	1 1/4	3 1/2	85.01
R	.3390	1 1/4	3 1/2	85.01
S	.3480	1 1/4	3 1/2	85.37
T	.3580	1 1/4	3 1/2	85.73
U	.3680	1 1/4	3 1/2	87.26
V	.3770	1 1/4	3 1/2	89.91
W	.3860	1 1/4	3 1/2	98.60
X	.3970	1 1/4	3 1/2	100.08
Y	.4040	1 1/4	3 1/2	102.29
Z	.4130	1 1/4	3 1/2	106.20

Number Sizes

Size	Decimal Equivalent	Flute Length	Overall Length	Price Each
1	.2280	1	3	50.90
2	.2210	1	3	48.47
3	.2130	1	3	43.43
4	.2090	1	3	45.68
5	.2055	1	3	43.43
6	.2040	1	3	43.43
7	.2010	1	3	43.43
8	.1990	1	3	42.08
9	.1960	1	3	41.90
10	.1935	1	3	40.46
11	.1910	7/8	2 3/4	40.19
12	.1890	7/8	2 3/4	39.74
13	.1850	7/8	2 3/4	37.67
14	.1820	7/8	2 3/4	37.44
15	.1800	7/8	2 3/4	36.90
16	.1770	7/8	2 3/4	36.72
17	.1730	7/8	2 3/4	35.87
18	.1695	7/8	2 3/4	35.24
19	.1660	7/8	2 3/4	34.79
20	.1610	7/8	2 3/4	34.65
21	.1590	3/4	2 1/2	34.16
22	.1570	3/4	2 1/2	33.35
23	.1540	3/4	2 1/2	32.27

Size	Decimal Equivalent	Flute Length	Overall Length	Price Each
24	.1520	3/4	2 1/2	30.96
25	.1495	3/4	2 1/2	30.92
26	.1470	3/4	2 1/2	30.74
27	.1440	3/4	2 1/2	29.93
28	.1405	3/4	2 1/2	28.62
29	.1360	3/4	2 1/2	28.22
30	.1285	3/4	2 1/2	28.22
31	.1200	5/8	2 1/4	28.17
32	.1160	5/8	2 1/4	28.04
33	.1130	5/8	2 1/4	28.04
34	.1110	5/8	2 1/4	27.68
35	.1100	5/8	2 1/4	27.27
36	.1065	5/8	2 1/4	26.42
37	.1040	5/8	2 1/4	27.77
38	.1015	5/8	2 1/4	26.15
39	.0995	5/8	2 1/4	26.15
40	.0980	5/8	2 1/4	25.97
41	.0960	1/2	2	25.97
42	.0935	1/2	2	25.43
43	.0890	1/2	2	25.34
44	.0860	1/2	2	24.89
45	.0820	1/2	2	24.89
46	.0810	1/2	1 3/4	24.75

Solid Carbide Chucking Reamers

List No. **C805**: Straight Shank, Straight Flute
Shank diameter same as cutting diameter



- 4 flutes on sizes up to .255" diameter
- 6 flutes on sizes .255" diameter and above
- Cutting flutes are precision ground
- Close tolerances and consistent tool accuracy.

Number Sizes *Continued*

Size	Decimal Equivalent	Flute Length	Overall Length	Price Each
47	.0785	1/2	1 3/4	24.71
48	.0760	1/2	1 3/4	24.71
49	.0730	1/2	1 3/4	24.71
50	.0700	1/2	1 3/4	24.71
51	.0670	1/2	1 3/4	24.71
52	.0635	3/8	1 1/2	24.42
53	.0595	3/8	1 1/2	23.90
54	.0550	3/8	1 1/2	23.90
55	.0520	3/8	1 1/2	23.90
56	.0465	3/8	1 1/2	23.90
57	.0430	3/8	1 1/2	23.67
58	.0420	3/8	1 1/2	23.67

Size	Decimal Equivalent	Flute Length	Overall Length	Price Each
59	.0410	3/8	1 1/2	23.67
60	.0400	1/4	1 1/2	23.67
61	.0390	1/4	1 1/2	23.67
62	.0380	1/4	1 1/2	23.67
63	.0370	1/4	1 1/2	23.67
64	.0360	1/4	1 1/2	23.67
65	.0350	1/4	1 1/2	23.67
66	.0330	1/4	1 1/2	24.44
67	.0320	1/4	1 1/2	24.44
68	.0310	1/4	1 1/2	25.00
69	.0292	1/4	1 1/2	25.00
70	.0280	1/4	1 1/2	25.00

Metric Sizes

Size	Decimal Equivalent	Flute Length	Overall Length	Price Each
1.00mm	.0394	1/4	1 1/2	21.56
1.25mm	.0492	3/8	1 1/2	25.16
1.50mm	.0591	3/8	1 1/2	21.87
1.60mm	.0630	3/8	1 1/2	25.79
1.65mm	.0650	3/8	1 1/2	25.97
2.00mm	.0787	1/2	1 3/4	22.82
2.40mm	.0945	1/2	2	26.91
2.50mm	.0984	5/8	2 1/4	23.67
3.00mm	.1181	5/8	2 1/4	25.97
3.50mm	.1378	3/4	2 1/2	26.28
4.00mm	.1575	3/4	2 1/2	30.51
4.50mm	.1772	7/8	2 3/4	33.35
5.00mm	.1969	1	3	38.25
5.50mm	.2165	1	3	39.74
6.00mm	.2362	1	3	47.21
6.50mm	.2559	1-1/8	3 1/4	57.15

Size	Decimal Equivalent	Flute Length	Overall Length	Price Each
7.00mm	.2756	1 1/8	3 1/4	52.16
7.50mm	.2953	1 1/8	3 1/4	67.01
8.00mm	.3150	1 1/8	3 1/4	63.81
8.50mm	.3346	1 1/4	3 1/2	85.01
9.00mm	.3543	1 1/4	3 1/2	78.44
9.50mm	.3740	1 1/4	3 1/2	87.75
10.00mm	.3937	1 1/4	3 1/2	100.08
10.50mm	.4134	1 1/4	3 1/2	100.08
11.00mm	.4331	1 3/8	4	112.68
11.50mm	.4528	1 3/8	4	112.68
12.00mm	.4724	1 3/8	4	121.50
12.50mm	.4921	1 1/2	4	121.50
13.00mm	.5118	1 1/2	4	165.00
14.00mm	.5512	1 1/2	4	186.00
15.00mm	.5906	1 1/2	4	186.00
16.00mm	.6299	1 1/2	4	186.00

Decimal Sizes

Diameter	Flute Length	Overall Length	Price Each
.0300	1/4	1 1/2	25.79
.0315	1/4	1 1/2	25.79
.0325	1/4	1 1/2	25.79
.0335	1/4	1 1/2	25.79
.0340	1/4	1 1/2	24.89
.0345	1/4	1 1/2	24.89
.0355	1/4	1 1/2	24.89
.0365	1/4	1 1/2	24.89
.0375	1/4	1 1/2	24.89
.0385	1/4	1 1/2	24.89
.0395	1/4	1 1/2	24.89
.0405	1/4	1 1/2	24.89
.0415	1/4	1 1/2	24.89
.0425	3/8	1 1/2	24.89
.0435	3/8	1 1/2	25.16
.0440	3/8	1 1/2	25.16
.0445	3/8	1 1/2	25.16
.0450	3/8	1 1/2	25.16
.0455	3/8	1 1/2	25.16
.0460	3/8	1 1/2	25.16
.0470	3/8	1 1/2	25.16
.0475	3/8	1 1/2	25.16
.0480	3/8	1 1/2	25.16
.0485	3/8	1 1/2	25.16
.0490	3/8	1 1/2	25.16
.0495	3/8	1 1/2	25.16

Diameter	Flute Length	Overall Length	Price Each
.0500	3/8	1 1/2	25.16
.0505	3/8	1 1/2	25.16
.0510	3/8	1 1/2	25.16
.0515	3/8	1 1/2	25.16
.0525	3/8	1 1/2	25.16
.0530	3/8	1 1/2	25.16
.0535	3/8	1 1/2	25.16
.0540	3/8	1 1/2	25.16
.0545	3/8	1 1/2	25.16
.0555	3/8	1 1/2	25.16
.0560	3/8	1 1/2	25.16
.0565	3/8	1 1/2	25.16
.0570	3/8	1 1/2	25.16
.0575	3/8	1 1/2	25.16
.0580	3/8	1 1/2	25.16
.0585	3/8	1 1/2	25.16
.0590	3/8	1 1/2	25.16
.0600	3/8	1 1/2	25.79
.0605	3/8	1 1/2	25.79
.0610	3/8	1 1/2	25.79
.0615	3/8	1 1/2	25.79
.0620	3/8	1 1/2	25.79
.0630	3/8	1 1/2	25.79
.0640	3/8	1 1/2	25.79
.0645	3/8	1 1/2	25.79
.0650	3/8	1 1/2	25.97

Solid Carbide Chucking Reamers

List No. **C805**: Straight Shank, Straight Flute
 Shank diameter same as cutting diameter



- 4 flutes on sizes up to .255" diameter
- 6 flutes on sizes .255" diameter and above
- Cutting flutes are precision ground
- Close tolerances and consistent tool accuracy.

Decimal Sizes *Continued*

Diameter	Flute Length	Overall Length	Price Each
.0655	1/2	1 3/4	25.97
.0660	1/2	1 3/4	25.97
.0665	1/2	1 3/4	25.97
.0675	1/2	1 3/4	25.97
.0680	1/2	1 3/4	25.97
.0685	1/2	1 3/4	25.97
.0690	1/2	1 3/4	25.97
.0695	1/2	1 3/4	25.97
.0705	1/2	1 3/4	25.97
.0710	1/2	1 3/4	25.97
.0715	1/2	1 3/4	25.97
.0720	1/2	1 3/4	25.97
.0725	1/2	1 3/4	25.97
.0735	1/2	1 3/4	25.97
.0740	1/2	1 3/4	25.97
.0745	1/2	1 3/4	25.97
.0750	1/2	1 3/4	25.97
.0755	1/2	1 3/4	25.97
.0765	1/2	1 3/4	25.97
.0770	1/2	1 3/4	25.97
.0775	1/2	1 3/4	25.97
.0780	1/2	1 3/4	25.97
.0790	1/2	1 3/4	25.97
.0795	1/2	1 3/4	26.15
.0800	1/2	1 3/4	26.15
.0805	1/2	1 3/4	26.15
.0815	1/2	2	26.15
.0825	1/2	2	26.15
.0830	1/2	2	26.15
.0835	1/2	2	26.15
.0840	1/2	2	26.15
.0845	1/2	2	26.15
.0850	1/2	2	26.15
.0855	1/2	2	26.15
.0865	1/2	2	26.15
.0870	1/2	2	26.15
.0875	1/2	2	26.15
.0880	1/2	2	26.15
.0885	1/2	2	26.15
.0895	1/2	2	26.91
.0900	1/2	2	26.91
.0905	1/2	2	26.91
.0910	1/2	2	26.91
.0915	1/2	2	26.91
.0920	1/2	2	26.91
.0925	1/2	2	26.91
.0930	1/2	2	26.91
.0940	1/2	2	26.91
.0945	1/2	2	26.91
.0950	1/2	2	27.27
.0955	1/2	2	27.27
.0965	1/2	2	27.27
.0970	5/8	2 1/4	27.27
.0975	5/8	2 1/4	27.27
.0985	5/8	2 1/4	27.45
.0990	5/8	2 1/4	27.45
.1000	5/8	2 1/4	27.45
.1005	5/8	2 1/4	27.45
.1010	5/8	2 1/4	27.45
.1020	5/8	2 1/4	27.77
.1025	5/8	2 1/4	27.77
.1030	5/8	2 1/4	27.77
.1035	5/8	2 1/4	27.77
.1045	5/8	2 1/4	27.77
.1050	5/8	2 1/4	27.77
.1055	5/8	2 1/4	27.77

Diameter	Flute Length	Overall Length	Price Each
.1060	5/8	2 1/4	27.77
.1070	5/8	2 1/4	28.22
.1075	5/8	2 1/4	28.22
.1080	5/8	2 1/4	28.22
.1085	5/8	2 1/4	28.62
.1090	5/8	2 1/4	28.62
.1095	5/8	2 1/4	28.62
.1105	5/8	2 1/4	28.62
.1115	5/8	2 1/4	29.48
.1120	5/8	2 1/4	29.48
.1125	5/8	2 1/4	29.48
.1135	5/8	2 1/4	29.48
.1140	5/8	2 1/4	29.48
.1145	5/8	2 1/4	29.48
.1150	5/8	2 1/4	29.48
.1155	5/8	2 1/4	29.48
.1165	5/8	2 1/4	29.48
.1170	5/8	2 1/4	29.48
.1175	5/8	2 1/4	29.48
.1180	5/8	2 1/4	29.48
.1185	5/8	2 1/4	29.61
.1190	5/8	2 1/4	29.61
.1195	5/8	2 1/4	29.61
.1205	5/8	2 1/4	29.61
.1210	5/8	2 1/4	29.61
.1215	5/8	2 1/4	29.61
.1220	5/8	2 1/4	29.61
.1225	5/8	2 1/4	29.61
.1230	5/8	2 1/4	29.61
.1235	5/8	2 1/4	29.61
.1240	5/8	2 1/4	29.61
.1245	5/8	2 1/4	29.61
.1247	5/8	2 1/4	29.61
.1255	5/8	2 1/4	29.61
.1260	5/8	2 1/4	29.61
.1265	5/8	2 1/4	29.61
.1270	5/8	2 1/4	29.75
.1275	5/8	2 1/4	29.75
.1280	5/8	2 1/4	29.75
.1290	5/8	2 1/4	29.75
.1295	5/8	2 1/4	29.75
.1300	5/8	2 1/4	29.75
.1305	3/4	2 1/2	29.75
.1310	3/4	2 1/2	29.75
.1315	3/4	2 1/2	29.75
.1320	3/4	2 1/2	29.75
.1325	3/4	2 1/2	29.75
.1330	3/4	2 1/2	29.75
.1335	3/4	2 1/2	29.75
.1340	3/4	2 1/2	29.75
.1345	3/4	2 1/2	29.75
.1350	3/4	2 1/2	29.75
.1355	3/4	2 1/2	29.75
.1365	3/4	2 1/2	29.75
.1370	3/4	2 1/2	29.75
.1375	3/4	2 1/2	29.75
.1380	3/4	2 1/2	30.24
.1385	3/4	2 1/2	30.24
.1390	3/4	2 1/2	30.24
.1395	3/4	2 1/2	30.24
.1400	3/4	2 1/2	30.24
.1410	3/4	2 1/2	31.37
.1415	3/4	2 1/2	31.37
.1420	3/4	2 1/2	31.37
.1425	3/4	2 1/2	31.37
.1430	3/4	2 1/2	31.37

Solid Carbide Chucking Reamers

List No. **C805**: Straight Shank, Straight Flute
Shank diameter same as cutting diameter



- 4 flutes on sizes up to .255" diameter
- 6 flutes on sizes .255" diameter and above
- Cutting flutes are precision ground
- Close tolerances and consistent tool accuracy.

Decimal Sizes *Continued*

Diameter	Flute Length	Overall Length	Price Each
.1435	3/4	2 1/2	31.37
.1445	3/4	2 1/2	31.55
.1450	3/4	2 1/2	31.55
.1455	3/4	2 1/2	31.55
.1460	3/4	2 1/2	32.45
.1465	3/4	2 1/2	31.55
.1475	3/4	2 1/2	31.55
.1480	3/4	2 1/2	32.49
.1485	3/4	2 1/2	32.49
.1490	3/4	2 1/2	32.49
.1500	3/4	2 1/2	32.49
.1505	3/4	2 1/2	32.49
.1507	3/4	2 1/2	32.49
.1510	3/4	2 1/2	32.49
.1515	3/4	2 1/2	32.49
.1525	3/4	2 1/2	33.89
.1530	3/4	2 1/2	33.89
.1535	3/4	2 1/2	33.89
.1541	3/4	2 1/2	33.89
.1545	3/4	2 1/2	33.89
.1550	3/4	2 1/2	33.89
.1555	3/4	2 1/2	33.89
.1560	3/4	2 1/2	33.89
.1565	3/4	2 1/2	35.15
.1580	3/4	2 1/2	35.15
.1585	3/4	2 1/2	35.15
.1595	3/4	2 1/2	36.50
.1600	3/4	2 1/2	36.50
.1605	3/4	2 1/2	36.50
.1615	7/8	2 3/4	36.50
.1620	7/8	2 3/4	36.50
.1625	7/8	2 3/4	36.50
.1630	7/8	2 3/4	36.50
.1635	7/8	2 3/4	36.50
.1640	7/8	2 3/4	36.50
.1645	7/8	2 3/4	36.50
.1650	7/8	2 3/4	36.50
.1655	7/8	2 3/4	36.50
.1665	7/8	2 3/4	36.90
.1670	7/8	2 3/4	36.90
.1675	7/8	2 3/4	36.90
.1680	7/8	2 3/4	36.90
.1685	7/8	2 3/4	36.90
.1690	7/8	2 3/4	36.90
.1700	7/8	2 3/4	37.67
.1705	7/8	2 3/4	37.67
.1710	7/8	2 3/4	37.67
.1715	7/8	2 3/4	37.67
.1720	7/8	2 3/4	37.67
.1725	7/8	2 3/4	37.67
.1735	7/8	2 3/4	38.25
.1740	7/8	2 3/4	38.25
.1745	7/8	2 3/4	38.25
.1750	7/8	2 3/4	38.25
.1755	7/8	2 3/4	38.25
.1760	7/8	2 3/4	38.25
.1765	7/8	2 3/4	38.25
.1775	7/8	2 3/4	38.70
.1780	7/8	2 3/4	38.70
.1785	7/8	2 3/4	38.70
.1790	7/8	2 3/4	38.70
.1795	7/8	2 3/4	38.70
.1805	7/8	2 3/4	38.70
.1810	7/8	2 3/4	38.70
.1814	7/8	2 3/4	38.70
.1815	7/8	2 3/4	38.70

Diameter	Flute Length	Overall Length	Price Each
.1825	7/8	2 3/4	38.70
.1830	7/8	2 3/4	38.70
.1835	7/8	2 3/4	39.65
.1840	7/8	2 3/4	39.65
.1845	7/8	2 3/4	39.65
.1855	7/8	2 3/4	41.72
.1860	7/8	2 3/4	41.72
.1865	7/8	2 3/4	41.72
.1870	7/8	2 3/4	41.72
.1872	7/8	2 3/4	41.72
.1880	7/8	2 3/4	41.72
.1885	7/8	2 3/4	41.72
.1895	7/8	2 3/4	41.72
.1900	7/8	2 3/4	41.72
.1905	7/8	2 3/4	41.72
.1915	7/8	2 3/4	42.35
.1920	1	3	42.35
.1925	1	3	42.35
.1930	1	3	42.35
.1940	1	3	42.35
.1945	1	3	42.35
.1950	1	3	43.92
.1955	1	3	43.92
.1965	1	3	43.92
.1970	1	3	43.92
.1975	1	3	43.92
.1980	1	3	43.92
.1985	1	3	43.92
.1995	1	3	45.68
.2000	1	3	45.68
.2005	1	3	45.68
.2015	1	3	45.68
.2020	1	3	45.68
.2025	1	3	45.68
.2030	1	3	45.68
.2035	1	3	45.68
.2045	1	3	45.68
.2050	1	3	45.68
.2060	1	3	45.68
.2065	1	3	45.68
.2070	1	3	45.68
.2075	1	3	45.68
.2080	1	3	45.68
.2085	1	3	45.68
.2095	1	3	45.68
.2100	1	3	45.68
.2105	1	3	45.68
.2110	1	3	45.68
.2115	1	3	45.68
.2120	1	3	45.68
.2125	1	3	45.68
.2135	1	3	45.68
.2140	1	3	45.68
.2145	1	3	45.68
.2150	1	3	45.68
.2155	1	3	45.68
.2160	1	3	45.68
.2170	1	3	45.68
.2175	1	3	45.68
.2177	1	3	45.68
.2180	1	3	51.08
.2185	1	3	51.08
.2190	1	3	51.08
.2195	1	3	51.08
.2200	1	3	51.08
.2205	1	3	51.08

Solid Carbide Chucking Reamers

List No. **C805**: Straight Shank, Straight Flute
 Shank diameter same as cutting diameter



- 4 flutes on sizes up to .255" diameter
- 6 flutes on sizes .255" diameter and above
- Cutting flutes are precision ground
- Close tolerances and consistent tool accuracy.

Decimal Sizes *Continued*

Diameter	Flute Length	Overall Length	Price Each
.2215	1	3	53.06
.2220	1	3	53.06
.2225	1	3	53.06
.2230	1	3	53.06
.2235	1	3	53.06
.2240	1	3	53.06
.2245	1	3	53.06
.2250	1	3	53.06
.2255	1	3	53.06
.2260	1	3	53.06
.2265	1	3	53.60
.2270	1	3	53.60
.2275	1	3	53.60
.2285	1	3	53.60
.2290	1	3	53.60
.2295	1	3	53.60
.2300	1	3	53.60
.2305	1	3	53.60
.2310	1	3	53.60
.2315	1	3	53.60
.2320	1	3	53.60
.2325	1	3	53.60
.2330	1	3	53.60
.2335	1	3	53.60
.2345	1	3	53.60
.2350	1	3	53.60
.2355	1	3	53.60
.2360	1	3	53.60
.2365	1	3	54.50
.2370	1	3	54.50
.2375	1	3	54.50
.2385	1	3	54.50
.2390	1	3	54.50
.2395	1	3	54.50
.2400	1	3	54.50
.2405	1	3	54.50
.2410	1	3	54.50
.2415	1	3	54.50
.2425	1	3	54.50
.2430	1	3	54.50
.2435	1	3	54.50
.2440	1	3	54.50
.2445	1	3	54.50
.2450	1	3	54.50
.2455	1	3	54.50
.2465	1	3	54.50
.2470	1	3	54.50
.2475	1	3	54.50
.2480	1	3	54.50
.2485	1	3	54.50
.2490	1	3	54.50
.2495	1	3	54.50
.2505	1	3	54.50
.2510	1	3	54.50
.2515	1	3	54.50
.2520	1	3	54.50
.2525	1	3	54.50
.2530	1	3	54.50
.2535	1	3	60.21
.2540	1	3	60.21
.2545	1	3	60.21
.2550	1	3	60.21
.2560	1 1/8	3 1/4	60.21
.2565	1 1/8	3 1/4	60.21
.2575	1 1/8	3 1/4	60.21
.2580	1 1/8	3 1/4	60.21

Diameter	Flute Length	Overall Length	Price Each
.2590	1 1/8	3 1/4	60.21
.2600	1 1/8	3 1/4	60.21
.2620	1 1/8	3 1/4	60.21
.2630	1 1/8	3 1/4	60.21
.2635	1 1/8	3 1/4	60.21
.2640	1 1/8	3 1/4	60.21
.2650	1 1/8	3 1/4	60.21
.2670	1 1/8	3 1/4	60.21
.2680	1 1/8	3 1/4	60.21
.2690	1 1/8	3 1/4	60.21
.2700	1 1/8	3 1/4	60.21
.2710	1 1/8	3 1/4	60.21
.2730	1 1/8	3 1/4	60.21
.2740	1 1/8	3 1/4	60.21
.2750	1 1/8	3 1/4	60.21
.2760	1 1/8	3 1/4	60.21
.2780	1 1/8	3 1/4	65.16
.2790	1 1/8	3 1/4	65.16
.2800	1 1/8	3 1/4	65.16
.2818	1 1/8	3 1/4	65.16
.2820	1 1/8	3 1/4	70.52
.2830	1 1/8	3 1/4	70.52
.2840	1 1/8	3 1/4	70.52
.2850	1 1/8	3 1/4	70.52
.2860	1 1/8	3 1/4	70.52
.2870	1 1/8	3 1/4	70.52
.2880	1 1/8	3 1/4	70.52
.2890	1 1/8	3 1/4	70.52
.2910	1 1/8	3 1/4	70.52
.2920	1 1/8	3 1/4	70.52
.2930	1 1/8	3 1/4	70.52
.2940	1 1/8	3 1/4	70.52
.2960	1 1/8	3 1/4	70.52
.2970	1 1/8	3 1/4	73.35
.2980	1 1/8	3 1/4	73.35
.2990	1 1/8	3 1/4	73.35
.3000	1 1/8	3 1/4	73.35
.3010	1 1/8	3 1/4	73.35
.3030	1 1/8	3 1/4	73.35
.3040	1 1/8	3 1/4	73.35
.3050	1 1/8	3 1/4	73.35
.3060	1 1/8	3 1/4	73.35
.3070	1 1/8	3 1/4	73.35
.3080	1 1/8	3 1/4	73.35
.3090	1 1/8	3 1/4	73.35
.3100	1 1/8	3 1/4	73.35
.3105	1 1/8	3 1/4	73.35
.3110	1 1/8	3 1/4	73.35
.3115	1 1/8	3 1/4	73.35
.3120	1 1/8	3 1/4	73.35
.3130	1 1/8	3 1/4	73.35
.3135	1 1/8	3 1/4	73.35
.3140	1 1/8	3 1/4	73.35
.3170	1 1/4	3 1/2	78.12
.3180	1 1/4	3 1/2	78.12
.3190	1 1/4	3 1/2	78.12
.3200	1 1/4	3 1/2	78.12
.3210	1 1/4	3 1/2	78.12
.3220	1 1/4	3 1/2	78.12
.3240	1 1/4	3 1/2	89.46
.3250	1 1/4	3 1/2	89.46
.3260	1 1/4	3 1/2	89.46
.3270	1 1/4	3 1/2	89.46
.3280	1 1/4	3 1/2	89.46
.3290	1 1/4	3 1/2	89.46
.3300	1 1/4	3 1/2	89.46

Solid Carbide Chucking Reamers

List No. **C805**: Straight Shank, Straight Flute
Shank diameter same as cutting diameter



- 4 flutes on sizes up to .255" diameter
- 6 flutes on sizes .255" diameter and above
- Cutting flutes are precision ground
- Close tolerances and consistent tool accuracy.

Decimal Sizes *Continued*

Diameter	Flute Length	Overall Length	Price Each
.3310	1 1/4	3 1/2	89.46
.3330	1 1/4	3 1/2	89.46
.3340	1 1/4	3 1/2	89.46
.3350	1 1/4	3 1/2	89.46
.3360	1 1/4	3 1/2	89.46
.3370	1 1/4	3 1/2	89.46
.3380	1 1/4	3 1/2	89.46
.3400	1 1/4	3 1/2	89.46
.3410	1 1/4	3 1/2	89.46
.3420	1 1/4	3 1/2	89.46
.3430	1 1/4	3 1/2	89.46
.3440	1 1/4	3 1/2	89.46
.3450	1 1/4	3 1/2	89.46
.3460	1 1/4	3 1/2	89.46
.3470	1 1/4	3 1/2	89.46
.3490	1 1/4	3 1/2	89.46
.3500	1 1/4	3 1/2	89.46
.3510	1 1/4	3 1/2	89.46
.3520	1 1/4	3 1/2	89.46
.3530	1 1/4	3 1/2	89.46
.3540	1 1/4	3 1/2	89.46
.3550	1 1/4	3 1/2	90.09
.3560	1 1/4	3 1/2	90.09
.3570	1 1/4	3 1/2	90.09
.3590	1 1/4	3 1/2	90.09
.3600	1 1/4	3 1/2	91.80
.3610	1 1/4	3 1/2	91.80
.3620	1 1/4	3 1/2	91.80
.3630	1 1/4	3 1/2	91.80
.3640	1 1/4	3 1/2	91.80
.3650	1 1/4	3 1/2	91.80
.3660	1 1/4	3 1/2	91.80
.3670	1 1/4	3 1/2	91.80
.3690	1 1/4	3 1/2	91.80
.3700	1 1/4	3 1/2	91.80
.3710	1 1/4	3 1/2	91.80
.3720	1 1/4	3 1/2	91.80
.3730	1 1/4	3 1/2	91.80
.3745	1 1/4	3 1/2	91.80
.3755	1 1/4	3 1/2	109.76
.3760	1 1/4	3 1/2	109.76
.3765	1 1/4	3 1/2	109.76
.3780	1 1/4	3 1/2	109.76
.3790	1 1/4	3 1/2	109.76
.3800	1 1/4	3 1/2	109.76
.3810	1 1/4	3 1/2	109.76
.3820	1 1/4	3 1/2	109.76
.3830	1 1/4	3 1/2	109.76
.3840	1 1/4	3 1/2	109.76
.3850	1 1/4	3 1/2	109.76
.3870	1 1/4	3 1/2	115.43
.3880	1 1/4	3 1/2	115.43
.3890	1 1/4	3 1/2	115.43
.3900	1 1/4	3 1/2	115.43
.3910	1 1/4	3 1/2	115.43
.3920	1 1/4	3 1/2	115.43
.3930	1 1/4	3 1/2	115.43
.3940	1 1/4	3 1/2	115.43
.3950	1 1/4	3 1/2	115.43
.3960	1 1/4	3 1/2	115.43
.3980	1 1/4	3 1/2	115.43
.3990	1 1/4	3 1/2	115.43
.4000	1 1/4	3 1/2	115.43
.4010	1 1/4	3 1/2	115.43
.4020	1 1/4	3 1/2	115.43
.4030	1 1/4	3 1/2	115.43

Diameter	Flute Length	Overall Length	Price Each
.4050	1 1/4	3 1/2	115.43
.4060	1 1/4	3 1/2	115.43
.4070	1 1/4	3 1/2	115.43
.4080	1 1/4	3 1/2	115.43
.4090	1 1/4	3 1/2	115.43
.4100	1 1/4	3 1/2	115.43
.4110	1 1/4	3 1/2	115.43
.4120	1 1/4	3 1/2	115.43
.4140	1 1/4	3 1/2	118.49
.4150	1 1/4	3 1/2	118.49
.4160	1 1/4	3 1/2	118.49
.4170	1 3/8	4	118.49
.4180	1 3/8	4	118.49
.4190	1 3/8	4	118.49
.4200	1 3/8	4	118.49
.4210	1 3/8	4	118.49
.4230	1 3/8	4	118.49
.4240	1 3/8	4	118.49
.4250	1 3/8	4	118.49
.4260	1 3/8	4	118.49
.4270	1 3/8	4	118.49
.4280	1 3/8	4	118.49
.4290	1 3/8	4	118.49
.4300	1 3/8	4	118.49
.4310	1 3/8	4	118.49
.4320	1 3/8	4	118.49
.4330	1 3/8	4	118.49
.4340	1 3/8	4	118.49
.4350	1 3/8	4	118.49
.4355	1 3/8	4	118.49
.4360	1 3/8	4	118.49
.4365	1 3/8	4	118.49
.4370	1 3/8	4	118.49
.4380	1 3/8	4	129.78
.4385	1 3/8	4	129.78
.4390	1 3/8	4	129.78
.4400	1 3/8	4	129.78
.4410	1 3/8	4	129.78
.4420	1 3/8	4	129.78
.4430	1 3/8	4	129.78
.4440	1 3/8	4	129.78
.4450	1 3/8	4	129.78
.4460	1 3/8	4	129.78
.4470	1 3/8	4	129.78
.4480	1 3/8	4	129.78
.4490	1 3/8	4	129.78
.4500	1 3/8	4	129.78
.4510	1 3/8	4	129.78
.4520	1 3/8	4	129.78
.4530	1 3/8	4	129.78
.4540	1 3/8	4	129.78
.4550	1 3/8	4	129.78
.4560	1 3/8	4	129.78
.4570	1 3/8	4	129.78
.4580	1 3/8	4	129.78
.4590	1 3/8	4	129.78
.4600	1 3/8	4	129.78
.4610	1 3/8	4	129.78
.4620	1 3/8	4	129.78
.4630	1 3/8	4	129.78
.4640	1 3/8	4	129.78
.4650	1 3/8	4	129.78
.4660	1 3/8	4	129.78
.4670	1 3/8	4	129.78
.4680	1 3/8	4	129.78
.4690	1 3/8	4	129.78

Solid Carbide Chucking Reamers

List No. **C805**: Straight Shank, Straight Flute
Shank diameter same as cutting diameter



- 4 flutes on sizes up to .255" diameter
- 6 flutes on sizes .255" diameter and above
- Cutting flutes are precision ground
- Close tolerances and consistent tool accuracy.

Decimal Sizes *Continued*

Diameter	Flute Length	Overall Length	Price Each
.4700	1 3/8	4	129.78
.4710	1 3/8	4	129.78
.4720	1 3/8	4	129.78
.4730	1 3/8	4	141.17
.4740	1 3/8	4	141.17
.4750	1 3/8	4	141.17
.4760	1 3/8	4	141.17
.4770	1 3/8	4	141.17
.4780	1 3/8	4	141.17
.4790	1 1/2	4	141.17
.4800	1 1/2	4	141.17
.4805	1 1/2	4	141.17
.4810	1 1/2	4	141.17
.4820	1 1/2	4	141.17
.4830	1 1/2	4	141.17
.4840	1 1/2	4	141.17
.4850	1 1/2	4	141.17
.4860	1 1/2	4	141.17
.4870	1 1/2	4	141.17

Diameter	Flute Length	Overall Length	Price Each
.4880	1 1/2	4	141.17
.4890	1 1/2	4	141.17
.4900	1 1/2	4	141.17
.4910	1 1/2	4	141.17
.4930	1 1/2	4	141.17
.4940	1 1/2	4	141.17
.4950	1 1/2	4	141.17
.4960	1 1/2	4	141.17
.4970	1 1/2	4	141.17
.4980	1 1/2	4	141.17
.4990	1 1/2	4	141.17
.4995	1 1/2	4	141.17
.5005	1 1/2	4	141.17
.5010	1 1/2	4	141.17
.5015	1 1/2	4	141.17
.5020	1 1/2	4	141.17
.5030	1 1/2	4	141.17
.5040	1 1/2	4	141.17
.5050	1 1/2	4	141.17

Carbide-Tipped Chucking Reamers

List No. **CT550**: Straight Shank, Straight Flute

List No. **CT551**: Straight Shank, Right Hand Spiral, Right Hand Cut



For hole reaming in cast iron, heat-treated steels and other hard metals.

Specifications				Price Each	
Diameter	Decimal Equivalent	Flute Length	Overall Length	CT550 Straight Flute	CT551 RH Spiral RH Cut
3/16	.1875	1 1/8	4 1/2	55.58	62.50
13/64	.2031	1 1/4	5	55.58	—
7/32	.2188	1 1/4	5	55.58	62.50
15/64	.2344	1 1/2	6	55.58	62.50
1/4	.2500	1 1/2	6	55.58	62.50
17/64	.2656	1 1/2	6	56.90	—
9/32	.2812	1 1/2	6	56.90	62.50
19/64	.2969	1 1/2	6	56.90	—
5/16	.3125	1 1/2	6	56.90	62.50
21/64	.3281	1 1/2	6	58.89	—
11/32	.3438	1 1/2	6	58.89	67.00
23/64	.3594	1 3/4	7	58.95	—
3/8	.3750	1 3/4	7	58.95	67.00
25/64	.3906	1 3/4	7	61.65	—
13/32	.4062	1 3/4	7	61.65	69.00
27/64	.4219	1 3/4	7	65.72	—
7/16	.4375	1 3/4	7	65.72	69.00
29/64	.4531	1 3/4	7	66.95	—
15/32	.4688	1 3/4	7	66.95	74.80
31/64	.4844	2	8	72.25	—
1/2	.5000	2	8	72.36	79.90
17/32	.5312	2	8	74.25	82.00
35/64	.5469	2	8	76.50	—
9/16	.5625	2	8	74.34	83.00

Specifications				Price Each	
Diameter	Decimal Equivalent	Flute Length	Overall Length	CT550 Straight Flute	CT551 RH Spiral RH Cut
19/32	.5938	2	8	77.10	85.00
5/8	.6250	2 1/4	9	77.20	85.00
21/32	.6562	2 1/4	9	78.55	85.00
11/16	.6875	2 1/4	9	78.55	89.50
23/32	.7188	2 1/4	9	82.20	92.00
3/4	.7500	2 1/2	9 1/2	82.20	92.00
25/32	.7812	2 1/2	9 1/2	84.00	—
13/16	.8125	2 1/2	9 1/2	84.95	94.50
27/32	.8438	2 1/2	9 1/2	88.27	112.70
7/8	.8750	2 5/8	10	88.27	97.70
29/32	.9062	2 5/8	10	99.90	112.70
15/16	.9375	2 5/8	10	102.95	112.70
31/32	.9688	2 5/8	10	105.25	117.90
1	1.0000	2 3/4	10 1/2	107.94	114.00
1 1/16	1.0625	2 3/4	10 1/2	116.24	119.00
1 3/32	1.0938	2 7/8	11	123.77	—
1 1/8	1.1250	2 7/8	11	125.83	135.00
1 3/16	1.1875	2 7/8	11	132.25	140.00
1 1/4	1.2500	3	11 1/2	139.66	145.00
1 5/16	1.3125	3	11 1/2	147.18	153.00
1 3/8	1.3750	3 1/4	12	156.00	162.00
1 7/16	1.4375	3 1/4	12	177.00	—
1 1/2	1.5000	3 1/2	12 1/2	182.60	195.00

DROLER® Combination Drill & Reamer High Speed Steel



List No. **LV524**: Jobber Length

Drill and ream in one easy operation. Drill lengths are 2X the reaming diameter.

Size	Decimal Equivalent	Pilot Size	Flute Length	Overall Length	Price Each
1/8	.1250	.1153	2	3 1/8	45.82
5/32	.1562	.1457	2 1/2	3 3/4	47.88
3/16	.1875	.1764	2 1/2	3 3/4	46.68
7/32	.2188	.2071	2 3/4	4	50.44
1/4	.2500	.2379	2 15/16	4 1/8	50.81
9/32	.2812	.2687	3 3/16	4 1/2	54.68
5/16	.3125	.2997	3 7/16	4 3/4	56.16
11/32	.3438	.3305	3 5/8	5	65.45
3/8	.3750	.3615	3 7/8	5 1/4	71.00
7/16	.4375	.4235	4 1/2	6	80.56
1/2	.5000	.4856	4 3/16	6 5/8	97.10
9/16	.5625	.5477	4 13/16	6 5/8	111.50
5/8	.6250	.6098	5 3/16	7 1/8	149.90

CNC Stub Screw Machine Reamers High Speed Steel

List No. **554U**: Left Hand Spiral, Right Hand Cut

These short machine reamers are designed particularly for use in screw machine work. They are finished with approximately 7° left hand spiral, right hand cut. Pin holes through the shank allows them to be used in pin drive floating holders.

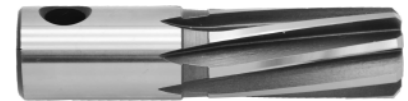

Please indicate decimal size when ordering.

Specifications							Price Each							
Series No.	Finished Dia. Range	Overall Length	Length of Flute	Shank Dia.	Hole Dia.	No. of Flutes	1	2	3 - 5	6 - 11	12 - 23	24 - 35	36 - 40	41+
3	.0961 - .1260	2	3/4	1/8	1/16	4	71.44	52.12	35.01	26.56	24.84	21.06	18.46	16.50
4	.1261 - .1580	2 1/4	1	1/4	3/32	4	71.44	52.12	35.01	26.56	24.84	21.06	18.46	16.50
5	.1581 - .1880	2 1/4	1	1/4	3/32	4	71.44	52.12	35.01	26.56	24.84	21.06	18.46	16.50
6	.1881 - .2190	2 1/4	1	1/4	3/32	6	71.44	52.12	35.01	26.56	24.84	21.06	18.46	16.50
7	.2191 - .2510	2 1/4	1	1/4	3/32	6	71.44	52.12	35.01	26.56	24.84	21.06	18.46	16.50
8	.2511 - .2820	2 1/4	1	3/8	1/8	6	74.59	54.41	37.21	28.15	26.79	22.91	20.31	18.36
9	.2821 - .3130	2 1/4	1	3/8	1/8	6	74.59	54.41	37.21	28.15	26.79	22.91	20.31	18.36
10	.3131 - .3440	2 1/2	1 1/4	3/8	1/8	6	74.59	54.41	37.21	28.15	26.79	22.91	20.31	18.36
11	.3441 - .3760	2 1/2	1 1/4	3/8	1/8	6	74.59	54.41	37.21	28.15	26.79	22.91	20.31	18.36
12	.3761 - .4070	2 1/2	1 1/4	1/2	3/16	6	78.79	57.47	40.31	30.81	29.37	25.65	23.05	21.00
13	.4071 - .4390	2 1/2	1 1/4	1/2	3/16	6	78.79	57.47	40.31	30.81	29.37	25.65	23.05	21.00
14	.4391 - .4700	2 1/2	1 1/4	1/2	3/16	6	78.79	57.47	40.31	30.81	29.37	25.65	23.05	21.00
15	.4701 - .5050	2 1/2	1 1/4	1/2	3/16	6	78.79	57.47	40.31	30.81	29.37	25.65	23.05	21.00
16	.5051 - .5670	3	1 1/2	5/8	1/4	6	81.08	59.15	44.11	34.66	33.68	29.09	26.49	24.34
17	.5671 - .6300	3	1 1/2	5/8	1/4	6	81.08	59.15	44.11	34.66	33.68	29.09	26.49	24.34
18	.6301 - .6920	3	1 1/2	5/8	1/4	6	84.47	61.62	48.13	38.52	34.79	33.87	31.27	27.76
19	.6921 - .7550	3	1 1/2	3/4	5/16	8	86.48	63.09	50.61	41.02	35.09	34.75	32.15	29.84
20	.7551 - .8170	3	1 1/2	3/4	5/16	8	90.54	66.05	55.20	45.42	41.20	38.77	36.17	33.85
21	.8171 - .8800	3	1 1/2	3/4	5/16	8	91.10	66.44	55.81	46.06	39.92	39.27	36.67	34.24
22	.8801 - .9420	3	1 1/2	3/4	5/16	8	96.78	70.62	60.40	50.54	44.21	43.33	40.73	38.10
23	.9421 - 1.0100	3	1 1/2	3/4	5/16	8	102.13	74.50	64.03	54.05	47.66	46.55	43.95	41.30

Other sizes are available upon request.

HUOT® Reamer Index

Description	Pieces Per Set	Case No.	Price Each
Fractional	1/16 — 1/2 by 64ths	29	CZ129 32.50
Letter	A — Z	26	CZ126 32.50
Wire Gauge	1 — 60	60	CZ160 39.00
Over and Under	.1240 — .5010	14	CZ112 32.50
Dowel Pin	.1230 — .4995	14	CZ114 32.50
Metric	1.0mm — 13.0 mm by .5mm	25	CZ125 43.68

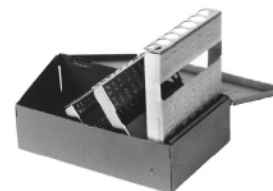

Hand Reamers - Straight Shank High Speed Steel



List No. **564U**: Straight Flute

List No. **565U**: Left Hand Spiral, Right Hand Cut

These reamers are used for the final sizing of holes. The starting taper provides easy entry of the reamer into the holes. They are generally driven by a tap wrench or vise depending upon whether the work or the reamer is rotating.

Specifications				Price Each	
Diameter	Decimal Equivalent	Flute Length	Overall Length	564U Straight Flute	565U LH. SP. RH. Cut
1/16	.0625	1	2	39.00	43.30
5/64	.0781	1	2	39.00	43.30
3/32	.0938	1 1/4	2 1/2	39.00	43.30
7/64	.1094	1 1/4	2 1/2	39.00	43.30
1/8	.1250	1 1/2	3	34.41	39.90
9/64	.1406	1 5/8	3 1/4	34.41	39.90
5/32	.1562	1 5/8	3 1/4	36.20	42.10
#19	.1660	1 3/4	3 1/2	42.00	—
11/64	.1719	1 3/4	3 1/2	36.20	42.10
# 13	.1850	1 3/4	3 1/2	49.00	—
Under 3/16	.1865	1 3/4	3 1/2	42.00	—
3/16	.1875	1 3/4	3 1/2	36.20	40.39
# 8	.1990	1 3/4	3 1/2	51.00	59.00
13/64	.2031	1 7/8	3 3/4	36.20	44.50
7/32	.2188	1 7/8	3 3/4	39.50	44.50
15/64	.2344	2	4	39.50	44.50
1/4	.2500	2	4	39.50	44.50
17/64	.2656	2 1/8	4 1/4	39.50	46.00
9/32	.2812	2 1/8	4 1/4	43.10	49.80
19/64	.2969	2 1/4	4 1/2	43.10	49.80
5/16	.3125	2 1/4	4 1/2	43.10	49.80
21/64	.3281	2 3/8	4 3/4	48.00	53.00
11/32	.3438	2 3/8	4 3/4	48.00	56.00
S	.3480	2 1/2	5	58.00	—
T	.3580	2 1/2	5	58.00	—
23/64	.3594	2 1/2	5	49.00	58.00
Under 3/8	.3745	2 1/2	5	58.00	—
3/8	.3750	2 1/2	5	49.00	58.00
25/64	.3906	2 5/8	5 1/4	56.05	66.40
13/32	.4062	2 5/8	5 1/4	56.05	66.40
27/64	.4219	2 3/4	5 1/2	58.00	69.00
Under 7/16	.4365	2 3/4	5 1/2	—	72.00
7/16	.4375	2 3/4	5 1/2	58.00	66.40
29/64	.4531	2 7/8	5 3/4	61.89	69.00
15/32	.4688	2 7/8	5 3/4	61.89	69.00
31/64	.4844	3	6	62.60	69.00
Under 1/2	.4995	3	6	69.00	—
1/2	.5000	3	6	62.60	69.00
33/64	.5156	3 1/8	6 1/4	69.00	78.00
17/32	.5312	3 1/8	6 1/4	64.00	73.70
35/64	.5469	3 1/4	6 1/2	72.50	84.45
Under 9/16	.5615	3 1/4	6 1/2	—	84.45
9/16	.5625	3 1/4	6 1/2	66.00	74.19
37/64	.5781	3 3/8	6 3/4	81.70	91.66
19/32	.5938	3 3/8	6 3/4	72.30	84.45
39/64	.6094	3 1/2	7	89.00	91.66
Under 5/8	.6240	3 1/2	7	89.00	91.66
5/8	.6250	3 1/2	7	72.50	82.70
41/64	.6406	3 11/16	7 3/8	89.00	99.90
21/32	.6562	3 7/8	7 3/4	80.98	92.30
43/64	.6719	3 7/8	7 3/4	89.00	99.90
11/16	.6875	3 7/8	7 3/4	80.98	92.30
45/64	.7031	4 1/16	8 1/8	98.40	110.60
23/32	.7188	4 1/16	8 1/8	92.40	99.65
47/64	.7344	4 3/16	8 3/8	99.75	111.90
3/4	.7500	4 3/16	8 3/8	92.40	99.65
49/64	.7656	4 3/16	8 3/8	102.00	115.08
25/32	.7812	4 3/16	8 1/2	95.96	105.53

Hand Reamers - Straight Shank High Speed Steel



List No. **564U**: Straight Flute

List No. **565U**: Left Hand Spiral, Right Hand Cut

These reamers are used for the final sizing of holes. The starting taper provides easy entry of the reamer into the holes. They are generally driven by a tap wrench or vise depending upon whether the work or the reamer is rotating.

Specifications				Price Each	
Diameter	Decimal Equivalent	Flute Length	Overall Length	564U Straight Flute	565U LH. SP. RH. Cut
51/64	.7969	4 3/8	8 3/4	85.96	127.59
13/16	.8125	4 9/16	9 1/8	98.26	105.53
53/64	.8281	4 9/16	9 1/8	115.25	127.59
27/32	.8438	4 7/8	9 3/8	102.10	114.56
55/64	.8594	4 7/8	9 3/8	114.25	127.59
7/8	.8750	4 7/8	9 3/4	102.10	114.56
57/64	.8906	4 7/8	10	119.20	136.39
29/32	.9062	4 7/8	10	104.94	127.80
59/64	.9219	5	10	120.35	136.39
15/16	.9375	5 1/8	10 1/4	104.94	127.80
61/64	.9531	5 5/16	10 5/8	—	148.17
31/32	.9688	5 5/16	10 5/8	120.30	136.22
63/64	.9844	5 7/16	10 7/8	—	150.15
1	1.0000	5 7/16	10 7/8	122.90	136.22
1 1/64	1.0156	5 7/16	10 7/8	—	180.00
1 1/32	1.0312	5 7/16	10 7/8	160.00	180.00
1 3/64	1.0469	5 7/16	10 7/8	170.00	190.00
1 1/16	1.0625	5 5/8	11 1/4	146.50	165.00
1 5/64	1.0781	5 5/8	11 1/4	184.00	195.00
1 3/32	1.0938	5 5/8	11 1/4	184.00	195.00
1 7/64	1.1094	5 5/8	11 1/4	—	210.00
1 1/8	1.1250	5 13/16	11 5/8	159.20	180.60
1 9/64	1.1406	5 13/16	11 5/8	215.00	247.00
1 5/32	1.1562	5 13/16	12	215.00	255.00
1 11/64	1.1719	5 13/16	12	—	264.00
1 3/16	1.1875	6	12	189.00	225.00
1 13/64	1.2031	6	12	236.00	269.50
1 7/32	1.2188	6	12	236.00	—
1 15/64	1.2344	6	12	—	269.50
1 1/4	1.2500	6 1/8	12 1/4	195.50	240.00
1 9/32	1.2812	6 1/4	12 1/2	260.00	300.00
1 5/16	1.3125	6 1/4	12 1/2	233.00	249.00
1 11/32	1.3438	6 5/16	12 5/8	267.00	312.00
1 3/8	1.3750	6 5/16	12 5/8	235.00	265.00
1 13/32	1.4062	6 7/16	12 7/8	280.00	—
1 7/16	1.4375	6 7/16	12 7/8	255.00	299.00
1 15/32	1.4688	6 1/2	13	315.00	370.00
1 1/2	1.5000	6 1/2	13	270.00	313.00
1 9/16	1.5625	6 1/2	13	340.00	350.00
1 11/16	1.6875	6 3/4	13 1/2	379.00	395.00
1 23/32	1.7188	6 3/4	13 1/2	598.00	—
1 3/4	1.7500	6 3/4	13 1/2	598.00	625.00
1 13/16	1.8125	7	13 3/4	650.00	—
1 7/8	1.8750	7	14	720.00	—
1 15/16	1.9375	7	14	740.00	—
2	2.0000	7	14	786.00	820.00
2 1/16	2.0625	7 1/2	14 7/8	825.00	—
2 1/8	2.1250	7 1/4	14 1/2	900.00	—
2 3/16	2.1875	7 1/2	15	930.00	—
2 1/4	2.2500	7 1/2	15	945.00	—
2 3/8	2.3750	7 7/8	15	970.00	—
2 9/16	2.5625	7 7/8	15 1/2	1100.00	—
2 11/16	2.6875	8	16	1175.00	—
2 3/4	2.7500	8	16	1200.00	—
2 13/16	2.8125	8 1/4	16 5/8	1350.00	—
3	3.0000	8 1/4	16 5/8	1500.00	—

Metric Hand Reamers - Straight Shank High Speed Steel



List No. **564MU**: Straight Flute

These reamers are used for the final sizing of holes. The starting taper provides easy entry of the reamer into the holes. They are generally driven by a tap wrench or vise depending upon whether the work or the reamer is rotating.

Diameter	Decimal Equivalent	Flute Length	Overall Length	Price Each
3.00	.1181	1 7/32	2 7/16	49.00
3.20	.1260	1 1/4	2 1/2	49.00
3.50	.1378	1 3/8	2 3/4	49.00
4.00	.1575	1 1/2	3	49.00
4.50	.1772	1 5/8	3 1/4	49.00
5.00	.1969	1 3/4	3 1/2	50.82
5.50	.2165	1 13/16	3 5/8	50.82
6.00	.2362	1 13/16	3 5/8	50.82
7.00	.2756	2 1/16	4 3/8	54.45
7.50	.2953	2 1/16	4 3/8	60.50
7.90	.3110	2 1/4	4 1/2	69.00
8.00	.3150	2 1/4	4 1/2	63.64
9.00	.3543	2 7/16	4 7/8	63.64
9.50	.3740	2 7/16	4 7/8	64.00

Diameter	Decimal Equivalent	Flute Length	Overall Length	Price Each
10.00	.3937	2 5/8	5 1/4	70.00
11.00	.4331	2 3/4	5 1/2	70.00
11.50	.4528	2 3/4	5 1/2	75.00
12.00	.4724	3	6	78.00
13.00	.5118	3	6	84.43
14.00	.5512	3 1/4	6 1/2	89.00
15.00	.5906	3 1/4	6 1/2	96.75
16.00	.6299	3 1/2	6 7/8	105.93
17.00	.6693	3 1/2	6 7/8	107.00
17.50	.6890	3 11/16	7 1/2	110.90
18.00	.7087	3 11/16	7 1/2	115.50
19.00	.7480	3 11/16	7 1/2	129.42
20.00	.7874	4	8	129.42

Adjustable Hand Reamers

List No. **570U**: High Speed Steel

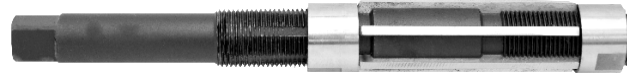

Blades are adjusted by loosening one nut and tightening the other. Each reamer expands to the next size.

Size	Range of Adjustment	Blade Length	Overall Length	Price Each
8/A	1/4 - 9/32	1 11/32	3 1/4	64.81
7/A	9/32 - 5/16	1 11/32	3 1/2	64.81
6/A	5/16 - 11/32	1 1/2	4 1/8	64.81
5/A	11/32 - 3/8	1 1/2	4 3/8	64.81
4/A	3/8 - 13/32	1 1/2	4 3/4	66.99
3/A	13/32 - 7/16	1 1/2	5	74.14
2/A	7/16 - 15/32	1 5/8	5 1/4	74.14
A	15/32 - 17/32	1 5/8	5 1/2	78.58
B	17/32 - 19/32	1 13/16	5 3/4	78.58
C	19/32 - 21/32	2 1/16	6 1/2	81.76
D	21/32 - 23/32	2 3/16	6 3/4	85.59
E	23/32 - 25/32	2 1/2	7	90.11
F	25/32 - 27/32	2 5/8	7 3/8	93.01
G	27/32 - 15/16	3	8	97.64
H	15/16 - 1 1/16	3 1/4	9	103.00
I	1 1/16 - 1 3/16	3 3/8	10	125.79
J	1 3/16 - 1 11/32	3 7/8	11	148.94
K	1 11/32 - 1 1/2	4 1/4	12	193.47
L	1 1/2 - 1 13/16	4 7/16	14	235.84
M	1 13/16 - 2 7/32	5	16	299.39
N	2 7/32 - 2 3/4	5	18	527.32
O	2 3/4 - 3 11/32	5 3/16	20	725.12

Note: Can also be used for reaming pinions.

Sets - Adjustable Hand Reamers

Sizes	No. of Pieces	Part No.	Price
8/A - 5/A	4	570UB	259.24
A - H	8	570UA	708.27
A - K	11	570UC	1176.47



Supplied in Wood Case

Expansion Hand Reamers High Speed Steel

List No. **576U**: Straight Flute

List No. **577U**: Left Hand Spiral, Right Hand Cut



These reamers are used to enlarge holes by a few thousandths. The pilots and guides of these reamers are ground under size to allow smooth entrance.

Recommended Expansion Limits:			
Sizes 1/4 to 21/32	.010"	Sizes 1-1/16 to 1-1/2	.015"
Sizes 11/16 to 1	.013"	Sizes 1-9/16 to 2	.017"

Specifications				Price Each	
Diameter	Decimal Equivalent	Flute Length	Overall Length	576U Straight Flute	577U LH. Sp. RH. Cut
3/16	.1875	1 1/8	3 3/8	148.00	175.00
7/32	.2188	1 3/16	3 1/2	150.00	170.00
1/4	.2500	1 7/16	4 1/2	154.00	180.00
9/32	.2812	1 3/4	4	167.00	183.00
5/16	.3125	1 3/4	4 1/2	165.00	185.00
11/32	.3438	1 3/4	4 1/2	167.00	187.00
9mm	.3543	1 3/4	4 1/2	190.00	—
3/8	.3750	1 3/4	5	169.00	189.00
13/32	.4062	1 3/4	5	180.00	205.00
7/16	.4375	1 3/4	5	184.00	210.00
15/32	.4688	1 13/16	5 1/2	190.00	213.00
1/2	.5000	1 13/16	5 1/2	193.00	216.00
17/32	.5312	2 1/8	6	195.00	218.00
9/16	.5625	2 1/8	6	199.00	221.00
19/32	.5938	2 1/2	6	202.00	228.00
5/8	.6250	2 1/2	6 1/2	205.00	230.00
21/32	.6562	2 1/2	6 1/2	212.00	225.00
11/16	.6875	2 1/2	6 3/4	220.00	240.00
23/32	.7188	2 11/16	6 9/16	233.00	260.00
3/4	.7500	2 11/16	7 1/16	240.00	270.00
25/32	.7812	3 1/16	7 1/16	266.00	300.00
13/16	.8125	3 1/16	7 9/16	279.00	310.00
21mm	.8268	3 1/16	7 9/16	315.00	—
27/32	.8438	3 5/16	7 1/2	288.00	315.00
7/8	.8750	3 5/16	8	290.00	320.00
57/64	.8906	3 5/16	8	313.00	330.00
29/32	.9062	3 9/16	8 3/8	313.00	330.00
59/64	.9219	3 9/16	8 3/8	322.00	340.00
15/16	.9375	3 9/16	8 3/8	322.00	340.00
61/64	.9531	3 9/16	8 3/8	350.00	375.00
31/32	.9688	3 3/4	8 3/8	350.00	375.00
1	1.0000	3 3/4	8 7/8	360.00	385.00
1 1/32	1.0312	4	9 3/16	379.00	—
1 1/16	1.0625	4	9 3/16	388.00	405.00
1 3/32	1.0938	4 1/8	9	396.00	415.00
1 1/8	1.1250	4 1/8	9 1/2	400.00	425.00
29mm	1.1417	4 1/8	9 1/2	425.00	—
1 5/32	1.1562	4 1/4	9 3/8	418.00	435.00
1 3/16	1.1875	4 1/4	9 7/8	411.00	440.00
1 7/32	1.2188	4 3/8	10 1/4	420.00	450.00
31mm	1.2205	4 3/8	10 1/4	450.00	—
1 1/4	1.2500	4 3/8	10 1/4	425.00	460.00

Specifications				Price Each	
Diameter	Decimal Equivalent	Flute Length	Overall Length	576U Straight Flute	577U LH. Sp. RH. Cut
1 9/32	1.2812	4 1/2	10 1/4	439.00	470.00
33mm	1.2992	4 1/2	10 1/4	480.00	—
1 5/16	1.3125	4 1/2	10 5/8	440.00	475.00
1 11/32	1.3438	4 9/16	11	479.00	507.00
1 3/8	1.3750	4 9/16	11	490.00	530.00
1 13/32	1.4062	4 3/4	11 3/8	555.00	615.00
1 7/16	1.4375	4 3/4	11 3/8	570.00	630.00
37mm	1.4567	4 3/4	11 3/8	650.00	—
1 15/32	1.4688	4 13/16	11 5/8	625.00	660.00
1 1/2	1.5000	4 13/16	11 5/8	625.00	685.00
39mm	1.5354	4 13/16	11 5/8	680.00	—
1 9/16	1.5625	4 13/16	11 5/8	660.00	690.00
41mm	1.6142	4 7/8	11 5/8	710.00	—
1 5/8	1.6250	4 7/8	11 5/8	695.00	740.00
1 11/16	1.6875	5	11 5/8	729.00	790.00
43mm	1.6929	5	11 5/8	780.00	—
44mm	1.7323	5	11 5/8	780.00	—
1 3/4	1.7500	5	12 3/8	750.00	825.00
46mm	1.8110	5	12 3/8	810.00	—
1 13/16	1.8125	5	12 3/8	785.00	855.00
47mm	1.8504	5	12 3/8	820.00	—
1 7/8	1.8750	5	12 3/4	800.00	890.00
49mm	1.9291	5	12 3/4	950.00	—
1 15/16	1.9375	5	12 3/4	929.00	998.00
2	2.0000	5	13 1/16	950.00	1100.00
2 1/16	2.0625	5 1/8	13 1/4	1100.00	—
2 1/8	2.1250	5 1/8	13 1/4	1200.00	1300.00
2 3/16	2.1875	5 1/8	13 1/2	1250.00	—
2 1/4	2.2500	5 1/4	14	1300.00	1420.00
2 5/16	2.3125	5 3/8	14 1/2	1350.00	—
2 3/8	2.3750	5 3/8	14 1/2	1400.00	1500.00
2 7/16	2.4375	5 3/8	14 1/2	1450.00	1600.00
2 1/2	2.5000	5 3/8	14 1/2	1500.00	—
2 9/16	2.5625	5 1/2	15	1550.00	—
2 5/8	2.6250	5 1/2	15	1600.00	—
2 11/16	2.6875	5 3/4	15 1/2	1650.00	—
2 3/4	2.7500	5 3/4	15 1/2	1700.00	—
2 13/16	2.8125	5 3/4	15 1/2	1750.00	—
2 7/8	2.8750	5 3/4	15 1/2	1800.00	—
2 15/16	2.9375	6	16 1/2	1875.00	—
3	3.0000	6	16 1/2	1975.00	—

Sets - Expansion Hand Reamers

Sizes	Description	No. of Pieces	Set No.	Price
1/4, 3/8, 1/2, 5/8, 3/4	Straight Flute	5	576US	967.67
1/4, 3/8, 1/2, 5/8, 3/4	LH. Spiral/ RH. Cut	5	577US	1091.67

Supplied in Wood Block



Expansion Chucking Reamers High Speed Steel

List No. 572U: Straight Shank, Straight Flute

List No. 574U: Taper Shank, Straight Flute



This is an economical high-production reamer. The expansion feature permits this reamer to be resharpened many times to its original diameter, for cost and replacement purposes.

Available in 64th sizes.
Please inquire.

Maximum Expansion to 1/2 ≈ .006", to 1 ≈ .010", to 1 1/2 ≈ .012", 1-1/2 and over ≈ .015"

Specifications				572U Straight Shank	574U Taper Shank	
Diameter	Decimal Equivalent	Flute Length	Overall Length	Price Each	Morse Taper No.	Price Each
3/16	.1875	3/4	6 1/2	120.50	—	—
7/32	.2188	3/4	6 1/2	120.50	—	—
1/4	.2500	3/4	6 1/2	115.75	—	—
9/32	.2812	3/4	6 1/2	115.75	—	—
5/16	.3125	3/4	6 1/2	115.75	—	—
11/32	.3438	3/4	6 1/2	115.75	—	—
3/8	.3750	3/4	7	79.70	1	89.60
13/32	.4062	3/4	7	82.60	1	95.16
7/16	.4375	7/8	7	84.40	1	97.70
15/32	.4688	7/8	7	87.44	1	99.90
1/2	.5000	1	8	89.10	1	101.14
17/32	.5312	1	8	92.16	1	103.30
9/16	.5625	1 1/8	8	94.11	1	105.90
19/32	.5938	1 1/8	8	96.40	1	107.44
5/8	.6250	1 1/4	9	98.49	2	109.61
21/32	.6562	1 1/4	9	101.50	2	114.59
11/16	.6875	1 1/4	9	103.30	2	116.10
23/32	.7188	1 1/4	9	108.18	2	118.00
3/4	.7500	1 3/8	9 1/2	112.75	2	120.35
25/32	.7812	1 3/8	9 1/2	120.20	2	125.99
13/16	.8125	1 3/8	9 1/2	123.66	2	130.65
27/32	.8438	1 3/8	9 1/2	129.80	2	135.05
7/8	.8750	1 1/2	10	139.66	2	143.60
29/32	.9062	1 1/2	10	142.19	2	149.00
15/16	.9375	1 1/2	10	147.90	3	153.62
31/32	.9688	1 1/2	10	153.16	3	159.99
1	1.0000	1 5/8	10 1/2	159.75	3	166.66
1 1/32	1.0312	1 5/8	10 1/2	175.09	3	179.59
1 1/16	1.0625	1 5/8	10 1/2	180.80	3	185.19
1 3/32	1.0938	1 5/8	10 1/2	190.19	3	195.95
1 1/8	1.1250	1 3/4	11	201.55	3	209.90
1 5/32	1.1562	1 3/4	11	204.19	3	215.08
1 3/16	1.1875	1 3/4	11	210.10	3	225.00
1 13/64	1.2031	1 3/4	11	—	3	280.00
1 7/32	1.2188	1 3/4	11	220.59	3	260.00
1 1/4	1.2500	1 7/8	11 1/2	225.25	4	240.50
1 9/32	1.2812	1 7/8	11 1/2	265.50	—	—
1 5/16	1.3125	1 7/8	11 1/2	230.85	4	245.00
1 11/32	1.3438	1 7/8	11 1/2	275.70	—	—
1 3/8	1.3750	2	12	240.78	4	260.00
1 7/16	1.4375	2	12	250.38	4	272.00
1 1/2	1.5000	2 1/8	12 1/2	260.95	4	280.00
1 9/16	1.5625	2 1/8	12 1/2	325.00	4	355.00
1 5/8	1.6250	2 1/4	13	330.00	4	360.00
1 11/16	1.6875	2 1/4	13	350.00	4	380.00
1 3/4	1.7500	2 3/8	13 1/2	398.00	5	438.00
1 13/16	1.8125	2 3/8	13 1/2	425.00	5	470.00
1 7/8	1.8750	2 1/2	14	480.00	5	525.00
1 15/16	1.9375	2 1/2	14	495.00	5	540.00
2	2.0000	2 1/2	14	505.00	5	555.00
2 1/8	2.1250	2 3/4	14 1/2	600.00	5	665.00
2 3/16	2.1875	2 3/4	14 1/2	—	5	680.00
2 5/16	2.3125	2 3/4	14 1/2	—	5	695.00
2 3/8	2.3750	3	14 1/2	650.00	5	750.00
2 7/16	2.4375	3	15	—	5	775.00
2 1/2	2.5000	3	15	725.00	5	795.00
2 5/8	2.6250	3	16	—	5	995.00
2 11/16	2.6875	3	16	—	5	1095.00
2 13/16	2.8125	3	16	—	5	1295.00
2 7/8	2.8750	3	16	—	5	1395.00
2 15/16	2.9375	3	16	1450.00	5	1450.00
3	3.0000	3	16	—	5	1495.00

Morse Taper Roughing and Finishing Reamers High Speed Steel - Straight Flute

- List No. **568U**: Straight Shank - Finishing Reamers
 List No. **569U**: Taper Shank - Finishing Reamers
 List No. **552U**: Straight Shank - Roughing Reamers
 List No. **559U**: Taper Shank - Roughing Reamers



This tool is used for accurate reaming of Morse Taper holes in sockets, sleeves and spindles.

Specifications						Price Each			
Taper No.	Diameter		Flute Length	Shank Diameter	Morse Taper No.	568U Straight Shank	569U Taper Shank	552U Straight Shank Roughing	559U Taper Shank Roughing
	Small End	Large End							
0	.2503	.3674	2 1/4	5/16	0	58.00	88.00	65.00	99.00
1	.3674	.5170	3	7/16	1	74.00	98.00	82.00	115.00
2	.5696	.7444	3 1/2	5/8	2	89.00	115.00	99.00	130.00
3	.7748	.9881	4 1/4	7/8	3	129.00	160.00	145.00	180.00
4	1.0167	1.2893	5 1/4	1 1/8	4	189.00	250.00	208.00	270.00
5	1.4717	1.8005	6 1/4	1 1/2	5	340.00	520.00	370.00	549.00
6	2.1120	2.5550	8 1/2	2	6	915.00	950.00	960.00	1005.00

Sets - Morse Taper Reamers

Description	Sizes	Pieces	Set No.	Price
Straight Shank, Finishing Reamer	#1 - #5	5	568US	821.00

Brown & Sharpe Taper Reamers - High Speed Steel

- List No. **596U**: Straight Shank, Straight Flute - Finishing Reamers

These reamers are used for final finishing of Brown & Sharpe standard taper holes, and also used for removing nicks or burrs in machine spindles.



Size	Diameter		Flute Length	Shank Diameter	Overall Length	Price Each
	Small End	Large End				
1	.1974	.3176	2 7/8	9/32	4 3/4	74.00
2	.2474	.3781	3 1/8	11/32	5 1/8	83.00
3	.3099	.4510	3 3/8	13/32	5 1/2	89.00
4	.3474	.5017	3 11/16	7/16	5 7/8	92.55
5	.4474	.6145	4	9/16	6 3/8	97.70
6	.4974	.6808	4 3/8	5/8	6 7/8	104.78
7	.5974	.8011	4 7/8	3/4	7 1/2	110.30
8	.7474	.9770	5 1/2	13/16	8 1/8	149.74
9	.8974	1.1530	6 1/8	1	8 7/8	195.00
10	1.0420	1.3376	6 7/8	1 1/8	9 3/8	245.00
11	1.2500	1.5680	7 5/8	1 5/16	10 5/8	485.00
12	1.5000	1.8440	8 1/4	1 5/8	11 3/8	599.00

Sets - Brown & Sharpe Taper Reamers

Sizes	No. of Reamers	Set No.	Price
#1 - #5	5	596US	436.25

Jarno Taper Reamers - High Speed Steel

- List No. **599U**: Straight Shank, Straight Flute - Finishing Reamers



Jarno Taper No.	Size		Overall Length	Price Each
	Small End	Large End		
4	.400	.531	4 3/8	85.00
5	.500	.652	5 1/8	93.00
6	.600	.787	5 7/8	105.00
7	.700	.916	6 5/8	120.00
8	.800	1.044	7 3/8	175.00
9	.900	1.169	8 1/8	199.00

Jarno Taper No.	Size		Overall Length	Price Each
	Small End	Large End		
10	1.000	1.297	8 7/8	210.00
11	1.100	1.422	9 1/2	300.00
12	1.200	1.550	10 1/8	450.00
13	1.300	1.675	10 3/4	510.00
14	1.400	1.800	11 3/8	595.00

Aligning Reamers - High Speed & Cobalt

1/2" Straight Shank with 3 Equal Flats to fit 1/2" Chucks

List No. **535R**: Left Hand Spiral, Right Hand Cut, High Speed
List No. **535RC**: Left Hand Spiral, Right Hand Cut, Cobalt



Used to align existing holes prior to rivet or bolt installation, the point is tapered to allow entry into overlapping holes. These reamers are also useful in portable reaming.

Specifications				Price Each	
Size	Flute Length	Overall Length	Shank Diameter	535R High Speed	535RC Cobalt
1/4*	2 1/2	4 3/8	1/4	46.71	60.72
5/16	2 3/4	4 5/8	5/16	46.71	60.72
3/8	2 3/4	4 5/8	3/8	46.71	60.72
7/16	3 1/2	5 3/8	7/16	48.40	62.92
1/2	4	5 7/8	1/2	48.40	62.92
9/16	4	5 7/8	1/2	53.90	70.07
5/8	4 1/2	6 3/8	1/2	56.10	72.93
11/16	4 1/2	6 3/8	1/2	62.43	81.15
3/4	5	6 7/8	1/2	74.75	97.17
13/16	5	6 7/8	1/2	75.35	97.95
7/8	5	6 7/8	1/2	80.85	105.10
15/16	5	6 7/8	1/2	84.59	109.96
1	5	6 7/8	1/2	98.89	128.55
1 1/16	5	6 7/8	1/2	115.50	150.15

Sets - Aligning Reamers

* No Flats on Shank

Sizes	Description	No. of Pcs.	Part No.	Price
1/2, 9/16, 5/8, 3/4	High Speed Steel	4	535RS	237.40
1/2, 9/16, 5/8, 3/4	Cobalt	4	535RCS	303.09

Supplied in Wood Block

Hex Nut Shank Style

List No. **535H**: Left Hand Spiral Flute

For portable pneumatic tools, the short length permits use in limited-access areas. The hex nut diameter for each reamer matches socket size for the bolt which will be driven through the newly reamed hole.



Size	Flute Length	Overall Length	Hex Shank Diameter	Price Each
11/16	4 1/2	6 1/2	1 1/16	78.10
13/16	5	7	1 1/4	95.15
15/16	5	7	1 7/16	105.60
1 1/16	5	7	1 5/8	141.90
1 3/16	5	7	1 13/16	196.00

Construction Reamers - High Speed Steel

1/2" Straight Shank with 3 Equal Flats to fit 1/2" Chucks

List No. **583CR**: Left Hand Spiral Flute with stop collar

Used to align existing holes prior to rivet or bolt installation, the point is tapered to allow entry into overlapping holes. These reamers are also useful in portable reaming.



Size	Decimal Equivalent	Flute Length	Overall Length	Shank Diameter	Price Each
3/8*	.3750	3 5/8	5 1/4	.3750	36.32
7/16*	.4375	3 5/8	5 1/4	.4375	48.00
1/2	.5000	4 3/8	6	.5000	55.13
9/16	.5625	5	6 5/8	.5000	64.72
5/8	.6250	5	6 5/8	.5000	74.90
11/16	.6875	5 3/8	7	.5000	88.48
3/4	.7500	5 3/8	7	.5000	100.76
13/16	.8125	5 5/8	7 1/4	.5000	104.31
7/8	.8750	5 5/8	7 1/4	.5000	104.31
15/16	.9375	5 5/8	7 1/4	.5000	130.88
1	1.0000	5 5/8	7 1/4	.5000	130.88

Sets - Construction Reamers

* Shank diameter same as cutting diameter.

Sizes	Description	No. of Pcs.	Part No.	Price
1/2, 9/16, 5/8, 3/4	High Speed Steel	4	583CRS	299.76

Supplied in Wood Block

Bridge Reamers - Taper Shank Long Body, High Speed Steel

List No. 532: Left Hand Spiral, Right Hand Cut
List No. 533: Straight Flute



Structural reamers are used extensively in shipbuilding, bridge construction, and boiler manufacturing. These reamers are designed to ream rough and undersize holes that are previously punched or drilled in steel plates or shapes. They are used where it is necessary to ream holes in assemblies to obtain proper alignment and size to precisely fit rivets, bolts, etc.

Specifications					Price Each	
Size	Approx. Point Size	Flute Length	Overall Length	Morse Taper No.	532 LH Spiral	533 Straight Flute
9/32	5/32	4	7 1/4	1	55.20	62.40
5/16	7/32	4	7 1/4	2	55.20	62.40
11/32	7/32	4	7 1/4	2	58.80	62.40
3/8	1/4	4 1/2	8 1/4	2	58.80	62.40
13/32	1/4	4 1/2	8 1/4	2	58.80	62.40
7/16	1/4	4 1/2	8 1/4	2	45.96	62.40
15/32	1/4	5 1/8	9	2	60.62	81.60
1/2	9/32	5 1/8	9	2	60.62	76.32
33/64	9/32	5 1/8	9	2	61.58	76.32
17/32	9/32	5 1/8	9	2	64.80	76.32
9/16	11/32	5 1/8	9	2	69.60	76.32
37/64	3/8	5 1/8	9	2	83.52	95.04
5/8	3/8	6 1/8	10	2	91.20	95.04
11/16	25/64	7 1/8	11 3/4	3	100.80	110.00
3/4	7/16	7 3/8	12	3	109.29	116.16
25/32	1/2	7 3/8	12	3	109.29	116.16
13/16	1/2	7 3/8	12	3	120.00	125.00
7/8	9/16	7 3/8	12	3	107.52	116.16
29/32	5/8	7 3/8	12	3	122.88	133.92
15/16	5/8	7 3/8	12	3	136.32	139.00
31/32	5/8	7 3/8	12	3	149.00	----
1	11/16	7 3/8	12	3	135.12	168.00

Specifications					Price Each	
Size	Approx. Point Size	Flute Length	Overall Length	Morse Taper No.	532 LH Spiral	533 Straight Flute
1 1/16	3/4	7 3/8	12	3	148.80	152.00
1 1/8	13/16	7 3/8	12	3	158.40	165.00
1 5/32	7/8	7 3/8	12	3	168.00	170.88
1 3/16	7/8	7 3/8	12	3	155.00	168.50
1 7/32	15/16	7 3/8	13	4	185.28	205.44
1 1/4	15/16	7 3/8	13	4	175.00	180.00
1 9/32	1	7 3/8	13	4	214.08	225.60
1 5/16	1	7 3/8	13	4	210.00	215.00
1 11/32	1 1/8	7 3/8	13	4	242.88	254.40
1 3/8	1 1/8	7 3/8	13	4	249.60	255.00
1 13/32	1 3/16	7 3/8	13	4	254.40	266.88
1 7/16	1 3/16	7 3/8	13	4	285.12	297.60
1 1/2	1 1/4	7 3/8	13	4	320.00	382.08
1 17/32	1 3/8	7 3/8	13	4	374.40	382.08
1 9/16	1 3/8	7 3/8	13	4	390.00	395.00
1 5/8	1 3/8	7 3/8	13	4	408.00	410.00
1 3/4	1 11/16	7 3/8	13 3/4	5	450.00	----
1 7/8	1 11/16	7 3/8	13 3/4	5	475.00	480.00
1 15/16	1 11/16	7 3/8	13	5	495.00	----
1 31/32	1 11/16	7 3/8	13	4	499.00	510.00
2	1 11/16	7 3/8	13 3/4	5	499.00	----

Car Reamers - Taper Shank, Short Body, High Speed Steel

List No. 535: Left Hand Spiral, Right Hand Cut
List No. 534: Straight Flute



Car reamers are specially designed for reaming structural steel plates, commonly found in railroad cars, truck frames, bridge building/repair, and pressure vessel manufacturing. These reamers are used on previously formed holes in steel plates which are under size and rough, and where it is necessary to ream holes in assemblies to obtain proper alignment and size to precisely fit rivets, bolts, etc.

Specifications					Price Each	
Size	Approx. Point Size	Flute Length	Overall Length	Morse Taper No.	535 LH Spiral	534 Straight Flute
1/4	11/64	2 1/2	5 1/2	1	47.75	63.32
9/32	11/64	2 1/2	5 1/2	1	49.50	64.97
5/16	11/64	2 3/4	5 11/16	1	37.13	52.60
11/32	15/64	2 3/4	5 11/16	1	48.00	59.00
3/8	15/64	2 3/4	5 11/16	1	37.80	----
25/64	15/64	2 3/4	5 11/16	1	48.00	----
27/64	1/4	3 1/2	6 15/16	2	48.00	----
7/16	1/4	3 1/2	6 15/16	2	44.31	63.85
29/64	9/32	3 1/2	7 1/16	2	55.00	----
15/32	9/32	3 1/2	7 1/16	2	55.00	65.00
1/2	19/64	4	7 9/16	2	51.00	70.00

Specifications					Price Each	
Size	Approx. Point Size	Flute Length	Overall Length	Morse Taper No.	535 LH Spiral	534 Straight Flute
33/64	19/64	4	7 9/16	2	60.00	----
35/64	19/64	4	7 9/16	2	60.00	----
9/16	19/64	4	7 9/16	2	52.70	----
5/8	5/16	4 1/2	8 1/16	2	61.25	73.75
11/16	3/8	4 1/2	8 13/16	3	65.66	85.37
3/4	13/32	5	9 1/2	3	71.75	100.99
13/16	15/32	5	9 1/2	3	73.90	102.95
15/16	19/32	5	9 1/2	3	81.99	112.00
1 3/16	25/32	5	9 1/2	3	----	147.00
1 1/4	25/32	5	9 1/2	3	----	158.00

Taper Shank Chucking Reamers

High Speed Steel

List No. **530U**: Straight Flute

List No. **531U**: Right Hand Spiral, Right Hand Cut

List No. **537LU**: Left Hand Spiral, Right Hand Cut

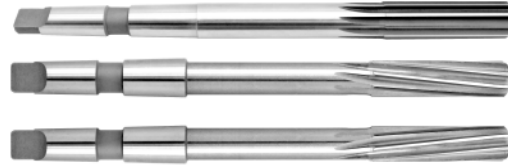

These reamers are designed and applied similarly to straight shank reamers (L&I No. LV533 & LV535) except they are manufactured with Morse taper shanks.

Specifications						Price Each		
Diameter	Decimal Equivalent	Flute Length	Overall Length	Morse Taper No.	No. of Flutes	530U Straight Flute	531U RH Spiral RH Cut	537LU LH Spiral RH Cut
1/8	.1250	7/8	4 3/8	1	6	27.50	----	----
3/16	.1875	1 1/8	4 1/2	1	6	27.50	----	----
5mm	.1969	1 1/4	5	1	6	32.00	----	----
13/64	.2031	1 1/4	5	1	6	29.00	35.00	----
7/32	.2188	1 1/4	5	1	6	----	36.50	----
15/64	.2344	1 1/4	5	1	6	----	34.50	----
6mm	.2362	1 1/4	5	1	6	32.00	----	36.00
1/4	.2500	1 1/2	6	1	6	27.75	32.00	36.00
6.5mm	.2559	1 1/2	6	1	6	32.00	----	----
17/64	.2656	1 1/2	6	1	6	38.00	42.50	----
7mm	.2756	1 1/2	6	1	6	38.00	----	----
9/32	.2812	1 1/2	6	1	6	29.00	33.00	36.00
19/64	.2969	1 1/2	6	1	6	38.00	43.00	----
5/16	.3125	1 1/2	6	1	6	29.00	33.00	36.00
8mm	.3150	1 1/2	6	1	6	38.00	----	----
21/64	.3281	1 1/2	6	1	6	----	43.00	----
11/32	.3438	1 1/2	6	1	6	32.00	35.00	39.00
9mm	.3543	1 3/4	7	1	6	38.00	----	40.00
23/64	.3594	1 3/4	7	1	6	40.00	----	----
3/8	.3750	1 3/4	7	1	6	33.50	36.00	40.00
25/64	.3906	1 3/4	7	1	6	----	46.00	49.00
10mm	.3937	1 3/4	7	1	6	38.00	----	----
13/32	.4062	1 3/4	7	1	6	34.80	38.00	49.00
11mm	.4331	1 3/4	7	1	6	38.00	----	----
7/16	.4375	1 3/4	7	1	6	34.80	38.50	42.00
29/64	.4531	1 3/4	7	1	6	42.00	----	----
15/32	.4688	1 3/4	7	1	6	35.75	41.40	44.50
12mm	.4724	2	8	1	6	38.20	----	----
31/64	.4844	2	8	1	6	----	49.50	----
1/2	.5000	2	8	1	6	38.20	42.16	45.70
13mm	.5118	2	8	1	6	46.00	----	48.00
17/32	.5312	2	8	1	6	42.25	44.80	48.00
14mm	.5512	2	8	1	6	48.00	----	----
9/16	.5625	2	8	1	6	44.40	47.00	54.00
37/64	.5781	2	8	1	6	48.00	55.00	----
15mm	.5906	2	8	1	6	52.00	----	----
19/32	.5938	2	8	1	6	46.36	49.40	57.00
39/64	.6094	2	8	1	6	----	58.50	----
5/8	.6250	2 1/4	9	2	8	49.90	51.25	57.00
21/32	.6562	2 1/4	9	2	8	51.20	53.00	----
11/16	.6875	2 1/4	9	2	8	51.20	54.10	59.00
23/32	.7188	2 1/4	9	2	8	54.60	59.60	----
47/64	.7344	2 1/4	9	2	8	----	67.90	----
3/4	.7500	2 1/2	9 1/2	2	8	54.60	59.60	63.60
25/32	.7812	2 1/2	9 1/2	2	8	64.00	68.20	72.00
20mm	.7874	2 1/2	9 1/2	2	8	70.00	----	----
13/16	.8125	2 1/2	9 1/2	2	8	64.00	68.20	73.20
21mm	.8268	2 1/2	9 1/2	2	8	72.00	----	----
27/32	.8438	2 1/2	9 1/2	2	8	69.10	75.00	79.00
22mm	.8661	2 1/2	9 1/2	2	8	77.00	----	----
7/8	.8750	2 5/8	10	2	8	72.20	75.00	79.00
23mm	.9055	2 5/8	10	2	8	85.50	----	----
29/32	.9062	2 5/8	10	2	8	78.60	84.70	89.00
59/64	.9219	2 5/8	10	3	8	----	----	89.00
15/16	.9375	2 5/8	10	3	8	78.60	84.70	89.00
24mm	.9449	2 5/8	10	3	8	89.00	----	----
31/32	.9688	2 5/8	10	3	8	85.40	90.80	95.00
25mm	.9843	2 5/8	10	3	8	93.00	----	----
1	1.0000	2 3/4	10 1/2	3	8	87.70	90.80	----
26mm	1.0236	2 3/4	10 1/2	3	10	93.00	----	----
1 1/32	1.0312	2 3/4	10 1/2	3	10	118.00	125.00	----

Taper Shank Chucking Reamers High Speed Steel

List No. **530U**: Straight Flute

List No. **531U**: Right Hand Spiral, Right Hand Cut

List No. **537LU**: Left Hand Spiral, Right Hand Cut



These reamers are designed and applied similarly to straight shank reamers (L&I No. LV533 & LV535) except they are manufactured with Morse taper shanks.

Specifications						Price Each		
Diameter	Decimal Equivalent	Flute Length	Overall Length	Morse Taper No.	No. of Flutes	530U Straight Flute	531U RH Spiral RH Cut	537LU LH Spiral RH Cut
1 1/16	1.0625	2 3/4	10 1/2	3	10	92.00	101.10	----
1 3/32	1.0938	2 7/8	11	3	10	124.00	130.00	----
1 1/8	1.1250	2 7/8	11	3	10	99.00	110.70	116.00
1 5/32	1.1562	2 7/8	11	3	10	144.00	152.80	----
1 3/16	1.1875	2 7/8	11	3	10	114.50	125.80	145.00
1 7/32	1.2188	3	11 1/2	4	10	150.00	160.00	----
1 1/4	1.2500	3	11 1/2	4	10	130.00	139.75	150.00
1 9/32	1.2812	3	11 1/2	4	10	125.00	160.00	----
33mm	1.2992	3	11 1/2	4	10	165.00	----	----
1 5/16	1.3125	3	11 1/2	4	10	140.00	149.70	155.00
1 11/32	1.3438	3 1/4	12	4	10	165.00	166.00	----
1 3/8	1.3750	3 1/4	12	4	12	148.00	159.10	165.00
1 13/32	1.4062	3 1/4	12	4	12	175.00	190.00	----
1 7/16	1.4375	3 1/4	12	4	12	159.00	179.60	188.00
1 15/32	1.4688	3 1/2	12 1/2	4	12	190.00	210.00	----
1 1/2	1.5000	3 1/2	12 1/2	4	12	170.00	190.75	194.00
1 9/16	1.5625	3 1/2	12 1/2	4	12	237.00	260.00	----
1 5/8	1.6250	4	13 1/2	4	12	245.00	272.00	275.00
1 11/16	1.6875	4	13 1/2	4	12	285.00	300.00	----
1 3/4	1.7500	4	13 1/2	4	12	325.05	341.00	----
1 13/16	1.8125	4	13 1/2	4	12	350.00	390.00	----
1 7/8	1.8750	4	14	4	12	375.00	405.75	----
1 15/16	1.9375	4	14	4	12	395.00	420.00	----
2	2.0000	4	14 1/2	4	12	404.25	425.00	----
2 3/16	2.1875	4 1/2	14 7/8	5	14	695.00	----	----
2 1/4	2.2500	4 1/2	14 7/8	5	14	750.00	----	----
2 5/16	2.3125	4 3/4	15 1/4	5	14	775.00	----	----
2 3/8	2.3750	5	16	5	16	795.00	----	----

Diameter Tolerance:	up to 1/2" -0.0000" -0.000m/m +0.0002" +0.005m/m	1/2" to 5/8" -0.0000" -0.000m/m +0.0003" +0.008m/m	5/8" to 1" +0.0001" +0.0025m/m +0.0005" +0.012m/m	1" to 3" +0.0002" +0.005m/m +0.0006" +0.015m/m
----------------------------	---	---	--	---

Taper Shank Jobber Reamers High Speed Steel

List No. **578U**: Straight Flute. These reamers are designed for machine use in applications where long flutes are required.



Diameter	Dec. Equiv.	Flute Length	Overall Length	Morse Taper No.	No. of Flutes	Price Each
3/16	.1875	1 7/8	5 1/16	1	6	54.00
1/4	.2500	2	5 3/16	1	6	51.98
9/32	.2812	2	5 3/16	1	6	51.98
5/16	.3125	2 1/4	5 1/2	1	6	52.32
11/32	.3438	2 1/4	5 1/2	1	6	59.49
3/8	.3750	2 1/2	5 13/16	1	6	63.70
13/32	.4062	2 1/2	5 13/16	1	6	67.50
7/16	.4375	2 3/4	6 1/8	1	6	69.20
15/32	.4688	2 3/4	6 1/8	1	6	72.50
1/2	.5000	3	6 7/16	1	6	74.60
17/32	.5312	3	6 7/16	1	6	78.21
14mm	.5512	3 1/4	6 3/4	1	6	89.00
9/16	.5625	3 1/4	6 3/4	1	6	84.11
19/32	.5938	3 1/4	6 3/4	1	6	86.04
5/8	.6250	3 1/2	7 9/16	2	8	89.30
21/32	.6562	3 1/2	7 9/16	2	8	91.60
11/16	.6875	3 7/8	8	2	8	95.17
23/32	.7188	3 7/8	8	2	8	99.20

Diameter	Dec. Equiv.	Flute Length	Overall Length	Morse Taper No.	No. of Flutes	Price Each
3/4	.7500	4 3/16	8 3/8	2	8	104.40
25/32	.7812	4 3/8	8 3/4	2	8	120.00
13/16	.8125	4 9/16	8 13/16	2	8	114.16
27/32	.8438	4 7/8	9 3/16	2	8	140.00
7/8	.8750	4 7/8	9 3/16	2	8	125.70
29/32	.9062	4 7/8	9 3/16	2	8	148.70
15/16	.9375	5 1/8	10	3	8	139.90
31/32	.9688	5 7/16	10 3/8	3	8	174.00
1	1.0000	5 7/16	10 3/8	3	8	151.10
1 1/16	1.0625	5 5/8	10 5/8	3	10	174.00
1 1/8	1.1250	5 13/16	10 7/8	3	10	185.00
1 3/16	1.1875	6	11 1/8	3	10	195.80
1 1/4	1.2500	6 1/8	12 9/16	4	10	215.75
1 5/16	1.3125	6 1/4	12 11/16	4	10	299.00
1 3/8	1.3750	6 5/16	12 13/16	4	12	350.00
1 7/16	1.4375	6 7/16	13	4	12	410.00
1 1/2	1.5000	6 1/2	13 1/8	4	12	480.00
2	2.0000	7	14	4	12	575.00

Taper Pin Reamers - High Speed Steel - Straight Shank

List No. **556U**: Straight Flute

List No. **557U**: Left Hand Spiral, Right Hand Cut

List No. **558U**: Left Hand Helical Flute, Right Hand Cut

These are for machine reaming of holes for taper pins. Series 558U has a high helix flute design that eases chip ejection.



Specifications						Price Each		
Size	Diameter		Flute Length	Overall Length	Shank Diameter	556U Straight Flute	557U LH Spiral RH Cut	558U Helical Flute
	Small End	Large End						
7/0	.0497	.0666	13/16	1 13/16	5/64	38.50	39.75	40.55
6/0	.0611	.0806	15/16	1 15/16	3/32	38.50	39.75	40.55
5/0	.0719	.0966	1 3/16	2 3/16	7/64	36.25	38.99	40.55
4/0	.0869	.1142	1 5/16	2 5/16	1/8	36.25	38.99	40.55
3/0	.1029	.1302	1 5/16	2 5/16	9/64	36.25	38.99	40.55
2/0	.1137	.1462	1 9/16	2 9/16	5/32	36.25	38.99	40.55
0	.1287	.1638	1 11/16	2 15/16	11/64	31.00	33.00	34.29
1	.1447	.1798	1 11/16	2 15/16	3/16	29.50	33.00	34.29
2	.1605	.2008	1 15/16	3 3/16	13/64	29.50	33.00	36.43
3	.1813	.2294	2 5/16	3 11/16	15/64	29.50	33.00	39.80
4	.2071	.2604	2 9/16	4 1/16	17/64	32.75	35.65	44.23
5	.2409	.2994	2 13/16	4 5/16	5/16	36.07	38.35	48.00
6	.2773	.3540	3 11/16	5 7/16	23/64	42.50	47.18	58.35
7	.3297	.4220	4 7/16	6 5/16	13/32	55.80	59.95	71.32
8	.3971	.5050	5 3/16	7 3/16	7/16	72.00	79.00	82.99
9	.4805	.6066	6 1/16	8 5/16	9/16	83.00	91.95	89.50
10	.5799	.7216	6 13/16	9 5/16	5/8	91.50	102.50	112.25
11	.7060	.8780	8 1/4	11 1/4	11/16	105.80	113.20	130.75
12	.8420	1.0500	10	13 5/8	3/4	163.30	170.00	198.23
13	1.0090	1.2590	12	16	1 1/16	317.40	339.61	535.52
14	1.2500	1.5420	14	18 1/4	1 3/8	512.90	548.80	620.21

Note: 1/4 taper per foot

Sets - Taper Pin Reamers

Sizes	Description	No. of Pcs.	Part No.	Price
7/0, 6/0, 5/0, 4/0, 3/0, 2/0, 0, 1, 2, 3, 4, 5, 6, 7, 8, 9, 10	Straight Flute	17	556USA	780.12
0, 1, 2, 3, 4, 5, 6, 7, 8, 9, 10	Straight Flute	11	556USB	559.11
7/0, 6/0, 5/0, 4/0, 3/0, 2/0, 0, 1, 2, 3, 4, 5, 6, 7, 8, 9, 10	Left Hand Spiral	17	557USA	845.55
0, 1, 2, 3, 4, 5, 6, 7, 8, 9, 10	Left Hand Spiral	11	557USB	611.58
7/0, 6/0, 5/0, 4/0, 3/0, 2/0, 0, 1, 2, 3, 4, 5, 6, 7, 8, 9, 10	Left Hand Helical Flute	17	558USA	915.14
0, 1, 2, 3, 4, 5, 6, 7, 8, 9, 10	Left Hand Helical Flute	11	558USB	675.16

Metric Taper Pin Reamers - High Speed Steel - Straight Shank

List No. **556MU**: Straight Flute

List No. **557MU**: Left Hand Spiral, Right Hand Cut

These are for machine reaming of holes for taper pins.



Specifications					Price Each	
Size	Diameter		Flute Length	Overall Length	556MU Straight Flute	557MU LH Spiral RH Cut
	Small End	Large End				
2.00	.0748	.1127	1 7/8	2 5/8	41.00	43.00
2.50	.0945	.1324	1 7/8	2 7/8	41.00	43.00
3.00	.1142	.1600	2 1/4	3 1/4	41.00	43.00
4.00	.1535	.2072	2 11/16	3 5/8	35.00	37.10
5.00	.1929	.2506	2 7/8	4	36.00	—
6.00	.2323	.3150	4 3/16	5 3/8	45.00	47.70
8.00	.3110	.4252	5 3/4	7	77.00	—
10.00	.3898	.5276	6 7/8	8 1/2	93.00	98.58
12.00	.4646	.6299	8 1/4	10	132.00	139.92
14.00	.5437	.7092	8 1/4	10	155.00	—
16.00	.6220	.8031	9	11	185.00	—
20.00	.7795	.9771	9 7/8	12 1/4	198.00	—

Note: Taper 1mm per 50mm

Taper Pipe Reamers High Speed Steel

List No. **566U**: Straight Flute

List No. **567U**: Left Hand Spiral, Right Hand Cut



Taper Pipe Reamers are for reaming holes to be tapped with taper pipe taps. They are tapered 3/4" to the foot.

Specifications						Price Each	
Size	Diameter		Flute Length	Shank Diameter	Overall Length	566U	567U
	Small End	Large End				Straight Flt.	LH Spiral
1/16	.2450	.2910	3/4	.3125	2	48.00	52.00
1/8	.3160	.3620	3/4	.4375	2 1/8	48.00	52.00
1/4	.4060	.4720	1 1/16	.5625	2 7/16	53.90	58.00
3/8	.5400	.6060	1 1/16	.7000	2 9/16	58.00	64.00
1/2	.6650	.7510	1 3/8	.6875	3 1/8	73.00	79.00
3/4	.8760	.9620	1 3/8	.9063	3 1/4	105.00	112.00
1	1.1030	1.2120	1 3/4	1.1250	3 3/4	159.00	168.00
1 1/4	1.4440	1.5530	1 3/4	1.3125	4	249.00	262.00
1 1/2	1.6840	1.7930	1 3/4	1.5000	4 1/4	319.00	345.00
2	2.1590	2.2680	1 3/4	1.8750	4 1/2	420.00	455.00
2 1/2	2.5610	2.7220	2 5/8	2.2050	5 1/2	675.00	720.00
3	3.3020	3.3800	2 3/4	2.6250	6	885.00	935.00

Taper Pipe Taps - High Speed Steel Ground Thread

Taper pipe taps are utilized to thread pipe fittings hence their nominal size is of the pipe being threaded.

List No. **790U**: Taper (NPT)



Size	Threads Per Inch	Price Each	Size	Threads Per Inch	Price Each	Size	Threads Per Inch	Price Each
1/16	27	25.68	1/2	14	59.33	2	11 1/2	328.50
1/8SM*	27	25.68	3/4	14	83.11	2-1/2	8	690.62
1/8LG*	27	25.68	1	11 1/2	125.88	3	8	973.35
1/4	18	28.40	1-1/4	11 1/2	180.77	3-1/2	8	1071.00
3/8	18	37.45	1-1/2	11 1/2	241.95	4	8	1327.50

* SM indicates small diameter shank, and LG indicates large diameter shank.

Taper Pipe Taps - Interrupted Thread High Speed Steel - Ground Thread

For tapping tough, or gummy metals that have a tendency to load the tap teeth.

List No. **792U**: Taper (INT/NPT)



Size	Threads Per Inch	Price Each	Size	Threads Per Inch	Price Each	Size	Threads Per Inch	Price Each
1/16	27	39.86	1/2	14	88.99	1-1/2	11 1/2	367.36
1/8	27	39.86	3/4	14	125.83	2	11 1/2	494.36
1/4	18	44.22	1	11-1/2	194.48			
3/8	18	55.80	1-1/4	11-1/2	273.47			

Carbon Taper Pipe Taps - Cut Thread

List No. **793U**: Taper (NPT)



Size	Threads Per Inch	Price Each	Size	Threads Per Inch	Price Each	Size	Threads Per Inch	Price Each
1/16	27	10.17	1/2	14	20.62	1-1/2	11-1/2	81.07
1/8	27	10.17	3/4	14	33.03	2	11-1/2	124.16
1/4	18	12.00	1	11-1/2	48.68			
3/8	18	15.53	1-1/4	11-1/2	57.43			

Shell Reamers - High Speed Steel

List No. **560U**: Straight Flute

List No. **561U**: Left Hand Spiral, Right Hand Cut



Shell reamers are machine reamers manufactured in high speed steel. Fluted almost their entire length, they have a tapered hole (1/8" taper per foot) which fits on a tapered arbor. The slots in the reamer engage lugs on the arbor, providing ample strength of drive. *Special sizes are available upon request.*

Specifications							Price Each	
Diameter	Decimal Equivalent	Flute Length	Overall Length	ID Hole Lg. End	Fitting Arbor No.	No. of Flutes	560U Straight Flute	561U LH. Spiral RH. Cut
21/32	.6562	1 1/2	2 1/4	3/8	4	10	75.00	—
3/4	.7500	1 1/2	2 1/4	3/8	4	10	70.65	86.31
13/16	.8125	1 3/4	2 1/2	1/2	5	10	73.14	87.45
27/32	.8438	1 3/4	2 1/2	1/2	5	10	—	98.00
7/8	.8750	1 3/4	2 1/2	1/2	5	10	78.47	89.66
15/16	.9375	1 3/4	2 1/2	1/2	5	10	82.15	91.85
1	1.0000	1 3/4	2 1/2	1/2	5	10	87.07	98.51
1 1/64	1.0156	2	2 3/4	5/8	6	10	—	118.00
1 3/64	1.0469	2	2 3/4	5/8	6	10	—	118.00
1 1/16	1.0625	2	2 3/4	5/8	6	10	94.40	107.00
1 5/64	1.0781	2	2 3/4	5/8	6	10	—	125.00
1 3/32	1.0938	2	2 3/4	5/8	6	10	—	125.00
1 1/8	1.1250	2	2 3/4	5/8	6	10	100.22	110.31
1 5/32	1.1562	2	2 3/4	5/8	6	12	—	130.00
1 3/16	1.1875	2	2 3/4	5/8	6	12	103.55	114.13
1 1/4	1.2500	2	2 3/4	5/8	6	12	105.07	119.10
1 5/16	1.3125	2 1/4	3	3/4	7	12	111.54	124.12
1 11/32	1.3438	2 1/4	3	3/4	7	12	128.00	140.00
1 3/8	1.3750	2 1/4	3	3/4	7	12	118.69	130.59
1 7/16	1.4375	2 1/4	3	3/4	7	12	130.48	144.07
1 1/2	1.5000	2 1/4	3	3/4	7	12	138.29	152.10
1 9/16	1.5625	2 1/4	3	3/4	7	12	155.58	170.49
1 5/8	1.6250	2 1/4	3	3/4	7	12	165.62	185.96
1 11/16	1.6875	2 1/2	3 1/2	1	8	12	182.11	203.58
1 3/4	1.7500	2 1/2	3 1/2	1	8	12	192.79	216.04
1 13/16	1.8125	2 1/2	3 1/2	1	8	12	205.77	231.50
1 53/64	1.8281	2 1/2	3 1/2	1	8	12	270.00	—
1 27/32	1.8438	2 1/2	3 1/2	1	8	12	240.00	253.00
1 7/8	1.8750	2 1/2	3 1/2	1	8	12	219.40	245.49
1 29/32	1.9062	2 1/2	3 1/2	1	8	12	260.00	275.00
1 15/16	1.9375	2 1/2	3 1/2	1	8	14	251.00	261.67
2	2.0000	2 1/2	3 1/2	1	8	14	241.70	268.92
2 1/16	2.0625	2 3/4	3 3/4	1 1/4	9	14	261.29	293.89
2 1/8	2.1250	2 3/4	3 3/4	1 1/4	9	14	274.29	307.96
2 3/16	2.1875	2 3/4	3 3/4	1 1/4	9	14	291.50	327.88
2 1/4	2.2500	2 3/4	3 3/4	1 1/4	9	14	301.60	338.14
2 5/16	2.3125	2 3/4	3 3/4	1 1/4	9	14	318.65	358.06
2 3/8	2.3750	2 3/4	3 3/4	1 1/4	9	14	331.88	372.70
2 7/16	2.4375	2 3/4	3 3/4	1 1/4	9	14	342.47	387.60
2 1/2	2.5000	2 3/4	3 3/4	1 1/4	9	14	354.76	398.26
2 9/16	2.5625	4	5	1 1/2	10	16	501.12	555.64
2 5/8	2.6250	4	5	1 1/2	10	16	533.60	576.28
2 11/16	2.6875	4	5	1 1/2	10	16	566.89	596.64
2 3/4	2.7500	4	5	1 1/2	10	16	595.08	646.70
2 13/16	2.8125	4	5	1 1/2	10	16	629.53	694.84
2 7/8	2.8750	4	5	1 1/2	10	16	665.55	718.73
2 15/16	2.9375	4	5	1 1/2	10	16	702.38	754.00
3	3.0000	4	5	1 1/2	10	16	737.58	795.52
3 1/16	3.0625	4 1/2	5 1/2	1 3/4	11	16	934.90	—
3 1/8	3.1250	4 1/2	5 1/2	1 3/4	11	16	1130.65	—
3 3/16	3.1875	4 1/2	5 1/2	1 3/4	11	16	1168.12	—
3 1/4	3.2500	4 1/2	5 1/2	1 3/4	11	16	1205.82	—
3 5/16	3.3125	4 1/2	5 1/2	1 3/4	11	16	1247.00	1307.32
3 3/8	3.3750	4 1/2	5 1/2	1 3/4	11	16	1288.76	1354.59
3 7/16	3.4375	4 1/2	5 1/2	1 3/4	11	16	—	1392.00
3 1/2	3.5000	4 1/2	5 1/2	1 3/4	11	16	1361.84	1429.70
3 9/16	3.5625	5	6	2	12	18	—	1467.34
3 5/8	3.6250	5	6	2	12	18	—	1503.36
3 7/8	3.8750	5	6	2	12	20	1619.36	—
3 15/16	3.9375	5	6	2	12	20	1668.08	—
4	4.0000	5	6	2	12	20	—	1806.12

Carbide Tipped Shell Reamers: Straight Flute

List No. **CT560**: Straight Flute



Shell reamers are machine reamers manufactured in high speed steel. Fluted almost their entire length, they have a tapered hole (1/8" taper per foot) which fits on a tapered arbor. The slots in the reamer engage lugs on the arbor, providing ample strength of drive.

Diameter	No. of Flutes	Flute Length	Overall Length	Hole Diameter	Price Each
3/4	6	1 7/16	2 1/4	3/8	188.86
13/16	6	1 11/16	2 1/2	1/2	192.00
7/8	6	1 11/16	2 1/2	1/2	204.40
15/16	8	1 11/16	2 1/2	1/2	206.40
1	8	1 11/16	2 1/2	1/2	211.20
1 1/16	8	1 13/16	2 3/4	5/8	217.80
1 1/8	8	1 13/16	2 3/4	5/8	220.80
1 3/16	8	1 13/16	2 3/4	5/8	225.00
1 1/4	8	1 13/16	2 3/4	5/8	240.00
1 5/16	8	2	3	3/4	243.20
1 3/8	8	2	3	3/4	251.20
1 7/16	8	2	3	3/4	260.00
1 1/2	8	2	3	3/4	270.90
1 9/16	8	2	3	3/4	299.20
1 5/8	8	2	3	3/4	313.60
1 11/16	10	2 11/32	3 1/2	1	340.80
1 3/4	10	2 11/32	3 1/2	1	340.50
1 13/16	10	2 11/32	3 1/2	1	316.40
1 7/8	10	2 11/32	3 1/2	1	366.40

Diameter	No. of Flutes	Flute Length	Overall Length	Hole Diameter	Price Each
1 15/16	10	2 11/32	3 1/2	1	392.00
2	10	2 11/32	3 1/2	1	392.00
2 1/16	12	2 7/16	3 3/4	1 1/4	420.80
2 1/8	12	2 7/16	3 3/4	1 1/4	420.80
2 3/16	12	2 7/16	3 3/4	1 1/4	459.20
2 1/4	12	2 7/16	3 3/4	1 1/4	459.20
2 5/16	12	2 7/16	3 3/4	1 1/4	484.80
2 3/8	12	2 7/16	3 3/4	1 1/4	484.80
2 7/16	12	2 7/16	3 3/4	1 1/4	494.40
2 1/2	12	2 7/16	3 3/4	1 1/4	494.40
2 9/16	14	2 11/16	4	1 1/2	560.00
2 5/8	14	2 11/16	4	1 1/2	580.80
2 11/16	14	2 11/16	4	1 1/2	605.20
2 3/4	14	2 11/16	4	1 1/2	624.00
2 13/16	14	2 11/16	4	1 1/2	646.00
2 7/8	14	2 11/16	4	1 1/2	672.00
2 15/16	14	2 11/16	4	1 1/2	609.20
3	14	2 11/16	4	1 1/2	724.80

Shell Reamer Arbors

Hardened & Ground

Used to hold shell reamers, the tapered body is machined at 1/8" per foot to accommodate standard shell reamers.



Specifications					Straight Shank			Taper Shank		
Size	Compatible Reamers		Arbor Diameter	Overall Length	Shank Size	Tool No.	Price Each	Morse Taper No.	Tool No.	Price Each
	Smallest	Largest								
4	21/32	25/32	3/8	9	1/2	SR4S	51.48	2	SR4T	61.38
5	13/16	1 1/32	1/2	9 1/2	5/8	SR5S	57.42	2	SR5T	73.26
6	1 1/16	1 9/32	5/8	10	3/4	SR6S	63.36	3	SR6T	79.20
7	1 5/16	1 5/8	3/4	11	7/8	SR7S	69.30	3	SR7T	87.12
8	1 21/32	2	1	12	1 1/8	SR8S	77.22	4	SR8T	97.02
9	2 1/16	2 1/2	1 1/4	13	1 3/8	SR9S	93.06	4	SR9T	108.90
10	2 9/16	3	1 1/2	14	1 5/8	SR10S	119.46	5	SR10T	124.74
11	3 1/16	3 1/2	1 3/4	15	2	SR11S	168.30	5	SR11T	174.90
12	3 9/16	4	2	16	2 1/8	SR12S	235.62	5	SR12T	243.54

E-Z Eject Shell Reamer Arbors

Hardened & Ground

Used to hold shell reamers, the tapered body is machined at 1/8" per foot to accommodate standard shell reamers.



Specifications						Straight Shank			Taper Shank			
Size	Compatible Reamers		Arbor Diameter	Approx. Length Taper	Overall Length	Wrench Size	Shank Size	Tool No.	Price Each	Morse Taper No.	Tool No.	Price Each
	Smallest	Largest										
4	21/32	25/32	3/8	2 1/4	9	19/32	1/2	SRZ4S	69.92	2	SRZ4T	84.56
5	13/16	1 1/32	1/2	2 1/2	9 1/2	25/32	5/8	SRZ5S	77.69	2	SRZ5T	90.93
6	1 1/16	1 9/32	5/8	2 3/4	10	7/8	3/4	SRZ6S	86.79	3	SRZ6T	102.49
7	1 5/16	1 5/8	3/4	3	11	1 1/16	7/8	SRZ7S	94.36	3	SRZ7T	109.42
8	1 21/32	2	1	3 1/2	12	1 7/16	1 1/8	SRZ8S	104.22	4	SRZ8T	123.95
9	2 1/16	2 1/2	1 1/4	3 3/4	13	1 13/16	1 3/8	SRZ9S	123.56	4	SRZ9T	146.70
10	2 9/16	3	1 1/2	4	14	2 3/16	1 5/8	SRZ10S	200.66	5	SRZ10T	216.84
11	3 1/16	3 1/2	1 3/4	4 1/2	15	2 9/16	2	SRZ11S	269.24	5	SRZ11T	281.30
12	3 9/16	4	2	5	16	3 1/8	2 1/8	SRZ12S	331.75	5	SRZ12T	345.45

Carbide Tipped Shell Reamers & Arbors

Drill & Reamer Blanks

M2 – High Speed Steel

Made from hardened (Rc 63-65) M2 grade High Speed Steel and ground, these Drill and Reamer Blanks can be used as punches, gauges, pins or ground for special tools.



List No. **950D**: Drill Blanks (Up to 1/2" + .0000/ - .0003, over 1/2" + .0000/ - .0005)

List No. **950R**: Reamer Blanks (+.0002/-.0000, up to 1/2" - over 1/2" +.0005/-.0000)

Fractional Sizes

Specifications				Price Each	
Size	Dec. Equiv.	Overall Length	Pkg. Qty.	Drill Blank 950D	Reamer Blank 950R
1/64	.0156	3/4	12	1.74	2.37
1/32	.0312	1-3/8	12	1.74	2.37
3/64	.0469	1-3/4	12	1.89	2.58
1/16	.0625	1-7/8	12	1.83	2.50
5/64	.0781	2	12	1.95	2.66
3/32	.0938	2-1/4	12	1.89	2.58
7/64	.1094	2-5/8	12	1.95	2.66
1/8	.1250	2-3/4	12	1.85	2.52
9/64	.1406	2-7/8	12	1.95	2.66
5/32	.1562	3-1/8	12	2.14	2.92
11/64	.1719	3-1/4	12	2.14	2.92
3/16	.1875	3-1/2	12	2.40	3.27
13/64	.2031	3-5/8	12	3.13	4.27
7/32	.2188	3-3/4	12	3.15	4.30
15/64	.2344	3-7/8	12	3.54	4.83
1/4	.2500	4	12	3.66	4.99
17/64	.2656	4-1/8	12	4.15	5.66
9/32	.2812	4-1/4	6	4.48	6.11
19/64	.2969	4-3/8	6	4.98	6.79
5/16	.3125	4-1/2	6	4.88	6.65
21/64	.3281	4-5/8	6	5.64	7.69
11/32	.3438	4-3/4	6	6.05	8.25
23/64	.3594	4-7/8	6	6.80	9.27
3/8	.3750	5	6	7.13	9.72
25/64	.3906	5-1/8	6	7.77	10.60
13/32	.4062	5-1/4	6	8.42	11.48
27/64	.4219	5-3/8	6	9.43	12.86
7/16	.4375	5-1/2	6	10.38	14.15
29/64	.4531	5-5/8	6	10.94	14.92
15/32	.4688	5-3/4	6	11.12	15.16
31/64	.4844	5-7/8	6	12.61	17.20
1/2	.5000	6	6	12.71	17.33

Specifications				Price Each	
Size	Dec. Equiv.	Overall Length	Pkg. Qty.	Drill Blank 950D	Reamer Blank 950R
33/64	.5156	6	1	22.24	—
17/32	.5312	6	1	23.32	34.07
35/64	.5469	6	1	22.24	—
9/16	.5625	6	1	24.29	35.49
37/64	.5781	6	1	27.85	—
19/32	.5938	6	1	27.85	40.69
39/64	.6094	6	1	27.34	—
5/8	.6250	6	1	27.34	39.94
41/64	.6406	6	1	32.21	—
21/32	.6562	6	1	32.21	47.06
43/64	.6719	6	1	35.30	—
11/16	.6875	6	1	35.30	51.57
45/64	.7031	6	1	35.30	—
23/32	.7188	6	1	35.30	51.57
47/64	.7344	6	1	36.58	—
3/4	.7500	6	1	36.58	53.44
49/64	.7656	6	1	39.92	—
25/32	.7812	6	1	39.92	—
51/64	.7969	6	1	42.52	—
13/16	.8125	6	1	42.52	62.12
53/64	.8281	6	1	47.18	—
27/32	.8438	6	1	47.18	—
55/64	.8594	6	1	50.07	—
7/8	.8750	6	1	50.07	73.15
57/64	.8906	6	1	54.48	—
29/32	.9062	6	1	54.48	—
59/64	.9219	6	1	57.82	—
15/16	.9375	6	1	57.82	84.48
61/64	.9531	6	1	60.13	—
31/32	.9688	6	1	60.13	—
63/64	.9844	6	1	63.36	—
1	1.0000	6	1	63.36	92.57

Wire Gauge Sizes

Specifications				Price Each	
Size	Dec. Equiv.	Overall Length	Pkg. Qty.	Drill Blank 950D	Reamer Blank 950R
A	.2340	3 7/8	12	3.70	5.05
B	.2380	4	12	3.70	5.05
C	.2420	4	12	3.70	5.05
D	.2460	4	12	3.70	5.05
E	.2500	4	12	3.66	4.99
F	.2570	4 1/8	12	4.12	5.62
G	.2610	4 1/8	12	4.12	5.62
H	.2660	4 1/8	12	4.12	5.62
I	.2720	4 1/8	6	4.44	6.05
J	.2770	4 1/8	6	4.44	6.05
K	.2810	4 1/4	6	4.59	6.26
L	.2900	4 1/4	6	4.59	6.26
M	.2950	4 3/8	6	5.12	6.98

Specifications				Price Each	
Size	Dec. Equiv.	Overall Length	Pkg. Qty.	Drill Blank 950D	Reamer Blank 950R
N	.3020	4 3/8	6	5.12	6.98
O	.3160	4 1/2	6	5.06	6.90
P	.3230	4 5/8	6	5.45	7.43
Q	.3320	4 3/4	6	5.45	7.43
R	.3390	4 3/4	6	6.17	8.41
S	.3480	4 7/8	6	7.03	9.59
T	.3580	4 7/8	6	7.03	9.59
U	.3680	5	6	7.46	10.17
V	.3770	5	6	7.46	10.17
W	.3860	5 1/8	6	8.09	11.03
X	.3970	5 1/8	6	8.09	11.03
Y	.4040	5 1/4	6	8.75	11.93
Z	.4130	5 1/4	6	8.75	11.93

Drill & Reamer Blanks

M2 – High Speed Steel

Made from hardened (Rc 63-65) M2 grade High Speed Steel and ground, these Drill and Reamer Blanks can be used as punches, gauges, pins or ground for special tools.



List No. **950D**: Drill Blanks (Up to 1/2" + .0000/ - .0003, over 1/2" + .0000/ - .0005)

List No. **950R**: Reamer Blanks (+.0002/ -.0000, up to 1/2" - over 1/2" +.0005/-.0000)

Wire Gauge Sizes

Specifications				Price Each	
Size	Dec. Equiv.	Overall Length	Pkg. Qty.	Drill Blank 950D	Reamer Blank 950R
1	.2280	3 7/8	12	3.02	4.12
2	.2210	3 7/8	12	3.02	4.12
3	.2130	3 3/4	12	3.02	4.12
4	.2090	3 3/4	12	3.02	4.12
5	.2055	3 3/4	12	3.02	4.12
6	.2040	3 3/4	12	2.90	3.95
7	.2010	3 5/8	12	2.90	3.95
8	.1990	3 5/8	12	2.90	3.95
9	.1960	3 5/8	12	2.90	3.95
10	.1935	3 5/8	12	2.90	3.95
11	.1910	3 1/2	12	2.30	3.14
12	.1890	3 1/2	12	2.30	3.14
13	.1850	3 1/2	12	2.30	3.14
14	.1820	3 3/8	12	2.30	3.14
15	.1800	3 3/8	12	2.30	3.14
16	.1770	3 3/8	12	2.04	2.78
17	.1730	3 3/8	12	2.04	2.78
18	.1695	3 1/4	12	2.04	2.78
19	.1660	3 1/4	12	2.04	2.78
20	.1610	3 1/4	12	2.04	2.78
21	.1590	3 1/4	12	2.04	2.78
22	.1570	3 1/8	12	2.04	2.78
23	.1540	3 1/8	12	2.04	2.78
24	.1520	3 1/8	12	2.04	2.78
25	.1495	3	12	2.04	2.78
26	.1470	3	12	1.82	2.48
27	.1440	3	12	1.82	2.48
28	.1405	2 7/8	12	1.82	2.48
29	.1360	2 7/8	12	1.82	2.48
30	.1285	2 3/4	12	1.82	2.48
31	.1200	2 3/4	12	1.82	2.48
32	.1160	2 3/4	12	1.82	2.48
33	.1130	2 5/8	12	1.82	2.48
34	.1110	2 5/8	12	1.82	2.48
35	.1100	2 5/8	12	1.82	2.48
36	.1065	2 1/2	12	1.82	2.48
37	.1040	2 1/2	12	1.82	2.48
38	.1015	2 1/2	12	1.82	2.48
39	.0995	2 3/8	12	1.82	2.48
40	.0980	2 3/8	12	1.82	2.48

Specifications				Price Each	
Size	Dec. Equiv.	Overall Length	Pkg. Qty.	Drill Blank 950D	Reamer Blank 950R
41	.0960	2 3/8	12	2.31	3.15
42	.0935	2 1/4	12	2.31	3.15
43	.0890	2 1/4	12	2.31	3.15
44	.0860	2 1/8	12	2.31	3.15
45	.0820	2 1/8	12	2.31	3.15
46	.0810	2 1/8	12	2.31	3.15
47	.0785	2	12	2.31	3.15
48	.0760	2	12	2.31	3.15
49	.0730	2	12	2.31	3.15
50	.0700	2	12	2.31	3.15
51	.0670	2	12	2.31	3.15
52	.0635	1 7/8	12	2.31	3.15
53	.0595	1 7/8	12	2.31	3.15
54	.0550	1 7/8	12	2.31	3.15
55	.0520	1 7/8	12	2.31	3.15
56	.0465	1 3/4	12	2.31	3.15
57	.0430	1 3/4	12	2.31	3.15
58	.0420	1 5/8	12	2.31	3.15
59	.0410	1 5/8	12	2.31	3.15
60	.0400	1 5/8	12	2.31	3.15
61	.0390	1 5/8	12	2.31	3.15
62	.0380	1 1/2	12	2.31	3.15
63	.0370	1 1/2	12	2.31	3.15
64	.0360	1 1/2	12	2.31	3.15
65	.0350	1 1/2	12	2.31	3.15
66	.0330	1 3/8	12	2.31	3.15
67	.0320	1 3/8	12	2.31	3.15
68	.0310	1 3/8	12	2.31	3.15
69	.0292	1 3/8	12	2.31	3.15
70	.0280	1 1/4	12	2.31	3.15
71	.0260	1 1/4	12	2.31	3.15
72	.0250	1 1/8	12	2.31	3.15
73	.0240	1 1/8	12	2.31	3.15
74	.0225	1	12	2.31	3.15
75	.0210	1	12	2.31	3.15
76	.0200	7/8	12	2.31	3.15
77	.0180	7/8	12	2.31	3.15
78	.0160	7/8	12	2.31	3.15
79	.0145	3/4	12	2.31	3.15
80	.0135	3/4	12	2.31	3.15

Sets - Drill & Reamer Blanks

Description	Sizes	Pieces	Case Type	Set No.	Price
Drill Blank Set	1/16 – 1/2 by 64 ^{ths}	29	Metal	950SF	175.00
Reamer Blank Set	1/16 – 1/2 by 64 ^{ths}	29	Metal	950SR	235.00
Drill Blank Set	A – Z	26	Metal	950SL	162.11
Drill Blank Set	1 – 60	60	Metal	950SW	150.60
Drill Blank Set	61 – 80	20	Metal	950ST	55.50
Drill Blank Set	1/16 – 1/2 by 64 ^{ths} , A – Z, 1 – 60	115	Metal	950SX	496.48



Metric Drill Blanks

M2 – High Speed Steel

Made from hardened (Rc 63-65) M2 grade High Speed Steel and ground, these Drill and Reamer Blanks can be used as punches, gauges, pins or ground for special tools.



List No. **950D**: Drill Blanks (Up to 1/2" + .0000 / - .0003, over 1/2" + .0000 / - .0005)

Metric Drill Blanks

Size	Dec. Equiv.	Overall Length	Pkg. Qty.	Price Each
1.00	.0394	1 5/8	12	3.37
1.05	.0413	1 5/8	12	3.37
1.10	.0433	1 3/4	12	3.37
1.15	.0453	1 3/4	12	3.37
1.20	.0472	1 7/8	12	3.37
1.25	.0492	1 7/8	12	3.37
1.30	.0512	1 7/8	12	3.37
1.40	.0551	1 7/8	12	3.37
1.45	.0571	1 7/8	12	3.37
1.50	.0590	1 7/8	12	3.37
1.55	.0610	1 7/8	12	3.37
1.60	.0630	1 7/8	12	3.37
1.65	.0650	2	12	3.56
1.70	.0669	2	12	3.56
1.75	.0689	2	12	3.56
1.80	.0709	2	12	3.56
1.85	.0728	2	12	3.56
1.90	.0748	2	12	3.56
1.95	.0768	2	12	3.56
2.00	.0787	2 1/8	12	3.56
2.05	.0807	2 1/8	12	3.56
2.10	.0827	2 1/8	12	3.56
2.15	.0846	2 1/8	12	3.56
2.20	.0866	2 1/4	12	3.56
2.25	.0886	2 1/4	12	3.56
2.30	.0905	2 1/4	12	3.56
2.35	.0925	2 1/4	12	3.56
2.40	.0945	2 3/8	12	3.56
2.45	.0964	2 3/8	12	3.56
2.50	.0984	2 3/8	12	3.56
2.60	.1024	2 1/2	12	3.56
2.70	.1063	2 1/2	12	3.56
2.75	.1083	2 5/8	12	3.56
2.80	.1102	2 5/8	12	3.56
2.90	.1142	2 3/4	12	3.56
3.00	.1181	2 3/4	12	3.56
3.10	.1220	2 3/4	12	3.56
3.20	.1260	2 3/4	12	3.56
3.25	.1279	2 3/4	12	3.72
3.30	.1299	2 7/8	12	3.72
3.40	.1338	2 7/8	12	3.72
3.50	.1378	2 7/8	12	3.72
3.60	.1417	3	12	3.72
3.70	.1457	3	12	4.16
3.75	.1476	3	12	4.16
3.80	.1496	3 1/8	12	4.16
3.90	.1535	3 1/8	12	4.16
4.00	.1575	3 1/4	12	4.16
4.10	.1614	3 1/4	12	4.16
4.20	.1653	3 1/4	12	4.16
4.25	.1673	3 1/4	12	4.16
4.30	.1693	3 1/4	12	4.16
4.40	.1732	3 3/8	12	4.27
4.50	.1772	3 3/8	12	4.27
4.60	.1811	3 3/8	12	4.27
4.70	.1850	3 1/2	12	4.27

Size	Dec. Equiv.	Overall Length	Pkg. Qty.	Price Each
4.75	.1870	3 1/2	12	4.27
4.80	.1890	3 1/2	12	4.27
4.90	.1929	3 5/8	12	5.25
5.00	.1969	3 5/8	12	5.25
5.10	.2008	3 5/8	12	5.25
5.20	.2047	3 3/4	12	5.25
5.25	.2067	3 3/4	12	5.25
5.30	.2087	3 3/4	12	5.25
5.40	.2126	3 3/4	12	5.25
5.50	.2165	3 7/8	12	5.85
5.60	.2205	3 7/8	12	5.85
5.70	.2244	3 7/8	12	5.85
5.80	.2283	3 7/8	12	5.85
5.90	.2323	3 7/8	12	5.85
6.00	.2362	4	12	6.23
6.10	.2401	4	12	6.23
6.20	.2441	4	12	6.23
6.25	.2461	4	12	6.23
6.30	.2480	4	12	6.23
6.40	.2520	4 1/8	12	6.53
6.50	.2559	4 1/8	12	6.53
6.60	.2598	4 1/8	12	6.53
6.70	.2638	4 1/8	12	6.53
6.80	.2677	4 1/8	12	6.53
6.90	.2716	4 1/8	12	6.53
7.00	.2756	4 1/8	12	6.53
7.10	.2795	4 1/4	12	6.83
7.20	.2835	4 1/4	12	6.83
7.30	.2874	4 1/4	12	6.83
7.40	.2913	4 3/8	12	6.83
7.50	.2953	4 3/8	6	7.80
7.60	.2992	4 3/8	6	7.80
7.70	.3031	4 1/2	6	7.80
7.80	.3071	4 1/2	6	7.80
7.90	.3110	4 1/2	6	7.80
8.00	.3150	4 1/2	6	7.80
8.10	.3189	4 5/8	6	8.48
8.20	.3228	4 5/8	6	8.48
8.30	.3268	4 5/8	6	8.48
8.40	.3307	4 3/4	6	9.45
8.50	.3346	4 3/4	6	9.45
8.60	.3386	4 3/4	6	9.45
8.70	.3425	4 3/4	6	9.45
8.80	.3464	4 7/8	6	10.43
8.90	.3504	4 7/8	6	10.43
9.00	.3543	4 7/8	6	10.43
9.10	.3583	4 7/8	6	10.43
9.20	.3655	5	6	11.40
9.30	.3661	5	6	11.40
9.40	.3701	5	6	11.40
9.50	.3740	5	6	11.40
9.60	.3779	5 1/8	6	12.00
9.70	.3819	5 1/8	6	12.00
9.80	.3858	5 1/8	6	12.00
9.90	.3898	5 1/8	6	12.00
10.00	.3937	5 1/8	6	12.00

Size	Dec. Equiv.	Overall Length	Pkg. Qty.	Price Each
10.10	.3976	5 1/4	6	12.98
10.20	.4016	5 1/4	6	12.98
10.30	.4055	5 1/4	6	12.98
10.40	.4094	5 1/4	6	12.98
10.50	.4134	5 3/8	6	14.33
10.60	.4173	5 3/8	6	14.33
10.70	.4212	5 3/8	6	14.33
10.80	.4252	5 1/2	6	16.28
10.90	.4291	5 1/2	6	16.28
11.00	.4331	5 1/2	6	16.28
11.10	.4370	5 1/2	6	16.28
11.20	.4409	5 5/8	6	16.88
11.30	.4449	5 5/8	6	16.88
11.40	.4488	5 5/8	6	16.88
11.50	.4527	5 5/8	6	16.88
11.60	.4567	5 3/4	6	17.25
11.70	.4606	5 3/4	6	17.25
11.80	.4646	5 3/4	6	17.25
11.90	.4685	5 3/4	6	17.25
12.00	.4724	5 7/8	6	19.50
12.10	.4764	5 7/8	6	19.50
12.20	.4803	5 7/8	6	19.50
12.30	.4842	5 7/8	6	19.50
12.40	.4882	5 7/8	6	19.50
12.50	.4921	6	6	20.78
12.60	.4961	6	1	20.78
12.70	.5000	6	1	20.78
12.80	.5039	6	1	24.38
12.90	.5079	6	1	26.33
13.00	.5118	6	1	28.89
13.50	.5315	6	1	31.20
14.00	.5512	6	1	31.80
14.50	.5709	6	1	34.73
15.00	.5906	6	1	35.10
15.50	.6102	6	1	38.63
16.00	.6299	6	1	39.60
16.50	.6496	6	1	42.23
17.00	.6693	6	1	45.75
17.50	.6890	6	1	46.73
18.00	.7087	6	1	49.35
18.50	.7283	6	1	51.30
19.00	.7480	6	1	51.30
19.50	.7677	6	1	55.20
20.00	.7874	6	1	56.18
20.50	.8071	6	1	57.15
21.00	.8268	6	1	61.05
21.50	.8465	6	1	62.33
22.00	.8661	6	1	64.28
22.50	.8858	6	1	68.85
23.00	.9055	6	1	71.55
23.50	.9252	6	1	72.08
24.00	.9449	6	1	75.66
24.50	.9646	6	1	77.25
25.00	.9843	6	1	81.83
25.40	1.0000	6	1	81.83

Sets - Metric Drill Blanks

Description	Sizes	Pieces	Case Type	Set No.	Price
Drill Blank Set	1.00 – 13.00 by .50mm	25	Metal	950SD	256.30





LAVALLEE & IDE

The Reamer Specialists

SPECIAL REAMER REQUEST FORM

Please fill out the following form for a quote on Special Reamers.

1. Make a copy of this form.
2. Fill in the specifications.
3. Fax or e-mail to your Lavallee & Ide Distributor.

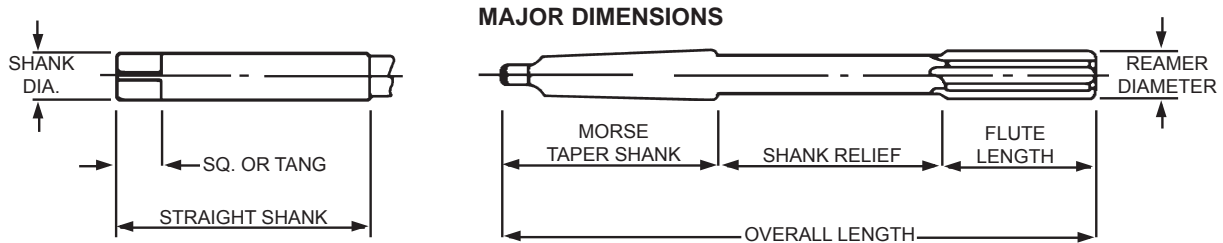

TYPICAL END CUTS



STANDARD LEAD CHAMFER



END CUTTING TO FLUTE DEPTH



END CUTTING TO CENTER HOLE



FULLY END CUTTING

* All unspecified Dimensions & Tolerances to standard manufacturing specifications.

Quantity: _____

*Quantity is subject to 10% overage or shortage.
±1 piece for orders less than 10 pieces.

Material: H.S. Cobalt Solid Carbide Carbide Tipped

Reamer Diameter: _____ Coating _____

Direction of Cut: Straight Flute Right Hand Cut Right Hand Spiral Right Hand Cut Left Hand Spiral Right Hand Cut

Length of Flute: _____ Number of Flutes: _____ Overall Length: _____

Shank Diameter: Standard _____ Reduced Shank _____ Length of Reduced Shank _____

Shank: Straight _____ Tanged _____ Square _____ Morse Taper _____ Threaded Hex _____

Non-Cutting _____ Pilot Diameter (non-cutting) _____ Pilot Length _____

Cutting _____ Step Diameter (cutting) _____ Step Length _____



LAVALLEE & IDE

The Reamer Specialists

SPECIAL TAPER FLUTED REAMER REQUEST FORM

Please fill out the following form for a quote on Special Reamers.

1. Make a copy of this form.
2. Fill in the specifications.
3. Fax or e-mail to your Lavallee & Ide Distributor.

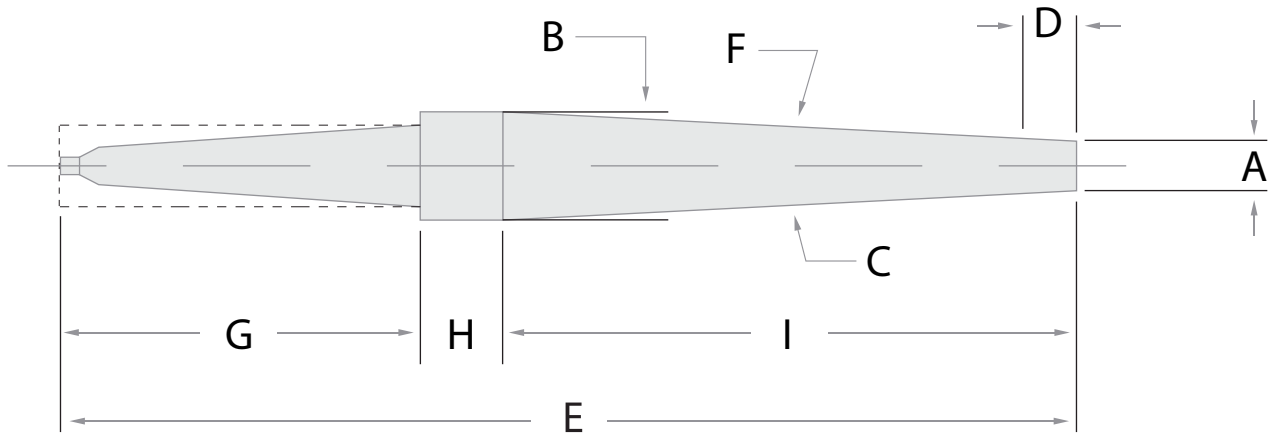

*All unspecified Dimensions & Tolerances to standard manufacturing specifications.

Quantity*: _____ *Quantity is subject to 10% overage or shortage.
±1 piece for orders less than 10 pieces.

Material: H.S. Cobalt Carbide Tipped Coating: _____

"F" Flute Type: Straight Flute Right Hand Cut Right Hand Spiral Right Hand Cut Left Hand Spiral Right Hand Cut

"G" Shank Type: Morse Taper #: _____ Round: _____ Square: _____ Other: _____

Letter	Description	Measurements
A	Diameter Small/Point End	-----
B	Diameter Large/Shank End	-----
C	Taper per Ft./Taper per Inch/Included Angle	-----
D	Length & Angle of Chamfer	-----
E	Overall Length	-----
H	Neck Length	-----
I	Flute Length	-----
Number Of Flutes		-----



LAVALLEE & IDE
The Reamer Specialists

SPECIAL STEP REAMER REQUEST FORM

Please fill out the following form for a quote on Special Reamers.

1. Make a copy of this form.
2. Fill in the specifications.
3. Fax or e-mail to your Lavallee & Ide Distributor.

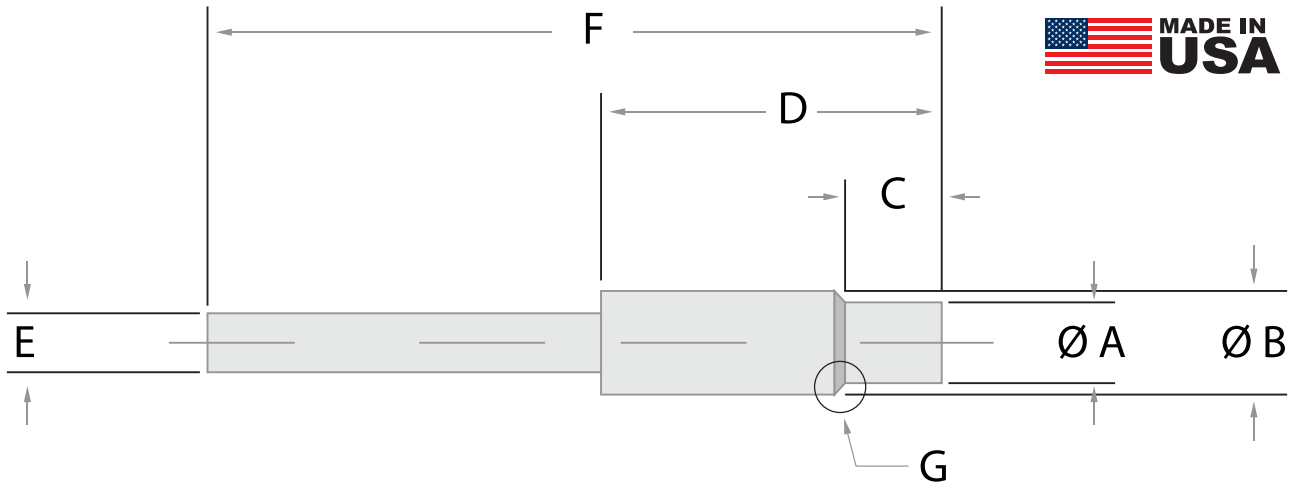

* All unspecified Dimensions & Tolerances to standard manufacturing specifications.

Quantity*: _____ *Quantity is subject to 10% overage or shortage.
 ± 1 piece for orders less than 10 pieces.

Material: H.S. Cobalt Carbide Tipped Coating: _____

Flute Type: Straight Flute Right Hand Spiral Left Hand Spiral
 Right Hand Cut Right Hand Cut Right Hand Cut

"A": Minor Diameter: Pilot (Non-Cutting) Step (Cutting)

Letter	Description	Measurements
A	Minor Diameter	-----
B	Cutting (Major) Diameter	-----
C	Pilot/Step Length	-----
D	Flute Length	-----
E	Shank Diameter/Morse Taper Size	-----
F	Overall Length	-----
G	Chamfer/Shoulder Angle	-----
Number Of Flutes		-----

Reamer Sets

These sets provide a method of maintaining a complete stock of reamers in ranges to suit your requirements. They have particular benefits in tool and die shops where they save time and energy. A set on a machinist's workbench saves many trips to the tool crib. They are available in handsome wooden cases, metal index boxes, and vinyl plastic in many styles and size ranges.



Chucking Reamer Sets

Description	Sizes	Pieces	Case Type	Set No.	Price
H.S. Straight Flute	1/16 – 1/4 by 64 ^{ths}	13	Wood	LV533-6W	264.67
H.S. Straight Flute	1/16 – 1/4 by 64 ^{ths}	13	Plastic	LV533-6P	207.67
H.S. Straight Flute	1/16 – 1/2 by 32 ^{nds}	15	Plastic	LV533-42P	309.92
H.S. Straight Flute	1/16 – 3/8 by 64 ^{ths}	21	Plastic	LV533-40P	388.22
H.S. Straight Flute	1/16 – 1/2 by 64 ^{ths}	29	Wood	LV533-8W	664.72
H.S. Straight Flute	1/16 – 1/2 by 64 ^{ths}	29	Plastic	LV533-8P	607.72
H.S. Straight Flute	1/16 – 1/2 by 64 ^{ths}	29	Metal	LV533-8M	630.22
H.S. RH Spiral	1/16 – 1/4 by 64 ^{ths}	13	Wood	LV535-1W	298.90
H.S. RH Spiral	1/16 – 1/4 by 64 ^{ths}	13	Plastic	LV535-1P	241.90
H.S. RH Spiral	1/16 – 1/2 by 32 ^{nds}	15	Plastic	LV535-43P	352.33
H.S. RH Spiral	1/16 – 3/8 by 64 ^{ths}	21	Plastic	LV535-41P	438.83
H.S. RH Spiral	1/16 – 1/2 by 64 ^{ths}	29	Wood	LV535-3W	740.93
H.S. RH Spiral	1/16 – 1/2 by 64 ^{ths}	29	Metal	LV535-3M	706.43
H.S. RH Spiral	1/16 – 1/2 by 64 ^{ths}	29	Plastic	LV535-3P	683.93
H.S. LH Spiral	1/16 – 1/2 by 64 ^{ths}	29	Wood	LV535L-4W	821.40
H.S. LH Spiral	1/16 – 1/2 by 64 ^{ths}	29	Plastic	LV535L-4P	764.40
Cobalt Straight Flute	1/16 – 1/2 by 64 ^{ths}	29	Wood	1533-C8W	1027.00
Cobalt Straight Flute	1/16 – 1/2 by 64 ^{ths}	29	Metal	1533-C8M	992.50
Cobalt Straight Flute	1/16 – 1/2 by 64 ^{ths}	29	Plastic	1533-C8P	970.00
Cobalt RH Spiral	1/16 – 1/2 by 64 ^{ths}	29	Wood	1535-C3W	1068.47
Cobalt RH Spiral	1/16 – 1/2 by 64 ^{ths}	29	Metal	1535-C3M	1033.97
H.S. Straight Flute	#1 – #60	60	Wood	LV533-13W	987.00
H.S. Straight Flute	#1 – #60	60	Metal	LV533-13M	945.00
H.S. Straight Flute	#1 – #60	60	Plastic	LV533-13P	931.57
H.S. Straight Flute	#61 – #80	20	Metal	LV533-15M	348.75
H.S. RH Spiral	#1 – #60	60	Wood	LV535-10W	1113.90
H.S. RH Spiral	#1 – #60	60	Metal	LV535-10M	1084.60
H.S. RH Spiral	#1 – #60	60	Plastic	LV535-10P	1059.47
H.S. LH Spiral	#1 – #60	60	Wood	LV535L-11W	1247.70
H.S. LH Spiral	#1 – #60	60	Plastic	LV535L-11P	1192.27
Cobalt Straight Flute	#1 – #60	60	Wood	1533-C13W	1319.50
Cobalt Straight Flute	#1 – #60	60	Metal	1533-C13M	1227.50
Cobalt Straight Flute	#1 – #60	60	Plastic	1533-C13P	1264.07
H.S. Straight Flute	A – Z	26	Wood	LV533-23W	651.85
H.S. Straight Flute	A – Z	26	Metal	LV533-23M	617.35
H.S. Straight Flute	A – Z	26	Plastic	LV533-23P	594.85
Cobalt Straight Flute	A – Z	26	Wood	1533-C23W	983.50
Cobalt Straight Flute	A – Z	26	Metal	1533-C23M	949.00
Cobalt Straight Flute	A – Z	26	Plastic	1533-C23P	926.50
H.S. Straight Flute	1mm – 7mm by .5	13	Wood	LV533-16W	238.60
H.S. Straight Flute	1mm – 7mm by .5	13	Plastic	LV533-16P	181.60
H.S. Straight Flute	1mm – 13mm by .5	25	Plastic	LV533-17P	542.25
H.S. Straight Flute	.1240 – .5010	14	Wood	LV533-32W	357.70
H.S. Straight Flute	.1240 – .5010	14	Metal	LV533-32M	323.20
H.S. Straight Flute	.1240 – .5010	14	Plastic	LV533-32P	300.70
H.S. RH Spiral	.1240 – .5010	14	Wood	LV535-30W	399.50
H.S. RH Spiral	.1240 – .5010	14	Plastic	LV535-30P	342.50
H.S. LH Spiral	.1240 – .5010	14	Wood	LV535L-31W	447.00
H.S. LH Spiral	.1240 – .5010	14	Plastic	LV535L-31P	390.00
Cobalt Straight Flute	.1240 – .5010	14	Wood	1533-C32W	544.50
Cobalt Straight Flute	.1240 – .5010	14	Plastic	1533-C32P	487.50
Cobalt RH Spiral	.1240 – .5010	14	Wood	1535-C32W	566.80
Cobalt RH Spiral	.1240 – .5010	14	Plastic	1535-C32P	509.80



LV533-6W



LV533-8M



LV533-42P

Expansion Hand Reamer Sets

Sizes	Description	Pieces	Part No.	Price
1/4, 3/8, 1/2, 5/8, 3/4	Straight Flute	5	576US	967.67
1/4, 3/8, 1/2, 5/8, 3/4	LH. Spiral/ RH. Cut	5	577US	1091.67



Supplied in Wood Block

Reamer Sets



Dowel Pin Reamer Sets

14 piece sets, sizes .1230 to .4995 * Drills are 1/64 smaller than Reamers

Description	Flute Type	Case Type	Set No.	Price
H.S. Standard Length	Straight	Wood	LV570-70W	357.50
H.S. Standard Length	Straight	Plastic	LV570-70P	318.50
Cobalt Standard Length	Straight	Wood	1570DP-W	491.00
Cobalt Standard Length	Straight	Plastic	1570DP-P	434.00
H.S. Standard Length	RH Spiral	Wood	LV575-71W	422.30
H.S. Standard Length	RH Spiral	Plastic	LV575-71P	365.30
Cobalt Standard Length	RH Spiral	Wood	1575DP-W	523.40
Cobalt Standard Length	RH Spiral	Plastic	1575DP-P	466.40
H.S. Jobber Length	Straight	Plastic	LVDL570-73P	305.36
H.S. Jobber Length	RH Spiral	Plastic	LVDL575-74P	345.10



1570DP-W

Production/CNC/Jobber Length Reamer Sets

Description	Sizes	Pieces	Case Type	Set No.	Price
H.S. Straight Flute	1/16 – 1/4 by 64 ^{ths}	13	Metal	LVDL533-5M	190.67
H.S. Straight Flute	1/16 – 1/2 by 32 ^{nds}	15	Metal	LVDL533-46M	292.44
H.S. Straight Flute	1/16 – 1/2 by 64 ^{ths}	29	Metal	LVDL533-7M	590.69
H.S. RH Spiral	1/16 – 1/2 by 32 ^{nds}	15	Metal	LVDL535-47M	328.84
H.S. RH Spiral	1/16 – 1/2 by 64 ^{ths}	29	Metal	LVDL535-9M	626.91
H.S. Straight Flute	#1 – #60	60	Metal	LVDL533-12M	847.50
H.S. RH Spiral	#1 – #60	60	Metal	LVDL535-14M	953.47
H.S. Straight Flute	A – Z	26	Metal	LVDL533-22M	556.22
H.S. RH Spiral	A – Z	26	Metal	LVDL535-24M	595.77
H.S. Straight Flute	.1240 – .5010	14	Plastic	LVDL533-33P	289.94
H.S. RH Spiral	.1240 – .5010	14	Plastic	LVDL535-34P	309.78
H.S. Straight Flute	#1 – #60, A – Z, 1/16 – 1/2 by 64 ^{ths}	115	Metal	LVDL533-50M	1988.84
H.S. RH Spiral	#1 – #60, A – Z, 1/16 – 1/2 by 64 ^{ths}	115	Metal	LVDL535-51M	2172.92

Silver & Deming Reamer Sets

Sizes	Description	Pieces	Set No.	Price
5/8, 11/16, 3/4, 13/16, 7/8, 1	1/2" Shank Reamer Set	6	LV75	400.14
5/8, 11/16, 3/4, 13/16, 7/8, 1 (Reamers) 39/64, 43/64, 47/64, 51/64, 55/64, 63/64 (Drills)	1/2" Shank Reamer & Drill Set	12	LV77	589.64
5/8, 11/16, 3/4, 13/16, 7/8 1, 1 1/8, 1 1/4, 1 3/8, 1 1/2	1/2" Shank Reamer Set	10	LV76	1022.56

Supplied in Wood Block



LV75



LV77

Taper Pin Reamer Sets

Sizes	Description	Pieces	Part No.	Price
7/0, 6/0, 5/0, 4/0, 3/0, 2/0, 0, 1, 2, 3, 4, 5, 6, 7, 8, 9, 10	Straight Flute	17	556USA	780.12
0, 1, 2, 3, 4, 5, 6, 7, 8, 9, 10	Straight Flute	11	556USB	559.11
7/0, 6/0, 5/0, 4/0, 3/0, 2/0, 0, 1, 2, 3, 4, 5, 6, 7, 8, 9, 10	Left Hand Spiral	17	557USA	845.55
0, 1, 2, 3, 4, 5, 6, 7, 8, 9, 10	Left Hand Spiral	11	557USB	611.58
7/0, 6/0, 5/0, 4/0, 3/0, 2/0, 0, 1, 2, 3, 4, 5, 6, 7, 8, 9, 10	Left Hand Helical Flute	17	558USA	915.14
0, 1, 2, 3, 4, 5, 6, 7, 8, 9, 10	Left Hand Helical Flute	11	558USB	675.16

Aligning, Construction, Morse Taper, and Brown & Sharpe Sets

Description	Sizes	Pieces	Part No.	Price
H.S. Aligning Reamers	1/2, 9/16, 5/8, 3/4	4	535RS	237.40
Cobalt Aligning Reamers	1/2, 9/16, 5/8, 3/4	4	535RCS	303.09
H.S. Construction Reamers	1/2, 9/16, 5/8, 3/4	4	583CRS	299.76
H.S. Morse Taper Reamers	#1 – #5	5	568US	821.00
H.S. Brown & Sharpe Taper Reamers	#1 – #5	5	596US	436.25

Reaming Recommendations



Work piece hardness and machinability must be considered when setting machine speed.

The feed rate plays an important part in the life expectancy of a tool and the hole finish which one is looking to attain. Improper feed rate can cause excessive tool wear as well as an inadequate hole finish.

Excessive tool wear and hole finish can be a result of all of the above.

To eliminate chatter, slow cutting speed and increase feed appropriately.

Stock removal on roughing operations should not exceed 2% to 4% of tool diameter in most cases.

Stock removal recommendations on finishing operations are .002 to .004.

For best results with brass, cast iron and some plastics, use a left-hand spiral-fluted reamer with negative shear action. This type of reamer helps prevent chips from working back into spiral flutes and scoring the hole.

In all reaming operations, use constant-flow coolants. Soluble oil is effective for most metals; however, sulphur-based oils are recommended for stainless and certain alloy steels. Lard oil and kerosene improve the finish on aluminum.

Hole preparation may affect reamer performance due to work hardening.

Recommended Stock Removal

Reamer Diameter	Removal (Inches)
Up to 1/16 Incl.	.003 to .005
Over 1/16 to 1/8 Incl.	.004 to .008
Over 1/8 to 1/4 Incl.	.006 to .012
Over 1/4 to 3/8 Incl.	.008 to .014
Over 3/8 to 1/2 Incl.	.010 to .015
Over 1/2 to 3/4 Incl.	.012 to .018

Recommended Feeds

Material	Feed in Inches Per Revolution
Steels	
Rockwell C50 or Harder	.002 to .004
Rockwell C30 to 50	.004 to .008
Cast Iron & Malleable Iron	.005 to .012
Non-Ferrous Materials	.005 to .012

Recommended Speeds

Material	Speed in Surface Feet Per Minute
Steel (All Types)	
Rockwell C60 or Harder	8 - 12
Rockwell C50 to 60	15 - 30
Rockwell C40 to 50	20 - 40
Rockwell C30 to 40	35 - 65
Under Rockwell C30	60 - 90
Cast Iron and Malleable Iron	50 - 85
Non-Ferrous	
Aluminum, Brass, Bronze, Copper, Fiber, Plastic, Hard Rubber, etc.	90 - 175

Recommended Lubricants

Material	Lubricant
Steel harder than Rockwell C50	Light Oil
Steel softer than Rockwell C50	Light Oil For Good Finishes or Soluble Oil and Water
Cast Iron & Malleable Iron	Soluble Oil and Water
Non-Ferrous Materials	Soluble Oil and Water

All Dimensions in Inches

Product Line

- Chucking Reamers & Sets
- Dowel Pin Reamers & Sets
- Dowel Pin Reamers Jobber Length & Sets
- Decimal Chucking Reamers
- Jobber Length Reamers & Sets
- Extra Long Chucking Reamers
- Silver & Deming Reamers & Sets
- Adjustable Hand Reamers
- Solid Carbide Chucking Reamers
- Carbide Tipped Chucking Reamers
- Hand Reamers
- Metric Hand Reamers
- Expansion Hand Reamers & Sets
- Expansion Chucking Reamers
- Taper Shank Chucking Reamers
- Taper Shank Jobber Reamers
- Bridge Reamers
- Car Reamers - Short Body
- Aligning Reamers & Sets
- Hex Nut Shank Style Aligning Reamers
- Construction Aligning Reamers & Sets
- Taper Pin Reamers & Sets
- Metric Taper Pin Reamers
- Morse Taper Roughing and Finishing Reamers & Sets
- Brown & Sharpe Taper Reamers & Sets
- Jarno Taper Reamers
- Shell Reamers
- Carbide Tipped Shell Reamers
- Shell Reamer Arbors
- E-Z Eject Shell Reamer Arbors
- Taper Pipe Reamers
- Stub Screw Machine Reamers
- Combination Drill & Reamer - DROLLER®
- Reamer Sets



Price: \$5.00



L & I LAVALLEE & IDE

Division of the Republic Group:



Scan QR Code to browse this catalog right from your smartphone

1889 Larchwood Dr. Troy, MI. 48083

Phone: (248) 989-0303

Fax: (248) 989-0356

Toll Free: 1 (800) 451-5195

Email: sales@lavallee-ide.com

www.lavallee-ide.com

1166 E. Ash Ave. Fullerton, CA. 92831

Phone: (714) 441-5394

Fax: (714) 441-5395

Toll Free: 1 (800) 858-6382

Email: sales@a-1supply.com