



*The First Choice*  
TECHNOLOGY

# Knurling Tools

for Cutting & Forming



Section: H of 2016 Indexable Cutting Tools

## Knurling Tools & Wheels

### Technical Support

Knurling Tools Applications Form for Manual & CNC Machines .....  
Knurling Tools Terminology .....  
Knurling Tools Technical Data .....  
Knurling Tools Tooth & Pitch Calculations .....  
Knurling Pattern Information .....  
Knurling Tools Proper Print Dimensions .....  
Knurling Tools Diametral Knurling Information .....  
Knurling Tools Knurled Diameters .....  
Knurling Tools Speeds & Feeds .....  
Common Knurling Problems .....  
Knurling Tools Forming Operation Instructions .....  
Knurling Tools Cutting Operation Instructions .....  
Application for Clean, Well-formed Knurl or Serrations .....  
Mathematical Conversion Factors .....  
Metric Conversion Formula and Tables .....  
Safety Precautions & Product Hazards .....

### Knurling Tools For CNC and Manual Lathes

Graphic Index .....  
Knurling Tools Identification Chart .....

### Knurl Wheels

Knurling Wheels Identification System .....  
Knurling Wheels Technology .....  
Knurling Wheels Series Selection .....

### Knurling Tools Spare Parts

Spare Parts .....



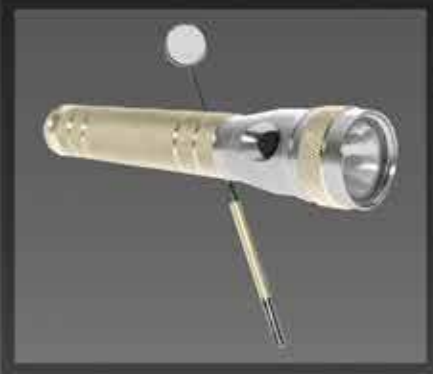

The Possibilities are **ENDLESS** with

**DORIAN<sup>®</sup>**  
**TOOL**

# Knurling Tools



# Knurling Tools & Wheels

|   |  |   |   |
|---|--|---|---|
| <p><b>CNC Modular</b><br/>Shank for Standard Series Modular Knurling Heads</p>  <p>Page H-28</p>   | <p><b>CNC Modular</b><br/>Shank for SMALL Series Modular Knurling Heads</p>  <p>Page H-32</p>     | <p><b>SWFKT</b><br/>Single Wheel Fixed Knurling Tool<br/><b>HDSWFKT</b><br/>Heavy Duty Single Wheel Fixed Knurling Tool</p>  <p>Page H-40</p> | <p><b>KTM109</b><br/>Heavy Duty Style Straddle Square Shank Knurling Tool<br/>1.5" &amp; 2.5" Diameter Range</p>  <p>Page H-48<br/>(See page for Interchangeable Arms)</p> |
| <p><b>CNC-1-2</b><br/>1 - Light Duty 60° Diamond Cutting Knurling Head</p>  <p>Page H-28</p>       | <p><b>SCNC-1-2</b><br/>1-SMALL Light Duty 60° Diamond Cutting Knurling Head</p>  <p>Page H-33</p> | <p><b>SSWFKT</b><br/>Single Shoulder Wheel Fixed Knurling Tool</p>  <p>Page H-42</p>  | <p><b>KTW109</b><br/>Shoulder Style Straddle Square Shank Knurling Tool<br/>1.5" &amp; 2.5" Diameter Range</p>  <p>Page H-49<br/>(See page for Interchangeable Arms)</p>   |
| <p><b>CNC-2-R</b><br/>2 - Heavy Duty 60° Diamond Cutting Knurling Head</p>  <p>Page H-28</p>       | <p><b>SCNC-6-2</b><br/>6- SMALL Shoulder Forming Knurling Head</p>  <p>Page H-33</p>              | <p><b>FKT</b><br/>Fixed Knurling Tool</p>  <p>Page H-41</p>   | <p><b>KTO109</b><br/>Heavy Duty Style Straddle Square Shank Knurling Tool<br/>4.0" Diameter</p>  <p>Page H-50<br/>(See page for Interchangeable Arms)</p>                  |
| <p><b>CNC-3-M</b><br/>3 - Extra Heavy Duty 60° Diamond Cutting Knurling Head</p>  <p>Page H-28</p> | <p><b>SCNC-7-D</b><br/>7- SMALL Straddle Forming Knurling Head</p>  <p>Page H-33</p>              | <p><b>SFKT</b><br/>Shoulder Fixed Knurling Tool</p>  <p>Page H-43</p>   | <p><b>KTW109-40</b><br/>Shoulder Style Straddle Square Shank Knurling Tool<br/>4.0" Diameter Range</p>  <p>Page H-51<br/>(See page for Interchangeable Arms)</p>           |
| <p><b>CNC-4-M</b><br/>4- Double Wheel Forming Knurling Head</p>  <p>Page H-29</p>                | <p><b>SCNC-8-2</b><br/>7- SMALL Straddle Forming Knurling Head</p>  <p>Page H-33</p>            | <p><b>SCKN</b><br/>Self Centering Knurling Tool<br/><b>HDSCKN</b><br/>Heavy Duty Self Centering Knurling Tool</p>  <p>Page H-38</p>         | <p><b>CNC109-M</b><br/>Side Mount Flange Square Shank Knurling Tool<br/>1.5 &amp; 2.5 Diameter Range</p>  <p>Page H-52<br/>(See page for Interchangeable Arms)</p>        |
| <p><b>CNC-5-O</b><br/>5- Single Wheel Forming Knurling Head</p>  <p>Page H-29</p>                | <p><b>107ST</b><br/>Straight Cutting Knurling Tool</p>  <p>Page H-34</p>                        | <p><b>SSCK</b><br/>Shoulder Self Centering Knurling Tool</p>  <p>Page H-39</p>  | <p><b>CNC109-4</b><br/>Side Mount Shoulder Square Shank Knurling Tool<br/>1.5 &amp; 2.5 Diameter Range</p>  <p>Page H-53<br/>(See page for Interchangeable Arms)</p>     |
| <p><b>CNC-6-4</b><br/>6- Shoulder Forming Knurling Head</p>  <p>Page H-29</p>                    | <p><b>107ST</b><br/>Straight Cutting Shoulder Knurling Tool</p>  <p>Page H-35</p>               | <p><b>TIKT</b><br/>True Internal Knurling Tool</p>  <p>Page H-44</p>  | <p><b>3WKT</b><br/>Three Wheel Knurling Tool</p>  <p>Page H-57</p>   |
| <p><b>CNC-7-R</b><br/>7- Straddle Forming Knurling Head</p>  <p>Page H-29</p>                    | <p><b>3SHKT</b><br/>Three Swivel Head Forming Knurling Tool</p>  <p>Page H-37</p>               | <p><b>SIKT</b><br/>Shoulder Internal Knurling Tool</p>  <p>Page H-45</p>  | <p><b>Knurling Wheels</b></p>  <p>Page H-60</p>  |
| <p><b>CNC-8-2</b><br/>7- Straddle Forming Knurling Head</p>  <p>Page H-29</p>                    | <p><b>FACEKT</b><br/>Single Wheel Face Forming Knurling Tool</p>  <p>Page H-36</p>              | <p><b>MMKT</b><br/>Milling Machine Knurling Tool</p>  <p>Page H-46</p>  | <p><b>Spare Parts</b></p>  <p>Page H-71</p>  |



# Knurling Tools Applications Form for Manual & CNC Machines

If your knurling application is not in the chart, please supply prints and information.

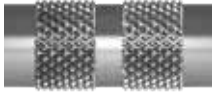

## Knurling Application      Knurling Tool Recommendation

| Diamond Shoulderless<br> | BEST       | BETTER     | GOOD         |
|--|------------|------------|--------------|
|  | SCNC-_-1-2 | SCNC-_-7-D | SCKN-_-DW-_- |
|  | CNC-_-1-2  | CNC-_-7-R  | 3SHKT-_-     |
|  | CNC-_-2-R  | KTM109-_-M | CNC-_-4-M    |
|  | CNC-_-3-M  | KTO109-_-O |              |
| 3WKT-_-  | 3SHKT-_-   |            |              |

| Diamond to a Shoulder<br> | BEST       | BETTER    | GOOD         |
|---|------------|-----------|--------------|
|   | SCNC-_-6-2 | KT109-_-4 | SCCK-_-DW-_- |
|   | CNC-_-6-4  |           | KTM-109-_-M  |
|   | 3WKT-_-    |           |              |

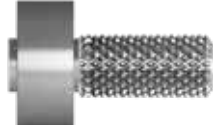
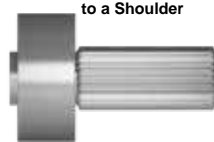
| Diamond Band<br>  | BEST       | BETTER       | GOOD    |
|---|------------|--------------|---------|
|   | SCNC-_-7-D | SCKN-_-DW-_- | SFKT-_- |
|   | CNC-_-7-R  | 3SHKT-_-     | SWKT-_- |
|   | KTM109-_-M |              |         |
|   | KTO109-_-O |              |         |
| Straight Band<br> | CNC-_-4-M  |              |         |
|   | CNC-_-5-O  |              |         |

| Small Diameter Diamond to a Shoulder<br>  | BEST    | BETTER | GOOD |
|---|---------|--------|------|
|   | 3WKT-_- |        |      |
| Small Diameter Straight to a Shoulder<br> |         |        |      |

| Diamond Crest<br>  | BEST       | BETTER       | GOOD    |
|--|------------|--------------|---------|
|  | SCNC-_-7-D | SCKN-_-DW-_- | SFKT-_- |
|  | CNC-_-7-R  | 3SHKT-_-     | SWKT-_- |
|  | KTM109-_-M |              |         |
|  | CNC-_-4-M  |              |         |
| Straight Crest<br> | CNC-_-5-O  |              |         |



| Radio Face<br> | BEST    | BETTER | GOOD |
|--|---------|--------|------|
|  | Special |        |      |



## Knurling Application      Knurling Tool Recommendation

| Straight Shoulderless<br> | BEST       | BETTER       | GOOD      |
|---|------------|--------------|-----------|
|   | SCNC-_-7-D | 107ST-_-     | CMC-_-5-O |
|   | CNC-_-7-R  | 107ST-_-     | SWKT-_-   |
|   | KTM109-_-M | CNC-_-4-M    |           |
|   | KTO109-_-O | SCKN-_-DW-_- |           |
| 3WKT-_-   |            |              |           |

| Straight to a Shoulder<br> | BEST       | BETTER     | GOOD   |
|--|------------|------------|--------|
|  | KTW109-_-4 | SCNC-_-6-2 | FKT-_- |
|  | 3WKT-_-    | CNC-_-6-4  |        |

| Small Diameter Diamond Shoulderless<br>  | BEST      | BETTER     | GOOD    |
|--|-----------|------------|---------|
|  | 3WKT-_-   | SCNC-_-7-D | SFKT-_- |
| Small Diameter Straight Shoulderless<br> | CNC-_-7-R | SWFKT-_-   |         |

| Taper Diamond<br>  | BEST    | BETTER | GOOD |
|--|---------|--------|------|
|  | Special |        |      |
| Taper Straight<br> |         |        |      |

| Internal Diamond<br>  | BEST    | BETTER | GOOD |
|---|---------|--------|------|
|   | TIKT-_- |        |      |
|   | SIKT-_- |        |      |
| Internal Straight<br> |         |        |      |

| Milling Diamond<br>  | BEST    | BETTER | GOOD |
|--|---------|--------|------|
|  | MMKT-_- |        |      |
| Milling Straight<br> |         |        |      |

**Figure 1 - Full Knurling**

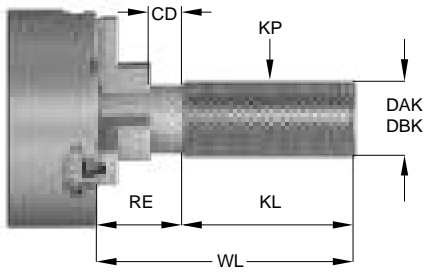

**Figure 2 - Band Knurling**

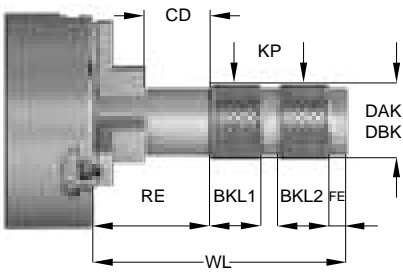

**Figure 3 - Shoulder Knurling**

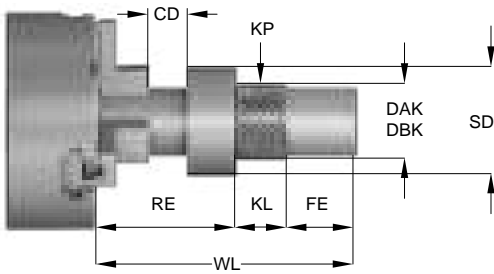

**Figure 4 - Crest Knurling**

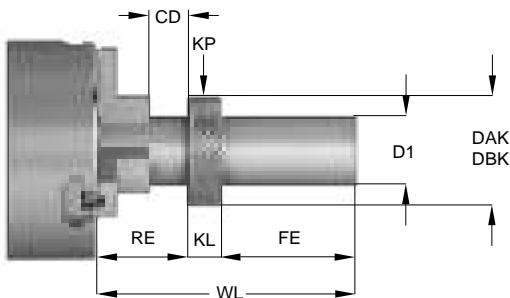

**Knurl Wheel Identification**

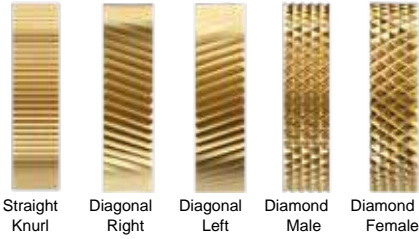

**Edge Prep**

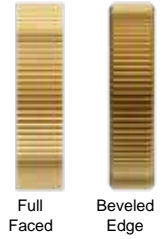

**Knurl Pitch**

**TPI** Is the number of teeth per inch

**Circular Pitch** Is the distance between tooth to tooth

**Diametral Pitch** Is the number of teeth per inch of diameter

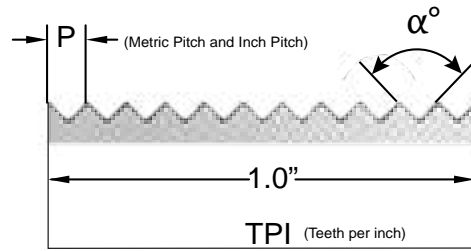

**Knurling Specification**

x Check Knurling Specification

- |                                  |                          |                                  |                          |
|----------------------------------|--------------------------|----------------------------------|--------------------------|
| <b>SKP</b> Straight Knurl        | <input type="checkbox"/> | <b>DKPM</b> Diamond Knurl Male   | <input type="checkbox"/> |
| <b>DKPR</b> Diagonal Knurl Right | <input type="checkbox"/> | <b>DKPF</b> Diamond Knurl Female | <input type="checkbox"/> |
| <b>DKPL</b> Diagonal Knurl Left  | <input type="checkbox"/> |                                  |                          |

Fill Knurling Dimension

- |   |                                 |                               |                          |                            |                          |
|---|---------------------------------|-------------------------------|--------------------------|----------------------------|--------------------------|
| <b>KP</b> Knurl Pitch                       | <input type="checkbox"/> Inch   | <input type="checkbox"/> TPI  | <input type="checkbox"/> | <b>AP</b> % of Knurl Depth | <input type="checkbox"/> |
|   |                                 | <input type="checkbox"/> DP   | <input type="checkbox"/> |                            |                          |
|   | <input type="checkbox"/> Metric | <input type="checkbox"/> P-mm | <input type="checkbox"/> |                            |                          |
| <b>DBK</b> Diameter (Blank) Before Knurling | <input type="checkbox"/>        | <b>FE</b> Front End Distance  | <input type="checkbox"/> |                            |                          |
| <b>DAK</b> Diameter After Knurling          | <input type="checkbox"/>        | <b>RE</b> Rear End Distance   | <input type="checkbox"/> |                            |                          |
| <b>KL</b> Knurling Length                   | <input type="checkbox"/>        | <b>CD</b> Chuck Distance      | <input type="checkbox"/> |                            |                          |
| <b>BKL1</b> Band Knurling Length 1          | <input type="checkbox"/>        | <b>SD</b> Shoulder Diameter   | <input type="checkbox"/> |                            |                          |
| <b>BKL2</b> Band Knurling Length 2          | <input type="checkbox"/>        | <b>D1</b> Shoulder Diameter   | <input type="checkbox"/> |                            |                          |
| <b>WL</b> Workpiece Length                  | <input type="checkbox"/>        |                               |                          |                            |                          |

**Figure 5 - ID Internal Knurling**

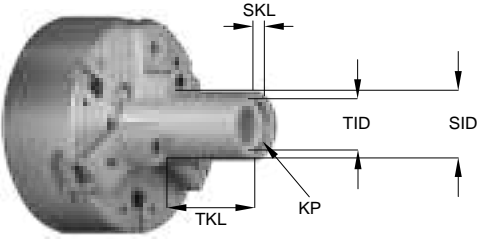

**Knurling Specification**

**Fill Knurling Dimension**

|                                       |                      |                                     |   |
|---------------------------------------|----------------------|-------------------------------------|---|
| <b>TID</b> True Internal Diameter     | <input type="text"/> | <b>SKL</b> Shoulder Knurling Length | <input type="text"/>  |
| <b>SID</b> Shoulder Internal Diameter | <input type="text"/> | <b>KP</b> Knurl Pattern             | <input type="text"/>  |
| <b>TKL</b> True Knurling Length       | <input type="text"/> | <b>PI</b> Knurl Pitch               | <input type="checkbox"/> Inch <input type="checkbox"/> TPI <input type="text"/><br><input type="checkbox"/> DP <input type="text"/><br><input type="checkbox"/> Metric <input type="checkbox"/> P-mm <input type="text"/> |

**Figure 6 - Face Knurling**

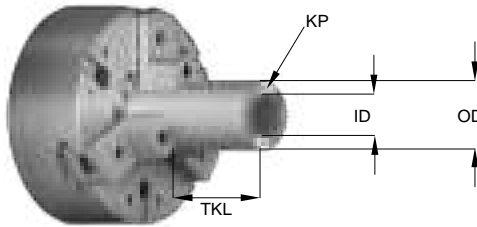

**Knurling Specification**

**Fill Knurling Dimension**

|                            |                      |                         |   |
|----------------------------|----------------------|-------------------------|---|
| <b>ID</b> Inside Diameter  | <input type="text"/> | <b>KP</b> Knurl Pattern | <input type="text"/>  |
| <b>OD</b> Outside Diameter | <input type="text"/> | <b>PI</b> Knurl Pitch   | <input type="checkbox"/> Inch <input type="checkbox"/> TPI <input type="text"/><br><input type="checkbox"/> DP <input type="text"/><br><input type="checkbox"/> Metric <input type="checkbox"/> P-mm <input type="text"/> |

**Figure 7 - Taper Knurling**

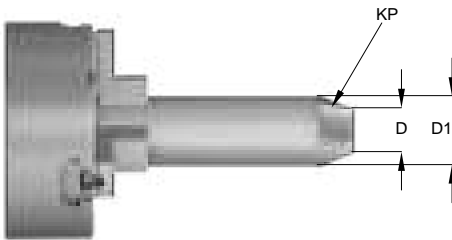

**Knurling Specification**

**Fill Knurling Dimension**

|                          |                      |                         |   |
|--------------------------|----------------------|-------------------------|---|
| <b>D</b> Small Diameter  | <input type="text"/> | <b>KP</b> Knurl Pattern | <input type="text"/>  |
| <b>D1</b> Large Diameter | <input type="text"/> | <b>PI</b> Knurl Pitch   | <input type="checkbox"/> Inch <input type="checkbox"/> TPI <input type="text"/><br><input type="checkbox"/> DP <input type="text"/><br><input type="checkbox"/> Metric <input type="checkbox"/> P-mm <input type="text"/> |

**Figure 8 - Milling Knurling**

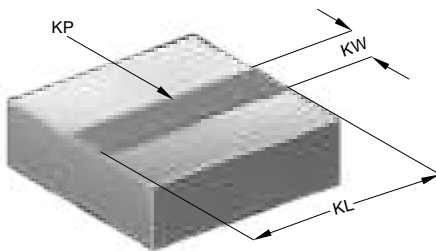













**Knurling Specification**









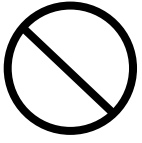

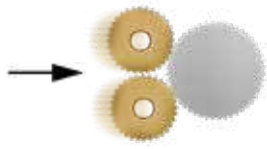

**Fill Knurling Dimension**

|                           |                      |                         |   |
|---------------------------|----------------------|-------------------------|---|
| <b>KW</b> Knurling Width  | <input type="text"/> | <b>KP</b> Knurl Pattern | <input type="text"/>  |
| <b>KL</b> Knurling Length | <input type="text"/> | <b>PI</b> Knurl Pitch   | <input type="checkbox"/> Inch <input type="checkbox"/> TPI <input type="text"/><br><input type="checkbox"/> DP <input type="text"/><br><input type="checkbox"/> Metric <input type="checkbox"/> P-mm <input type="text"/> |

| Knurling Production Information |                                 |                                   |   |
|---------------------------------|---------------------------------|-----------------------------------|---|
| <b>Material</b>                 | <input type="text"/>            | Annealed <input type="checkbox"/> | Heat Treated <input type="checkbox"/>                         |
| <b>Quantity</b>                 | <input type="text"/>            | Hardness <input type="text"/>     |   |
| <b>Machine</b>                  | Manual <input type="checkbox"/> | CNC <input type="checkbox"/>      | Swiss <input type="checkbox"/> Other <input type="checkbox"/> |
| <b>Toolholder Style</b>         | Left <input type="checkbox"/>   | Right <input type="checkbox"/>    | <b>Toolholder Size</b> <input type="text"/>                   |

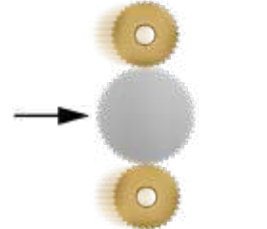
| Knurling Tool Recommendation |                      |                                   |                      |                      |
|------------------------------|----------------------|-----------------------------------|----------------------|----------------------|
| <b>Customer Information</b>  | <b>Figure</b>        | <b>Dorian Tool Recommendation</b> |                      |                      |
| <input type="text"/>         | <input type="text"/> | <b>Item</b>                       | <b>UPC</b>           | <b>Price</b>         |
| <b>Date</b>                  | <input type="text"/> | <input type="text"/>              | <input type="text"/> | <input type="text"/> |
| <b>Company</b>               | <input type="text"/> | Knurling Tool                     |                      |                      |
| <b>Contact</b>               | <input type="text"/> | Knurling Head                     |                      |                      |
| <b>E-mail</b>                | <input type="text"/> | Knurling Wheel                    |                      |                      |
| <b>Telephone</b>             | <input type="text"/> | Knurling Pin                      |                      |                      |









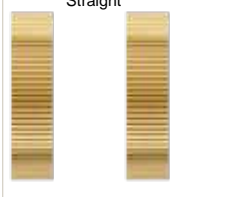

| Knurling Application  | Knurl Wheel Used  |   |   |   |
|---|---|---|---|---|
| <p><b>One Wheel</b><br/> <b>In-feed (Plunge)</b><br/> <b>End-feed</b></p>   | <p>Straight</p>          | <p>Left Hand Diagonal</p>            | <p>Right Hand Diagonal</p>         | <p>Female Diamond</p>                        |
| <p>In-feed (Plunge) with<br/>                     (1) wheel fixed<br/>                     knurling tool holder</p>  | <p>Straight Pattern</p>  | <p>Right Hand Diagonal Pattern</p>  | <p>Left Hand Diagonal Pattern</p>  | <p>Male Diamond Pattern (Raised Points)</p>  |
| <p>End-feed with<br/>                     (1) wheel fixed<br/>                     knurling tool holder</p>          | <p>Straight Pattern</p>  | <p>Right Hand Diagonal Pattern</p>  | <p>Left Hand Diagonal Pattern</p>  |    |



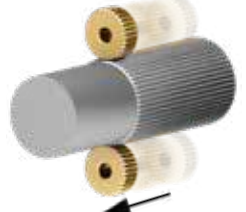



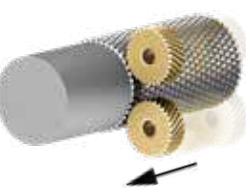

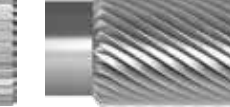
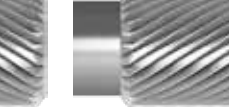
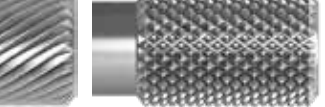
| Knurling Application   | Knurl Wheel Used  |   |   |   |  |  |
|--|---|---|---|---|--|--|
| <p><b>Two Wheels</b><br/> <b>In-feed (Plunge)</b></p>  | <p>Straight</p>          | <p>Left Hand Diagonal</p>            | <p>Right Hand Diagonal</p>         | <p>Male Diamond</p> <p>Right Hand</p>        | <p>Left Hand</p>  |  |
| <p>In-feed (Plunge) with<br/>                     (2) wheels fixed<br/>                     knurling tool holder</p>                                    | <p>Straight Pattern</p>  | <p>Right Hand Diagonal Pattern</p>  | <p>Left Hand Diagonal Pattern</p>  | <p>Male Diamond Pattern (Raised Points)</p>  |  |  |
| <p>In-feed (Plunge) with<br/>                     Adjustable<br/>                     Straddle Style<br/>                     knurling tool holder</p>  | <p>Straight Pattern</p>  | <p>Right Hand Diagonal Pattern</p>  | <p>Left Hand Diagonal Pattern</p>  | <p>Male Diamond Pattern (Raised Points)</p>  |  |  |

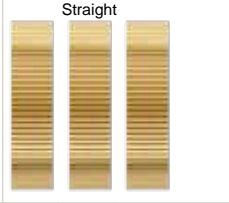
**NOTE:**  
**In-feed (Plunge):** When the knurl wheel is pushed against to the part into radial direction  
**End-feed:** When the Knurl wheel moves longitudinal to the axis of the work piece

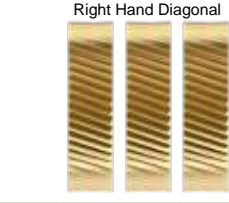
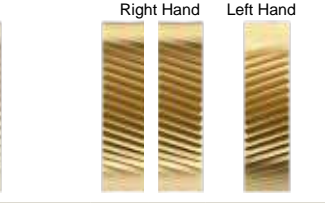
**Knurling Application**

**Knurl Wheel Used**

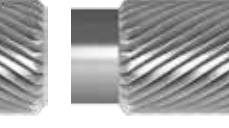
|  |   |   |   |   |
|--|---|---|---|---|
| <p><b>Two Wheels End-feed</b></p>  | <p>Straight</p>          | <p>Left Hand Diagonal</p>           | <p>Right Hand Diagonal</p>         | <p>Male Diamond<br/>Right Hand    Left Hand</p>  |
| <p>End-feed (2) wheels with adjustable straddle knurling tool holder</p>  | <p>Straight Pattern</p>  | <p>Right Hand Diagonal Pattern</p>  | <p>Left Hand Diagonal Pattern</p>  | <p>Male Diamond Pattern (Raised Points)</p>      |
| <p>End-feed (2) wheels with adjustable fixed knurling tool holder</p>     | <p>Straight Pattern</p>  | <p>Right Hand Diagonal Pattern</p>  | <p>Left Hand Diagonal Pattern</p>  | <p>Male Diamond Pattern (Raised Points)</p>      |

|   |   |   |   |  |
|---|---|---|---|--|
| <p><b>Three Wheels End-feed</b></p>   | <p>Straight</p>           | <p>Left Hand Diagonal</p>            | <p>Right Hand Diagonal</p>          | <p>Male Diamond<br/>Right Hand    Left Hand</p>  |
| <p>End-feed (3) wheels with Adjustable Knurl holder cross slide</p>  | <p>Straight Pattern</p>  | <p>Right Hand Diagonal Pattern</p>  | <p>Left Hand Diagonal Pattern</p>  | <p>Male Diamond Pattern (Raised Points)</p>     |

**In-Feed**

Male and Female Diamond knurl wheel pattern  
Can be used only In-Feed

Max. knurl Diamond pattern on the workpiece is equal to the width of the knurl wheel

Male



In-feed

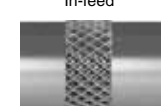

Female



In-feed

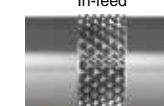

| Tool Depth with Standard Circular Pitch Knurl |                                   | Circular Pitch   |                    |
|---|-----------------------------------|------------------|--------------------|
|   |                                   | inches           | metric             |
| Type of Knurl                                 | Percentage of Depth of Knurl      | 1"<br><u>TPI</u> | Pitch size<br>(mm) |
| Straight Tooth                                | 35% of Circular Pitch (P)         |                  |                    |
| Diagonal                                      | 35% of Normal Circular Pitch (Pn) |                  |                    |
| Diamond                                       | 40% of Normal Circular Pitch (Pn) |                  |                    |
| Diamond Female                                | 25% of Normal Circular Pitch (Pn) |                  |                    |

Table 6 See page H-16

## For Best Knurling Performance

### Before beginning Knurling process check:

- Diameter before knurl
- Diameter after knurl
- Knurl pitch
- Workpiece to be concentric
- Set wheels on center line of workpiece
- Use beveled edge wheels when form knurling
- Use full faced wheels when cut knurling
- Always use coolant when knurling
- The standard knurling depth is 35% of knurl circular pitch.

### Inch Example: Knurling Depth of 20 TPI Knurl

Circular Pitch of 20TPI is:  $1.000/20 = .050"$   
 Knurling Depth is:  $.050" \times .035\% = .0175"$  per side

### Metric Example: Knurling Depth of 2mm Knurl

Knurling Depth is:  $2\text{mm} \times .035\% = .7\text{mm}$  per side

- If the knurl double tracks, the knurl wheel is not deep enough in to workpiece, increase knurling depth
- If the knurl crest rolls over, the knurl wheel is too deep in to the workpiece, decrease knurling depth
- If the knurl is not tracking, the workpiece diameter is not correct for full number of teeth, diameter must adjusted up or down by using a tracking formula.

**In-Feed Knurling**, when the knurl wheel enter into the workpiece radially. Once the knurl wheel has reached the depth, will take from **5 to 20** revolutions to complete the knurling operation. The revolution changes for the same size with the workpiece material hardness and knurl pitch.

**End-Feed Knurling**, when the knurl wheel enter into the workpiece axially. The depth of the knurl wheel must be set before the wheel get in contact with the workpiece, the depth and pressure changes for the same size with the workpiece material hardness and knurl pitch.

## Forming Knurling Versus Cutting Knurl

- In Forming Knurl, the knurl wheel's axis is set parallel to the workpiece axis, and forced against workpiece displacing the material to form the knurl pattern
- A large amount of pressure is required to displace the material that forms the knurl pattern, and pressure increases with workpiece diameter, pitch size and hardness
- In a large workpiece diameter, large knurl pitch, and hard material, a multi knurling pass may be required to achieve the correct knurl pattern
- For best performance and quality in Forming Knurl, when possible, a Straddle Knurling Tool is to be used, the pressure is divided within the knurl wheels over the workpiece, and pressure against the spindle of the machine is totally neutralized.
- Use beveled edge wheel when knurl forming to protect the edge from chipping and for smooth knurling surface.
- Use full face Knurled wheel when knurl cutting, the knurl wheels axis are set on negative angle, the sharp edge will cut the knurl pattern into the workpiece
- In cutting knurl, less pressure is required for the operation, higher speed and feed can be used, (use the same cutting date of High Speed or Cobalt turning tools)
- Use full faced knurl wheel when knurl cutting.

| Use Forming Knurl Tool for:          | Use Cutting Knurl Tool for:                     |
|--------------------------------------|---|
| - Small to medium workpiece diameter | - Medium to large workpiece diameter            |
| - To the shoulder knurling           | - To shoulderless diameter knurling             |
| - To centerless workpiece            | - To hard workpiece materials                   |
| - To band knurling application       | - To long knurling application with live center |
| - When high surface finish required  | - For higher productivity                       |

Knurling is ordinarily performed at the same speeds used as cutting operations. Use the same SFM used for high speed and cobalt tool bits to calculate speeds and feeds. However, where spindle speeds can be reduced without loss of production, it is recommended that spindle speeds be lowered as much as possible to increase knurl life.

## Knurling Pitch Tracking Formula (See page H-12 for formula)

| Step              | Calculation  | Inch   |
|-------------------|--|--------|
| 1                 | TPI  | 10     |
| 2                 | Diameter of the part after knurl                         | 2.130" |
| 3                 | Growth after Knurl based on pitch                        | .038"  |
| 4                 | Diameter of the blank before knurl                       | 2.092" |
| 5                 | Knurl wheel diameter and pattern (Straight)              | .750"  |
| 6                 | Knurl wheel series                                       | R      |
| 7                 | Knurl wheel tracking value                               | 0.033" |
| 8                 | Number of teeth on the workpiece                         | 63.393 |
| <b>Correction</b> |  |        |
| 9                 | Select the full number of teeth on the work piece        | 64     |
| 10                | Knurl wheel tracking value                               | 0.033" |
| 11                | New starting diameter = number of teeth x tracking value | 2.112" |

## Knurling Pitch Tracking Formula

| Step              | Calculation  | Metric   |
|-------------------|--|----------|
| 1                 | Circular pitch   | 2.5 mm   |
| 2                 | Diameter of the part after knurl                         | 50.00 mm |
| 3                 | Growth after knurl based on pitch                        | .97 mm   |
| 4                 | Diameter of the blank before knurl                       | 49.03 mm |
| 5                 | Knurl wheel diameter and pattern (Straight)              | 19.00 mm |
| 6                 | Knurl wheel series                                       | R        |
| 7                 | Knurl wheel tracking value (.033 X 25.4)                 | 0.84 mm  |
| 8                 | Number of teeth on the workpiece                         | 58.49    |
| <b>Correction</b> |  |          |
| 9                 | Select the full number of teeth on the work piece        | 58       |
| 10                | Knurl wheel tracking value                               | 0.8382mm |
| 11                | New starting diameter = number of teeth x tracking value | 48.615mm |

## Applications of knurling

Knurling has a wide variety of applications in day-to-day use. It is most commonly used for decorative purposes and for serrating surfaces where components are locked or keyed together in unit assemblies.

The term "knurling" designates both the process and the knurled portion of the work.

Knurling is obtained by displacement of the material when the knurl is pressed against the surface of a rotating work blank. A knurled tooth is "V" shaped.

Knurling tools are used for producing STRAIGHT, DIAGONAL or MALE and DIAMOND patterns, having teeth of uniform pitch on cylindrical SURFEMALE, TAPER, ROUND and FLAT surface.

## Knurling and Pitch Systems

The CIRCULAR PITCH SYSTEM knurling is related to the distance between the teeth on the circumference of the work blank inch or metric. In inches it usually expressed in terms of the number of teeth per inch (TPI), although sometimes erroneously referred to as Pitch.

The DIAMETRAL PITCH SYSTEM (inch system only) knurling is designed to permit work blank diameters of standard fractional stock sizes ranging from 3/32" - 1".

## In-Feed Knurling (Plunge) (CNC -"X")

Straight or diamond knurling can be produced by using either one or two knurls mounted in a holder in the front or rear of the cross slide which applies direct pressure to the work.

Diamond knurls require greater pressure than straight or diagonal knurls, sometimes placing prohibitive loads on both machine and work, causing damage to the machine.

For a better knurling, Adjustable Floating Straddle Type Holders with two knurls are used. The two opposed knurls form the knurling as they are fed onto the blank. Side pressure on the work and the machine spindle is reduced with the straddle type holders, as most of the pressure required for knurling is absorbed in the holder.

## End-Feed Knurling (To Chuck) (CNC -"Z")

Straight, diagonal, or diamond knurling may be produced with end-feed type knurling holders mounted on the compound or turret.

Knurls used for end-feed knurling should have beveled edges. Only straight and diagonal knurls can be used with the end-feeding holders.

When producing diagonal and diamond knurling, the straight knurls are swiveled in the holder to obtain the diagonal and diamond knurling as the knurls are fed over the blank.

Straight knurling may be produced with end-feeding holders using either straight or diagonal knurls.

End-feeding knurling method permits easier starting of the knurls with uniform raise up of material, resulting in high quality knurling.

## Speed and Feeds

For in-feed knurling, the knurl should be fed toward the work gradually until contact is made with the blank. This can be completed within 5 to 25 work revolutions of the working piece.

For end-feed knurling, the feeds used with the turret vary considerably and are dependent on the pitch of the knurl, the material, the diameter of the work blank, and the hardness being knurled.

## Two Ways to Achieve Knurling

### (1) Forming

Knurl forming is achieved by pushing the knurl wheels against the blank while rotating. This will cause the material to be displaced in cold form, reproducing the same wheel pattern on the blank circumference. The blank is increased accordingly to the Knurl Pitch. The force applied through forming is increased in larger diameters making knurling difficult and slow.



Use beveled edge wheel when knurl forming to protect the edge from chipping and for smooth knurl surface.

### (2) Cutting

Knurl cutting is achieved by using knurl wheels to actually cut instead of forming the blank. The knurl wheels are set at an angle, making the knurling edges of the knurl wheels cut into the blank. Pressure is minimized while speed and feed are increased.



Use full face Knurled wheel when knurl cutting, the knurl wheels axis are set on negative angle, the sharp edge will cut the knurl pattern into the workpiece

## For Best Knurling Results

1. Diameter of part being knurled should be turned to size and concentric to achieve a good knurling quality.
2. Knurl wheels must be exactly in center line with the work piece for an even knurl pattern.
3. Knurl wheels are to run freely and the knurl pin must be secured on the tool holder (the use of a carbide pin is recommended).
4. Use heavy flow of coolant to keep the knurl wheels cool and clean.
5. There are formulas to calculate depth of cut, tracking pitch and cutting parameter. Because of different material hardness, before starting production follow the instructions and with trial error the best result will be achieved.

## When Ordering a Knurling Tool, Specify:

- |                     |                                |
|---------------------|--------------------------------|
| 1. Knurl pattern    | 6. Qty. of parts being knurled |
| 2. Pitch style      | 7. Tool center height          |
| 3. Type of knurl    | 8. Tool shank size             |
| 4. Diameter range   | 9. Right hand or Left hand     |
| 5. Type of material |                                |

Knurling Tools Available:

1. Metric System
2. Inches System

Example: FKT20 = Metric System = 20 mm Shank

FKT75 = Inches System = 3/4 in Shank

## Knurl Patterns

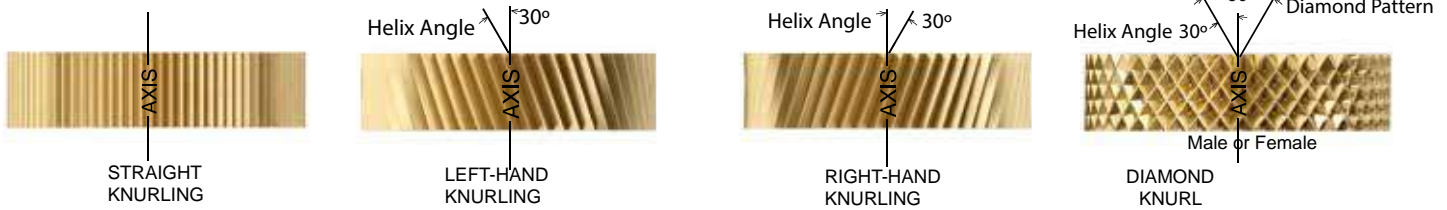

## Tooth Form

A knurled tooth is V-shaped and the depth of the tooth is less than the depth of a theoretical V-form. The tooth has a rounded root and crest. The relationship between the actual depth of tooth to the theoretical V varies with the pitch of the teeth. On finer pitches, the tooth is a smaller proportion of the theoretical V-depth than coarser pitches. Also, female diamond patterns have shallower tooth depth than male diamond patterns.

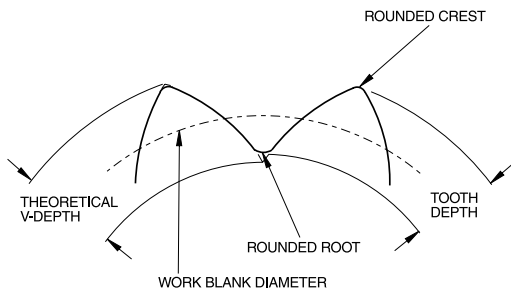

## The Circular Pitch System

Circular pitch knurling is related to the distance between the teeth on the circumference of the work blank. It is usually expressed in terms as the number of teeth per inch, TPI, although sometimes erroneously referred to as pitch.

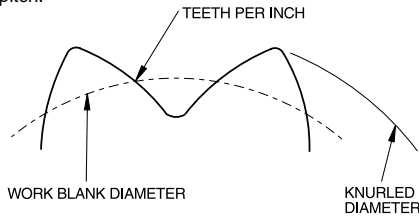

## Number of Teeth per Inch - TPI

TPI refers to the number of teeth per inch measured on the circumference of the work blank diameter. The approximate TPI, however, may be measured on the outside diameter of the knurling for reference purposes. TPI is used and is measured perpendicular to the teeth or helix angle.

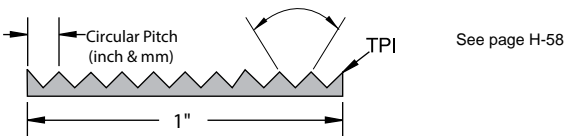

- **TPI system** is the number of teeth per inch (measured on a linear inch).
- **Circular pitch inch system** is the distance from tooth to tooth, or is derived from 1" divided by the number of teeth per inch.
- **Circular pitch metric system** is the distance from tooth to tooth in mm.
- **Diametral pitch system** is derived by the number of teeth on the work divided by the theoretical work blank diameter.

## Straight Knurling

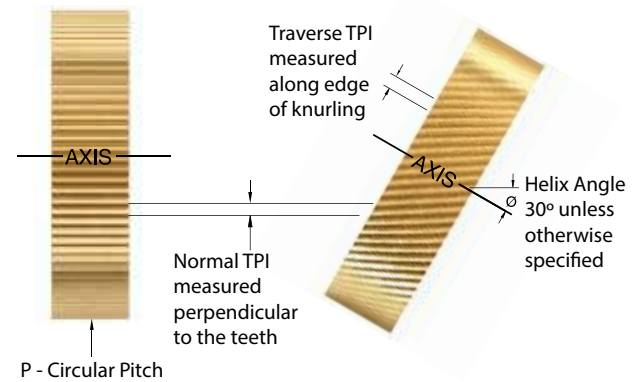

## Diagonal or Diamond Knurling

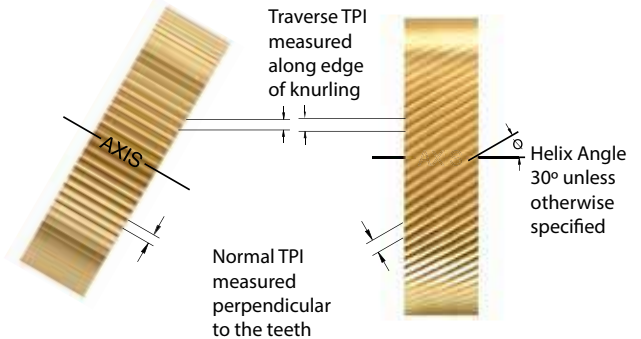

Table 1

Pitch Relation of a Straight Knurl to 30° Transverse

| No. of Teeth per Inch<br>TPI | Straight Knurling<br>Circular Pitch |     | Transverse<br>Circular Pitch |       |     |
|------------------------------|-------------------------------------|-----|------------------------------|-------|-----|
|                              | Inch                                | mm  | TPI                          | Inch  | mm  |
| 8                            | 0.125                               | 3.2 | 6.93                         | 0.144 | 3.7 |
| 10                           | 0.100                               | 2.5 | 8.66                         | 0.115 | 2.9 |
| 12                           | 0.083                               | 2.1 | 10.40                        | 0.096 | 2.4 |
| 14                           | 0.071                               | 1.8 | 12.13                        | 0.082 | 2.1 |
| 16                           | 0.063                               | 1.6 | 13.86                        | 0.072 | 1.8 |
| 18                           | 0.056                               | 1.4 | 15.59                        | 0.064 | 1.6 |
| 20                           | 0.050                               | 1.3 | 17.33                        | 0.058 | 1.5 |
| 25                           | 0.040                               | 1.0 | 21.66                        | 0.046 | 1.2 |
| 30                           | 0.033                               | 0.8 | 25.99                        | 0.038 | 1.0 |
| 35                           | 0.029                               | 0.7 | 30.32                        | 0.033 | 0.8 |
| 40                           | 0.025                               | 0.6 | 34.65                        | 0.029 | 0.7 |
| 50                           | 0.020                               | 0.5 | 43.31                        | 0.023 | 0.6 |
| 80                           | 0.013                               | 0.3 | 69.30                        | 0.014 | 0.4 |

**TPI and Circular Pitch Calculations**

The formula for finding the Transverse Teeth Per Inch (TPI<sub>t</sub>), if the Normal Teeth Per Inch (TPI<sub>n</sub>) is known, is shown below.  
 $TPI_t = TPI_n \times \cos 30^\circ$  (.86603)

The formula for finding the Transverse Circular Pitch (P<sub>t</sub>), if the Circular Pitch (P) is known, is shown below.

$$P_t = \frac{P}{\cos 30^\circ}$$

$$\cos 30^\circ = .86603$$

**TPI and Circular Pitch Examples**

Find the Transverse Pitch if the Normal Pitch is 20 TPI.

$$TPI_t = TPI_n \times \cos 30^\circ = 20 \times .86603 = 17.32 \text{ TPI}_t$$

Find the Transverse Circular Pitch if the Normal Circular Pitch is .0500"

Where .0500" is the Normal Circular Pitch of 20 TPI ( $1 \div .500 = 20$ )

$$P_t = P_n \div \cos 30^\circ = .0500 \div .86603 = .0577 \text{ Circular Transverse Pitch}$$

**Diagonal & Diamond Knurl Tooth & Pitch Calculations**

$$TPI_t = \frac{N_w}{3.1416 \times D_w} \text{ or } TPI_n \times \cos \emptyset \quad TPI_n = \frac{N_w}{3.1416 \times D_w \times \cos \emptyset} \text{ or } \frac{TPI_t}{\cos \emptyset}$$

$$N_w = 3.1416 \times D_w \times TPI_t \text{ or } 3.1416 \times D_w \times TPI_n \times \cos \emptyset$$

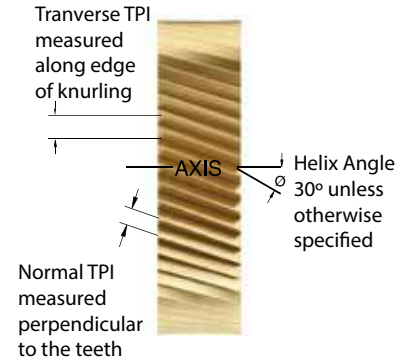

$$N_w = \frac{3.1416 \times D_w}{P_t} \text{ or } \frac{3.1416 \times D_w \times \cos \emptyset}{P_n} \quad D_w = \frac{P_t \times N}{3.1416} \text{ or } \frac{P_n \times N_w}{3.1416 \times \cos \emptyset}$$

**Straight Knurl - Tooth and Pitch Calculations**

$$P = \frac{1.000}{TPI}$$

$$N_w = \frac{3.1416 \times D_w}{P}$$

$$D_w = \frac{P \times N_w}{3.1416}$$

$$TPI = \frac{N_w}{3.1416 \times D_w}$$

Where:

**D<sub>w</sub>** = Theoretical work blank diameter

**N<sub>w</sub>** = Number of teeth on work

**P** = Circular pitch

**TPI** = Number of teeth per inch measured on circumference of blank diameter

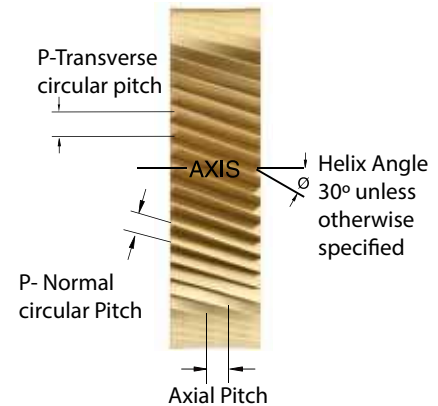
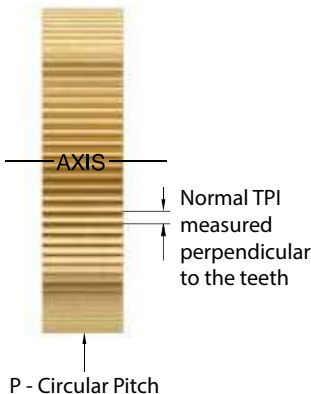

$$P = \frac{1.000}{TPI} \quad P_t = \frac{P_n}{.86603}$$

Where:

**D<sub>w</sub>** = Theoretical work blank diameter

**N<sub>w</sub>** = Number of teeth on work

**P** = Circular pitch

**P<sub>n</sub>** = Normal circular pitch

**P<sub>t</sub>** = Transverse circular pitch

**TPI** = Number of teeth per inch measured on circumference of blank diameter

**TPI<sub>n</sub>** = Normal teeth per inch

**TPI<sub>t</sub>** = Transverse teeth per inch

**∅** = Helix angle

## Standard Diametral Pitches

The four standard diametral pitches available are 64, 96, 128, and 160. The 96 and 160 diametral pitches are for blank diameters having fractional increments of 1/32", and the 64 and 128 diametral pitches are for blank diameters having fractional diameters of 1/64". The American Standard recommends that the use of the 64 diametral pitch should be avoided as much as possible, and for simplification of tools, preference be given to the use of 96 diametral pitch.

The term diametral pitch applies to the quotient of the total number of teeth in the circumference of the work divided by the basic diameter of the work blank. The diametral pitch is the ratio of the number of teeth on the work to the number of inches of basic work blank diameter and equals the number of teeth to each inch of basic blank diameter.

$$P = \frac{N_w}{D_w}$$

Where:

- P=Diametral Pitch
- $N_w$ =Number of teeth on work, or  $P \times D_w$
- $D_w$ =Theoretical work blank diameter or  $\frac{N_w}{P}$

The diametral pitch and the number of teeth are always measured in a transverse plane which is perpendicular to the axis of rotation for diagonal as well as straight knurling.

A comparison of diametral pitches, TPI, and circular pitches is in Table 2.

Diagonal and diamond knurling on work blank may be accomplished by setting the axis of straight knurls at an angle to the work axis.

When using straight knurls to produce diagonal and diamond knurling by end-feeding, the transverse diametral pitch that is produced on the work will not be the same as that of the knurl. The diametral pitch in such instances refers to the diametral pitch on the knurl rather than the knurling produced on the work.

**Table 2**

| Diametral Pitch-Increase of Blank Diameter         |      |                |                                      |      |              |      |  |                      |     |                 |       |       |      |
|--|------|----------------|--------------------------------------|------|--------------|------|--|----------------------|-----|-----------------|-------|-------|------|
| Diametral Pitch Measured in TPI and Circular Pitch |      |                | Approx. Increase in Knurled Diameter |      |              |      | Min. No. of Teeth in Knurled Circumference | Work Blank Diameters |     |                 |       |       |      |
| Diametral Pitch                                    | TPI  | Circular Pitch | Straight                             |      | 30° Diagonal |      |  | Diameter Range       |     | Dia. Increments |       |       |      |
|  |      |                | Inch                                 | mm   | Inch         | mm   |  | Inch                 | mm  |                 |       |       |      |
| 64   | 20.4 | 0.0491         | 0.024                                | 0.61 | 0.021        | 0.53 | 24   | 0.375                | 1.0 | 9.53            | 25.40 | 1/64" | 0.41 |
| 96   | 30.6 | 0.0327         | 0.016                                | 0.41 | 0.014        | 0.36 | 24   | 0.250                | 1.0 | 6.35            | 25.40 | 1/32" | 0.36 |
| 128  | 40.7 | 0.0245         | 0.012                                | 0.30 | 0.010        | 0.25 | 18   | 0.140                | 1.0 | 3.56            | 25.40 | 1/64" | 0.41 |
| 160  | 50.9 | 0.0196         | 0.009                                | 0.23 | 0.008        | 0.20 | 15   | 0.094                | 1.0 | 2.39            | 25.40 | 1/32" | 0.79 |

## Equivalent of Diametral Pitch & TPI Pitch

All Diametral Pitch Knurls made to American Standards (ASA B5.30 1958). Diametral Pitch Knurls produce the D.P. number of teeth per inch of diameter. Rolled Circular Pitch Knurls, produce the TPI number of teeth per inch of circumference measured normal to the teeth.

**Table 3**

| Diametral Pitch | Teeth Per Inch (TPI) |              |
|-----------------|----------------------|--------------|
|                 | Straight             | 30° Diagonal |
| 64              | 20.4                 | 23.6         |
| 96              | 30.6                 | 35.3         |
| 128             | 40.7                 | 47.0         |
| 160             | 50.9                 | 58.8         |

## Work Blank Diameters

Formulae for theoretical work blank diameters are as follows:

$$D_w = \frac{N_w}{P}$$

Where:

- P=Diametral Pitch
- $N_w$ =Number of teeth on work, or  $P \times D_w$
- $D_w$ =Theoretical work blank diameter or  $\frac{N_w}{P}$

For end-feed knurling with straight tooth knurls:

$$D_w = \frac{N_w}{P \times \cos \theta}$$

Where:

- P=Diametral Pitch
- $N_w$ =Number of teeth on work, or  $P \times D_w$
- $D_w$ =Theoretical work blank diameter or  $\frac{N_w}{P}$
- $\theta$ =Angle between knurl axis and work axis (cos 30°=.86603)

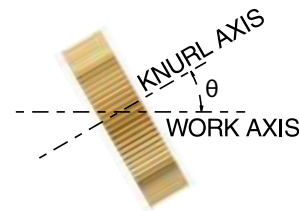

The number of teeth produced on the work blank is measured in the transverse plane and may be determined with the following formula for diagonal knurling.

Where:

- P = Diametral Pitch
- $N_w$  = Number of teeth on work, or  $P \times D_w$
- $D_w$  = Theoretical work blank diameter or  $\frac{N_w}{P}$
- $\theta$  = Angle between knurl axis and work axis

$$N_w = D_w \times P \times \cos \theta$$

## For Example:

If 30° diagonal knurling were to be produced on 1" stock with a 96 diametral pitch straight knurl.

$$N_w = 1.000 \times 96 \times \cos 30^\circ = 83.14 \text{ teeth}$$

(cos30° = 86603)

Increasing the angle between the knurl axis to approximately 30.25° would provide good tracking of the knurl and make it possible to obtain an even 83 teeth instead of 83.14.

By reducing the diameter of the work blank to a decimal size, good tracking of the knurl can be obtained for 30° diagonal knurling according to the following formula:

$$D_w = \frac{N_w}{P \times \cos 30^\circ} = \frac{83}{96 \times .86603} = .998 \text{ inch}$$

The tolerance for work blank diameters vary with the knurling requirements. For general purpose knurling the tolerances generally range between 5 to 8% of the circular pitch and for precise knurling, approximately 2 to 4% of the circular pitch.

Request for Diametral Blank Diameters X 50% larger

### Knurled Diameters (Knurl Forming)

The approximate increase in blank diameters for different teeth per inch with straight, diagonal, and diamond pattern knurling is shown below. The amount of increase shown is based on knurling soft steels and should be used as a guide only. The amount of increase varies slightly with different materials. When the full depth of the knurl is not required (no sharp points), penetrate the work blank to displace at least 75% of the knurl tooth depth. This ensures proper tracking of the knurl on the work. Care should be exercised not to specify knurled diameters with too few teeth. Consideration should be also given to the length of the knurling and the pressure required to force the knurl into the work. The greatest pressures are exerted by the coarser pitches with in-feed knurling using single knurls. Wide knurls require more pressure than narrow knurls. The following tabulation may be used as a guide in selecting the smallest knurled diameters to use for knurling with different number of teeth per inch (TPI) and widths of knurl faces.

Table 4

| Minimum Knurled Diameters<br>For In-feed Rolling with Circular Pitch Knurls on General Applications |                              |       |      |       |      |       |      |
|---|------------------------------|-------|------|-------|------|-------|------|
| Pitch   | Standard Width of Knurl Face |       |      |       |      |       |      |
|   | 3/16"                        |       | 1/4" |       | 3/8" |       |      |
| TPI   | mm                           | Inch  | mm   | Inch  | mm   | Inch  | mm   |
| 16  | 1.6                          | -     | -    | 0.406 | 10.3 | 0.500 | 12.7 |
| 20  | 1.2                          | 0.313 | 7.9  | 0.344 | 8.7  | 0.438 | 11.1 |
| 25  | 1.0                          | 0.250 | 6.4  | 0.281 | 7.1  | 0.375 | 9.5  |
| 30  | 0.8                          | 0.219 | 5.6  | 0.250 | 6.4  | 0.313 | 7.9  |
| 35  | 0.7                          | 0.188 | 4.8  | 0.219 | 5.6  | 0.281 | 7.1  |
| 40  | 0.6                          | 0.156 | 4.0  | 0.188 | 4.8  | 0.250 | 6.4  |
| 50  | 0.5                          | 0.125 | 3.2  | 0.156 | 4.0  | 0.219 | 5.6  |
| 80  | 0.3                          | 0.078 | 2.0  | 0.109 | 2.8  | 0.172 | 4.4  |

Table 5

| Approximate Diameter Increase of Blank<br>with Standard Circular Pitch Knurls |                |                 |                |                 |                 |       |        |        |     |
|---|----------------|-----------------|----------------|-----------------|-----------------|-------|--------|--------|-----|
| Pitch   | Straight       |                 | Diagonal       |                 | Diamond on Part |       |        |        |     |
|   | Circular Pitch |                 | Circular Pitch |                 | Male            |       | Female |        |     |
| TPI   | mm             | Inch            | mm             | Inch            | mm              | Inch  | mm     | Inch   | mm  |
| 8   | 3.2            | 0.042           | 1.1            | 0.042           | 1.1             | 0.046 | 1.2    | -      | -   |
| 10  | 2.5            | 0.038           | 1.0            | 0.038           | 1.0             | 0.042 | 1.1    | -      | -   |
| 12  | 2.1            | 0.034           | 0.9            | 0.034           | 0.9             | 0.038 | 1.0    | 0.023  | 0.6 |
| 16  | 1.6            | 0.025           | 0.6            | 0.025           | 0.6             | 0.029 | 0.7    | 0.017  | 0.4 |
| 20  | 1.2            | 0.020           | 0.5            | 0.020           | 0.5             | 0.023 | 0.6    | 0.014  | 0.4 |
| 25  | 1.0            | 0.016           | 0.4            | 0.016           | 0.4             | 0.018 | 0.5    | 0.011  | 0.3 |
| 30  | 0.8            | 0.013           | 0.3            | 0.013           | 0.3             | 0.015 | 0.4    | 0.009  | 0.2 |
| 35  | 0.7            | 0.011           | 0.3            | 0.011           | 0.3             | 0.013 | 0.3    | 0.007  | 0.2 |
| 40  | 0.6            | 0.009           | 0.2            | 0.009           | 0.2             | 0.010 | 0.3    | 0.006  | 0.2 |
| 50  | 0.5            | 0.009           | 0.2            | 0.009           | 0.2             | 0.010 | 0.3    | 0.006  | 0.2 |
| 80  | 0.3            | 0.005           | 0.1            | 0.005           | 0.1             | 0.006 | 0.2    | 0.004  | 0.1 |
| TPI   | mm             | Diametral Pitch |                | Diametral Pitch |                 | Male  |        | Female |     |
| TPI   | mm             | Inch            | mm             | Inch            | mm              | Inch  | mm     | Inch   | mm  |
| 64  | 0.4            | 0.024           | 0.6            | 0.021           | 0.5             | 0.024 | 0.6    | 0.015  | 0.4 |
| 96  | 0.3            | 0.016           | 0.4            | 0.014           | 0.4             | 0.016 | 0.4    | 0.010  | 0.3 |
| 128   | 0.2            | 0.012           | 0.3            | 0.010           | 0.3             | 0.012 | 0.3    | 0.007  | 0.2 |
| 160   | 0.1            | 0.009           | 0.2            | 0.008           | 0.2             | 0.009 | 0.2    | 0.005  | 0.1 |

### Tooth Depth

Depth of tooth is in direct relationship with circular pitch knurl with approximate percentages which will vary, accordingly to material, speed, and feed used in knurling.

Table 6

| Tool Depth with Standard Circular Pitch Knurl | Circular Pitch                    |                    |
|---|-----------------------------------|--------------------|
|   | inches                            | metric             |
| Type of Knurl                                 | Percentage of Depth of Knurl      |                    |
| Straight Tooth                                | 35% of Circular Pitch (P)         |                    |
| Diagonal                                      | 35% of Normal Circular Pitch (Pn) |                    |
| Diamond                                       | 40% of Normal Circular Pitch (Pn) |                    |
| Diamond Female                                | 25% of Normal Circular Pitch (Pn) |                    |
|   | 1"<br>TPI                         | Pitch size<br>(mm) |

### Tooth Depth Examples

Inch Circular Pitch: find the circular pitch and depth of tooth for a straight tooth knurl and has 20 TPI.

$$P = \frac{1"}{20 \text{ TPI}} = .0500 \text{ Circular Pitch}$$

Metric Circular Pitch: The distance from tooth to tooth

$$P = 1 \text{mm Circular Pitch} \quad \text{Tool Depth} = 1 \times 35\% = .35$$

The resulting depth is per side. Multiply x2 for depth on diameter.

### Tracking Calculations for Forming and Cutting knurl.

Follow the steps 1-10 below to prepare the proper diameter to turn your diameter before knurling in order to improve the success of knurling without double tracking.

**Step 1:** Diameter of the part after knurl: \_\_\_\_\_  
(skip to step 3 if the diameter before knurl is only diameter specified)

**Step 2:** Growth of material after knurling based on TPI: \_\_\_\_\_  
(see Table 5)

**Step 3:** Diameter before knurl \_\_\_\_\_  
(step 1 - step 2, or use diameter given on print if starting here at this step)

**Step 4:** Quick calculator value: \_\_\_\_\_  
(see knurl wheel pages for your exact wheel. Example: shown below .0330)  
PAGES H-60 to H-70

**Step 5:** Calculate number of teeth on part after knurl: \_\_\_\_\_  
(diameter of part before knurl from step 3 / quick calculator value, example: 1.138 dia / .033 = 34.5 teeth on part after knurl)

**Step 6:** Evaluate value in step 5  
(fractional values can lead to double tracking. In the above example, there will be 34 teeth on the part with .5 of a tooth left over. This 1/2 tooth overtravel will most likely double track. To solve this continue to step 7)

**Step 7:** Round to closest whole number \_\_\_\_\_  
(in the above example either 34 or 35 can be used)

**Step 8:** Calculate new diameter to turn material before knurl: \_\_\_\_\_  
(quick calculator value x rounded number of teeth from step 7, example: .033 x 34 = 1.122 diameter of the part before knurl to track properly)

**Step 9:** Calculate diameter after knurl based on new tracking diameter: \_\_\_\_\_  
(add growth value from step 2 to new tracking diameter from step 8)

**Step 10:** Verify against print tolerances

### Example for Step 4:

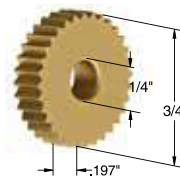

| Circular Knurl Pitch |        | Included Tooth Angle | Knurl Pattern | R Series      | Straight          |
|----------------------|--------|----------------------|---------------|---------------|-------------------|
| Inch                 | Metric |                      |               | Knurl Wheel   | Cobalt TiN Coated |
| 10 (TPI)             | 2,5mm  | 90°                  | Coarse        | Description   | RS-10-C           |
|                      |        |                      |               | Tracking Data | 23T / .0330"      |
|                      |        |                      |               | Standard      | 26502             |

### Traditional Formula for Step 5:

Table 7

| Correction Factor |                       |      |
|-------------------|-----------------------|------|
| TPI               | Approx. Value of C.F. |      |
|                   | Inch                  | mm   |
| 12-19             | 0.010                 | 0.3  |
| 20-29             | 0.007                 | 0.2  |
| 30-39             | 0.005                 | 0.1  |
| 40-49             | 0.003                 | 0.1  |
| 50-80             | 0.002                 | 0.05 |

\*\* This value is affected somewhat by machine speeds, material hardness, relative diameters of knurl and blank.

$$\text{Teeth (on blank)} = \frac{\text{Teeth (on knurl tool)} \times \text{Diameter (Blank)}}{\text{Diameter (wheel)} + \text{Correction Factor}}$$

\* Note: These formulas apply accurately only to knurls In-Fed from the cross-slide.

## Cutting Speed

**Knurling** is ordinarily performed at the same speeds used as turning operations. To calculate the cutting parameter of a knurling operation, use the same SFM used for high speed and cobalt tool bits to calculate (RPM) revolution of the workpiece and Knurling ( $f_n$ ) feed rate.

**For in-feed knurling**, the knurl should be fed toward the work gradually until contact is made with the blank. As few work revolutions as possible should be allowed for feeding the knurl into the work. The knurl should be fed to full depth as rapidly as permissible without causing undue pressure on the work, the tools, and the equipment. Too many revolutions may result in a roughened or slivered tooth surface and destruction of the knurl and the knurling tool (5 to 20 REV)

**For end-feed knurling**, the rate of feed is governed by the type of material being knurled, diameter and rigidity of the work, and the width and pitch of the knurl. Faster feeds are used for the softer materials and slower feeds for harder materials.

### Knurling Formula:

$$RPM = \frac{12 \times SFM}{\pi \times DIA} \quad SFM = \frac{(DIA \times \pi) \times RPM}{12}$$

Although the knurling should be normally completed within 10 to 25 work revolutions, the ability of many machine cross slides to operate at the desired high speeds prohibits the use of the preferred revolutions, especially when high work spindle speeds are used.

The cam rise must be continuous with no dwell or backing away until the high point is reached. It is desirable to have a slight dwell on the cam at the completion of the feeding which allows several revolutions of the work with the knurl at full tooth depth. The amount of dwell depends upon the nature of the work and the material. The knurl should be then withdrawn from the work quickly.

The feeds used for end-feed knurling with the turret vary considerably and are dependent upon the pitch of the knurl, material being knurled, and the nature and diameter of the work.

**-Warning-** Speeds and feeds information in the catalog are for reference only. If the operator does not feel safe using our speeds and feed recommendation, the operator should use what he or she is comfortable with. Dorian Tool is not responsible for any injuries that may occur.

## Knurling SFM and $V_c$ parameter

Table 8

| Material and Knurl Pitch     |                        |       |              | Knurl Forming                     |  |                     |                | Knurl Cutting                 |  |          |  |
|------------------------------|------------------------|-------|--------------|-----------------------------------|--|---------------------|----------------|-------------------------------|--|----------|--|
|                              |                        |       |              |                                   |  |                     |                |                               |  |          |  |
| Material Description         | Material Specs         | TPI   | Metric Pitch | Forming Speed (SFM and $V_c$ )    |  | Feed rate ( $f_n$ ) |                | Cutting Speed                 |  | End Feed |  |
|                              |                        |       |              | Smaller <Wheel dia. > Larger      |  | End Feed            | In Feed        | Smaller <Wheel dia. > Larger  |  |          |  |
| Low carbon steel             | 1018<br>1117<br>1215   | >14   | >1,8         | 50-210 SFM<br>[15-63 $V_c$ m/min] |  | 0.006"              | .001-.003"     | 100-350 SFM<br>[30-106 m/min] |  | 0.009"   |  |
|                              |                        |       |              |                                   |  | [0,15mm]            | [,025-.075mm]  |                               |  | [,23mm]  |  |
|                              |                        | 16-20 | 1,6-1,2      |                                   |  | 0.008"              | .002-.004"     |                               |  | 0.011"   |  |
|                              |                        |       |              |                                   |  | [0,20mm]            | [0,050-.100mm] |                               |  | [,28mm]  |  |
|                              |                        | 25-35 | 1,0-0,7      |                                   |  | 0.010"              | .002-.004"     |                               |  | 0.013"   |  |
|                              |                        |       |              |                                   |  | [,25mm]             | [,050-.100mm]  |                               |  | [,33mm]  |  |
|                              |                        | 40>   | 0,6>         |                                   |  | 0.012"              | .002-.004"     |                               |  | 0.015"   |  |
|                              |                        |       |              |                                   |  | [,30mm]             | [,050-.100mm]  |                               |  | [,38mm]  |  |
| Alloy Steel<br>Tool steels   | 4130<br>4140<br>D2     | >14   | >1,8         | 35-150 SFM<br>[10-45 m/min]       |  | 0.004"              | .001-.002"     | 70-250 SFM<br>[21-75 m/min]   |  | 0.007"   |  |
|                              |                        |       |              |                                   |  | [,10mm]             | [,025-.050mm]  |                               |  | [,18mm]  |  |
|                              |                        | 16-20 | 1,6-1,2      |                                   |  | 0.005"              | .001-.003"     |                               |  | 0.008"   |  |
|                              |                        |       |              |                                   |  | [,13mm]             | [,025-.075mm]  |                               |  | [,20mm]  |  |
|                              |                        | 25-35 | 1,0-0,7      |                                   |  | 0.007"              | .001-.003"     |                               |  | 0.010"   |  |
|                              |                        |       |              |                                   |  | [,18mm]             | [,025-.075mm]  |                               |  | [,25mm]  |  |
|                              |                        | 40>   | 0,6>         |                                   |  | 0.009"              | .001-.003"     |                               |  | 0.012"   |  |
|                              |                        |       |              |                                   |  | [,23mm]             | [,025-.075mm]  |                               |  | [,30mm]  |  |
| Stainless Steel              | 304<br>17-4            | >14   | >1,8         | 35-150 SFM<br>[10-45 m/min]       |  | 0.004"              | .001-.002"     | 70-250 SFM<br>[21-75 m/min]   |  | 0.007"   |  |
|                              |                        |       |              |                                   |  | [,10mm]             | [,025-.050mm]  |                               |  | [,18mm]  |  |
|                              |                        | 16-20 | 1,6-1,2      |                                   |  | 0.005"              | .001-.003"     |                               |  | 0.008"   |  |
|                              |                        |       |              |                                   |  | [,13mm]             | [,025-.075mm]  |                               |  | [,20mm]  |  |
|                              |                        | 25-35 | 1,0-0,7      |                                   |  | 0.007"              | .001-.003"     |                               |  | 0.010"   |  |
|                              |                        |       |              |                                   |  | [,18mm]             | [,025-.075mm]  |                               |  | [,25mm]  |  |
|                              |                        | 40>   | 0,6>         |                                   |  | 0.009"              | .001-.003"     |                               |  | 0.012"   |  |
|                              |                        |       |              |                                   |  | [,23mm]             | [,025-.075mm]  |                               |  | [,30mm]  |  |
| Aluminum<br>Brass<br>Plastic | 6061<br>C360<br>Delrin | >14   | >1,8         | 90-390 SFM<br>[27-118 m/min]      |  | 0.008"              | .002-.004"     | 110-420 SFM<br>[33-127 m/min] |  | 0.011"   |  |
|                              |                        |       |              |                                   |  | [,20mm]             | [,050-.100mm]  |                               |  | [,28mm]  |  |
|                              |                        | 16-20 | 1,6-1,2      |                                   |  | 0.010"              | .003-.005"     |                               |  | 0.013"   |  |
|                              |                        |       |              |                                   |  | [,25mm]             | [,075-.125mm]  |                               |  | [,33mm]  |  |
|                              |                        | 25-35 | 1,0-0,7      |                                   |  | 0.013"              | .003-.005"     |                               |  | 0.016"   |  |
|                              |                        |       |              |                                   |  | [,33mm]             | [,075-.125mm]  |                               |  | [,40mm]  |  |
|                              |                        | 40>   | 0,6>         |                                   |  | 0.017"              | .003-.005"     |                               |  | 0.020"   |  |
|                              |                        |       |              |                                   |  | [,43mm]             | [,075-.125mm]  |                               |  | [,50mm]  |  |

Note: When knurling, start with low Cutting speed, to evaluate the wheel performance, (to avoid the premature life of the wheel) increase until optimum cutting speed and feed is achieved

### Dimensioning of Diametral and Circular Pitch Knurling

Uniform drafting practice is desirable and dimensioning should include length and knurled diameter of the knurling and specifications of the teeth. The method for dimensioning diameters and tooth specifications is important as improper use of dimensions may result in considerable confusion.

Always specify the **tooth pattern** of the knurling, stating whether it is **straight, diagonal, or diamond** (male or female) **pattern**. Note whether the diagonal knurling is **right** or **left** hand, and indicate the **helix angle**.

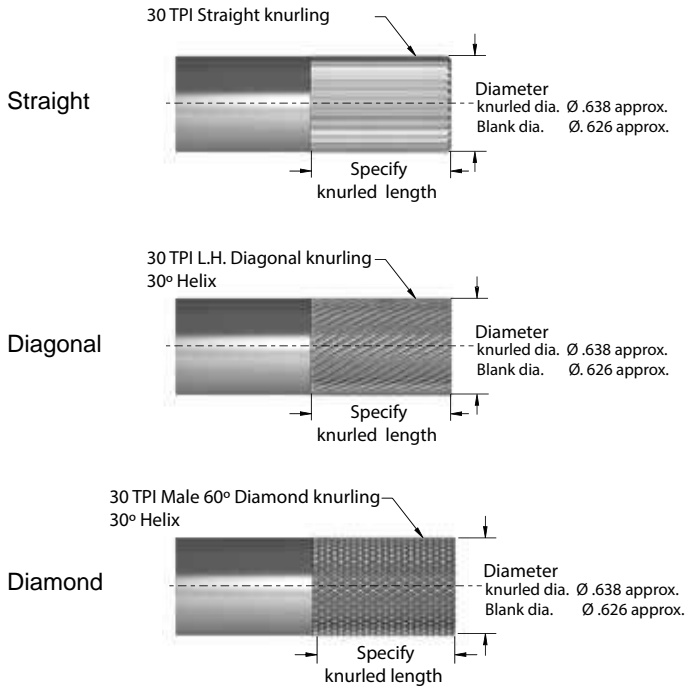

### General Purpose Knurling

For general purpose knurling, only limited dimensions are necessary.

- TPI (Teeth Per Inch) or Coarse / Medium / Fine
- Work Blank Diameter
- Knurled Diameter

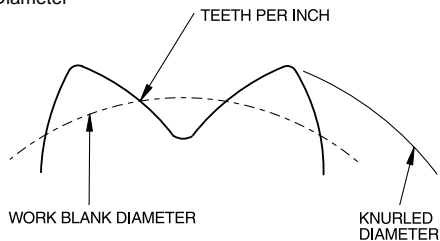

### Precision Knurling

Knurled diameters and the circular pitch of the knurl are related. The circumference of the work blank should be an approximate multiple of the circular pitch for straight knurling and transverse circular pitch for diagonal and diamond knurling. Blank diameters vary with the circular pitch of the knurling selected, and should only be specified after the proper diameter of blank is determined by trial and error.

### Knurling head center line adjustment



- Knurl tool is too low from center line.
- Top wheel is cutting a deeper R.H. Diagonal Knurl.
- Adjust center height until both wheels are on center and touching simultaneously.



- Knurl tool is too high from center line.
- Bottom wheel is cutting a deeper L.H. Diagonal Knurl.
- Adjust center height until both wheels are on center and touching simultaneously.



- Tool is on center line.
- Both wheels are touching simultaneously, forming a perfect diamond knurl.

Note: For a symmetric and even knurl pattern on the workpiece, the knurl wheels must be set on centerline of the workpiece. Both wheels must touch simultaneously

# Common Knurling Problems

| Common Knurling Problems            |  |  |
|-------------------------------------|--|--|
| Problem                             | Cause  | Solution   |
| <b>Knurling double tracking</b>     | <ol style="list-style-type: none"> <li>1) Knurl wheel not deep enough into the workpiece</li> <li>2) The circumference of the workpiece blank is a not full multiple of the knurl pitch</li> </ol>   | <ol style="list-style-type: none"> <li>1) Increase the depth of the knurl wheel into the workpiece</li> <li>2) Change the blank diameter +/- .005" (.127mm) or use the tracking formula</li> </ol>   |
| <b>Knurling flaking or slivered</b> | <ol style="list-style-type: none"> <li>1) Knurling a workpiece material with scaling or rough surface</li> <li>2) Over-rolling the knurl wheel into the workpiece when in-feed knurling</li> <li>3) Knurl Wheel too deep into the workpiece when end-feeding</li> <li>4) Using 1:1 knurl to workpiece ratio</li> </ol>   | <ol style="list-style-type: none"> <li>1) Turn the scaling or the rough surface of workpiece into a smooth surface</li> <li>2) When in-feed knurling, reduce the depth of the knurl wheel, or reduce the number of revolutions after the knurl wheel has reached knurling depth</li> <li>3) When end-feeding, reduce the depth of the knurl wheel</li> <li>4) Use larger or smaller diameter wheel</li> </ol>  |
| <b>Knurl destruction</b>            | <ol style="list-style-type: none"> <li>1) Knurling a workpiece material with scaling or rough surface</li> <li>2) Over-rolling the knurl wheel into the workpiece when in-feed knurling</li> <li>3) Knurl Wheel too deep into the workpiece</li> <li>4) Use of sharp full faced knurl wheel when knurl forming</li> </ol>  | <ol style="list-style-type: none"> <li>1) Reduce the depth of the knurl wheel</li> <li>2) Reduce the number of revolutions after the knurl wheel has reached knurling depth</li> <li>3) Reduce feed and speed and improve coolant flow</li> <li>4) Use beveled edge when form knurling</li> </ol>  |
| <b>Knurl wheel poor life</b>        | <ol style="list-style-type: none"> <li>1) Knurling a workpiece material with scaling or rough surface</li> <li>2) Over-rolling the knurl wheel into the workpiece when in-feed knurling</li> <li>3) Knurl Wheel too deep into the workpiece when end-feeding</li> <li>4) Workpiece material too hard, or difficult to knurl (stainless steels and high temp alloys)</li> <li>5) Workpiece not running concentric</li> <li>6) Workpiece too hard</li> <li>7) Knurl wheel not properly hardened</li> <li>8) Poor lubrication</li> <li>9) Not using the correct knurl wheel for the application</li> <li>10) Knurl wheel not beveled</li> </ol> | <ol style="list-style-type: none"> <li>1) Turn the scaling or the rough surface of workpiece into a smooth surface</li> <li>2) When in-feed knurling, reduce the depth of the knurl wheel, or reduce the number of revolutions after the knurl wheel has reached knurling depth</li> <li>3) When end-feeding, reduce the depth of the knurl wheel</li> <li>4) Reduce feed and speed and improve coolant flow</li> <li>5) Turn workpiece concentric and into a smooth surface</li> <li>6) Reduce workpiece speed</li> <li>7) Change the knurl wheel</li> <li>8) Improve coolant flow</li> <li>9) Use beveled knurl wheel(s) when forming knurling; use full faced knurl wheel(s) for cutting knurling</li> <li>10) Use a beveled knurl wheel</li> </ol> |
| <b>Uneven depth of knurl</b>        | <ol style="list-style-type: none"> <li>1) Knurling a workpiece material with scaling or rough surface</li> <li>2) Workpiece not running concentric</li> <li>3) Using 1:1 knurl to workpiece ratio</li> </ol>   | <ol style="list-style-type: none"> <li>1) Turn the scaling or the rough surface of workpiece into a smooth surface</li> <li>2) Turn workpiece concentric and into a smooth surface</li> <li>3) Use larger or smaller diameter wheel</li> </ol>   |
| <b>Twisted knurl pattern</b>        | <ol style="list-style-type: none"> <li>1) Knurl wheel not deep enough into the workpiece</li> <li>2) The circumference of the workpiece blank is not a full multiple of the knurl pitch</li> </ol>   | <ol style="list-style-type: none"> <li>1) Increase the depth of the knurl wheel</li> <li>2) Change the blank diameter +/- .005" (.127mm) or use the tracking formula</li> </ol>  |
| <b>Uneven Knurl Pattern</b>         | <ol style="list-style-type: none"> <li>1) Knurl wheels are not in centerline of the workpiece</li> </ol>   | <ol style="list-style-type: none"> <li>1) For a symmetric and even knurl pattern on the workpiece, the knurl wheels must to be set on centerline properly</li> </ol>   |

## Wheel and Pin Care For Shoulder Type Form Tools



To replace or check knurl wheel and pin check the following:

### 1. Removal of Knurl Pin

After all the holding screws are removed, sometimes the pin is still tight in the holder. These can be removed by slightly tapping them out with a proper punch.

### 2. Inspection

Inspect the wheel and pin for burrs or other characteristics which may inhibit proper function of the wheel and pin.

### 3. Lubrication

Use plenty of high temperature grease between knurl and pin.

### 4. Wheel and Pin Engagement

The pin should be tightened until the knurl wheel is free of play yet can spin freely by hand.

## Wheel and Pin Care For Shoulderless Type Form Tools



To replace or check knurl wheel and pin check the following:

### 1. Removal of Knurl Pin

After all the holding screws are removed, sometimes the pin is still tight in the holder. These can be removed by slightly tapping them out with a proper punch.

### 2. Inspection

Inspect the wheel and pin for burrs or other characteristics which may inhibit proper function of the wheel and pin.

### 3. Lubrication

Use plenty of high temperature grease between knurl and pin.

### 4. Wheel and Pin Engagement

Tighten the holding screws to hold the pin secure with the wheel placed inside the holder.

## For single wheel knurling tool

### 1. Mounting instructions:

Clamp the shank at right angles to the axial center line of the machine.



**2. Center Height:** Center height is not as critical on a single wheel tool as the wheel contact at all positions. Although too much difference may make it harder to judge depth engagement when feeding into the part.

**3. Knurling setup:** With the spindle rotating slowly, in-feed (Plunge) the tool slowly until the wheel starts to move. Set this position as your zero point.

**4. Starting the knurl:** Start the machine and position the knurl. If the knurl is starting on the end of the part, position the wheel 1/8" on the end. Then, in-feed (Plunge) to the full depth calculated using the formulas on the previous pages.

If knurling a straight pattern the tool can then be fed longitudinally (end feed) with automatic feed. If knurling a diamond pattern, this type of tool is plunge only (in feed); longitudinal (end feed) is not recommended. See page H-16 for approximate feed rates.

**Important:** Always use a steady flow of coolant to keep the wheel cool and free of chips.

## For double wheel fixed knurli

### 1. Mounting instructions:

Clamp the shank at right angles to the axial center line of the machine.



**2. Center Height:** Center height is critical on a double wheel tool as the eye can see even the smallest variance when producing a cosmetic knurl. This style of tool is recommended for machines that have a means to adjust center height. It may be used on a CNC, but will be cumbersome during setup to shim to center.

**3. Knurling setup:** With the spindle rotating slowly, in-feed (Plunge) the tool slowly until both wheels starts to move at the same time. Set this position as your zero point.

**4. Starting the knurl:** Start the machine and position the knurl. If the knurl is starting on the end of the part, position the wheel 1/8" on the end. Then, in-feed (Plunge) to the full depth calculated using the formulas on the previous pages. The tool can then be fed longitudinally (end-feed) with automatic feed. See page H-16 for approximate feed rates.

**Important.** Always use a steady flow of coolant to keep the wheels cool and free of chips.

## Beveled versus Full Faced

When knurling longitudinally (end-feed) beveled edge knurl wheels should be used during form knurling, allowing the knurling wheel to gradually form the knurled part without chipping the edge of the wheel, and create a cleaner and smoother knurled pattern.



When plunge knurling (In Feed) a beveled or full faced knurl wheel may be used according to the required width.

Use full faces wheels for cutting knurling applications.

## Edge Prep

## For double wheel self-centering knurling tool

### 1. Mounting instructions:

Clamp the shank at right angles to the axial center line of the machine.



**2. Center Height:** Center height is critical on a double wheel tool as the eye can see even the smallest variance when producing a cosmetic knurl. This style of tool is recommended for most machines because of its easy set up. There is no need to adjust center height.

**3. Knurling setup:** With the spindle rotating slowly, in-feed (Plunge) the tool slowly until the top wheel touches. The top wheel will always touch because of gravity. Continue feeding until the head pivots and the bottom wheel starts to move. Set this position as your zero point.

**4. Starting the knurl:** Start the machine and position the knurl. If the knurl is starting on the end of the part, position the wheel 1/8" on the end. Then, in-feed (Plunge) to the full depth calculated using the formulas on the previous pages. The tool can then be fed longitudinally (end-feed) with automatic feed. See the Speed and Feed for approximate feed rates.

**Important:** Always use a steady flow of coolant to keep the wheel cool and free of chips.

## For Straddle Style Knurl Tools

**1. Mounting instructions:** Clamp the shank at right angle to the axial center line of the machine.



**2. Center Height:** Dorian straddle style tools have some floatation to allow centering during setup.

**3. Knurling setup:** Dorian straddle knurling tools are adjusted using one screw that moves both arms. The screw is slightly shorter than the body to allow some floating. Knurling is performed with the set screws locked to hold the arms rigid.

### The tool is adjusted and set up as follows:

- Loosen locking screws on the side of the holder.
- Use a hex wrench to turn screw to open the arms larger than the part.
- Calculate the diameter required for the depth of the knurls using the formulas provided earlier in the text.
- Place a piece of raw material into the chuck and turn it to the diameter determined above.
- Jog the tool to place the wheels above and below the part on centerline.
- Turn the adjustment screw until both wheels touch the material.
- Lock the locking screws over the arms only. Tightening the other screws will bend the protective shim.
- The tool is now set on center and at depth to knurl the actual part.

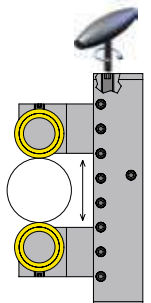

**4. Starting the knurl:** Start the machine and position the knurl. If the knurl is starting on the end of the part, position the wheel 1/8" on the end. Then, in-feed (Plunge) to the centerline of the part. The tool can then be fed longitudinally (end-feed) with automatic feed. See page H-16 for approximate feed rates.

**Important:** Always use a steady flow of coolant to keep the wheel cool and free of chips.

**Knurling on conical, concave, convex, or radial surface**

Often, parts require knurling on conical, concave, convex, or radial surfaces, either for functional or decorative purposes. With proper tools and application, a clean, well-formed knurl or serrations can be produced.

One of the most frequent mistakes made is illustrated in **Figure 1**. In this case, usually for convenience, the knurling tool and the part are set with parallel axis. This is similar to running a pair of bevel gears the wrong way. As the cone angle increases, the results become worse.

**Figure 2** while technically not correct, is better than **Figure 1**, and has the advantage of being a substantially lower cost tool. This method is satisfactory on relatively large diameters when the cone angle is small.

**Figure 3** illustrates the proper method of rolling conical surfaces to produce a clean knurl with maximum tool life. With proper designed tools, and using this method, it is possible to roll tapered serrations with a controlled number of teeth.

For proper tracking at both ends of the piece, it is necessary to establish the geometrical relationship between the part and the tool with consideration given to the space available for tooling. It is sometimes advantageous to use a shank-type knurl, as shown in **Figure 4** where clearance is not available for the conventional style knurl holder.

In certain cases, parts may be knurled with radial teeth on the end of parts, by using a conical knurl of the proper design. Here again, the results depend primarily on establishing the geometrical relationship between the part and the tool (**See Figure 5**).

A tracking correction factor is usually applied to the calculated diameter because of the many variables involved, such as hardness of material, elasticity of machine tools and tool holders, etc. This factor is necessarily empirical.

It is geometrically impossible to knurl a perfect concave or convex part with conventional knurls. The problem is illustrated in **Figure 6**. If the pitch on the tool or part changes by more than 25% from the middle to the edges, poor results can be expected on the finished part. A change of less than 10% in the pitch should produce a clean looking part.

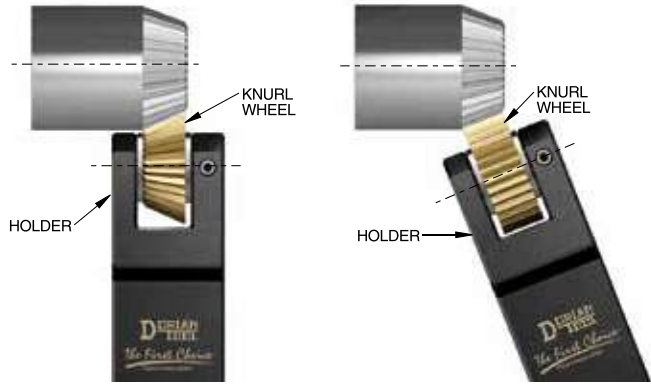

**Figure 1 - Not good**

**Figure 2 - Better**

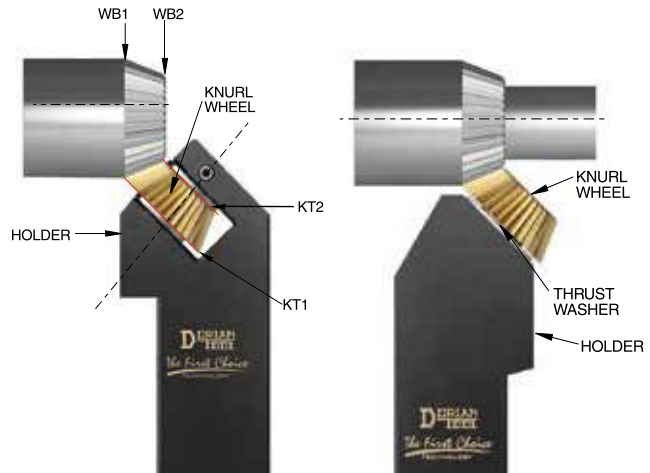

**Figure 3 - Best**

**Figure 4 - Shank-Type Knurl**

SEE FIGURE 3

$$\frac{WB1}{*KT1} = \frac{WB2}{*KT2}$$

\* Correction Factor Less Tracking

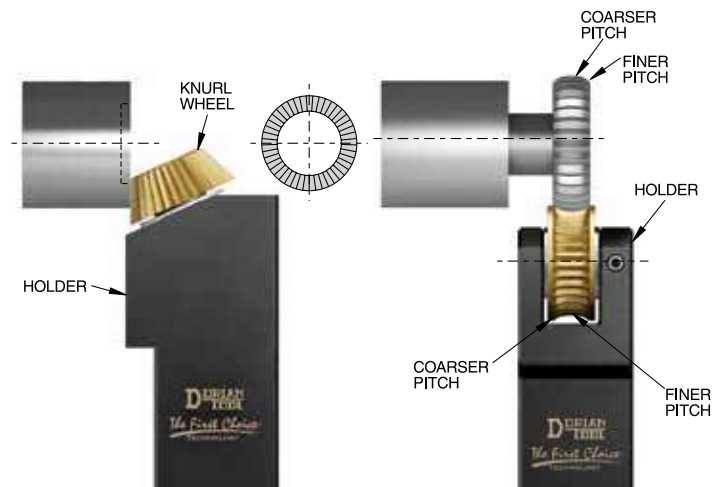
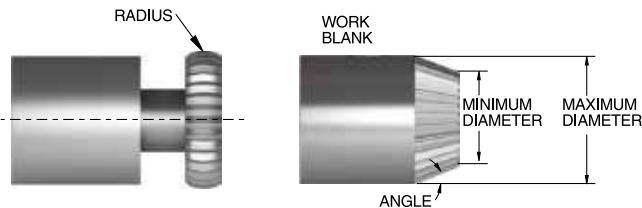

**Figure 5 - End Knurling**

**Figure 6 - Convex Knurling**

## E = Shoulder Clearance

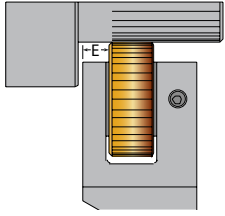

The minimal distance to a shoulder that the knurl tool can approach.

## T = Shank Width

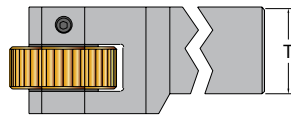

The width of the shank. This can be square or rectangular.

## T1 = Head width

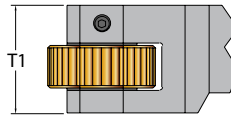

The width of the head can help to determine placement of the tool on the part.

## S = Shank Height

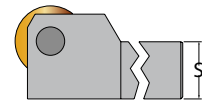

The height of the shank. This is determined by the requirement of the lathe

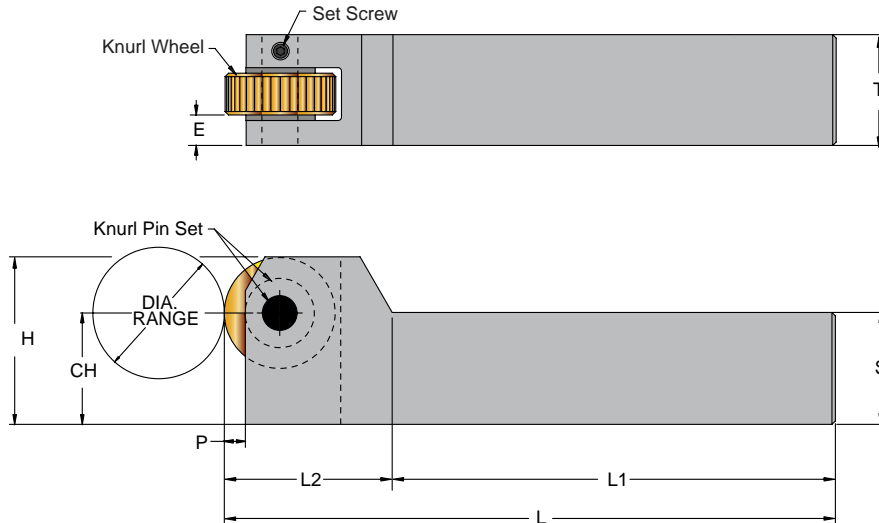

## H = Head Height

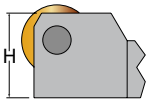

The height of the head. This is used to determine if there may be a tool clearance issue on a CNC lathe turret.

## CH = Center Height

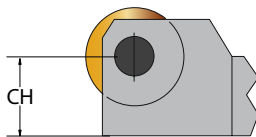

Dimension required to position centerline of tool with the chuck of the lathe.

## Dia. Range

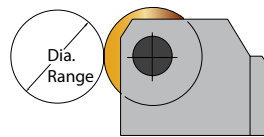

The minimum and maximum diameters suggested to effectively use the knurl tool to produce a good knurl. See individual notes on specifications.

## P = Wheel Projection

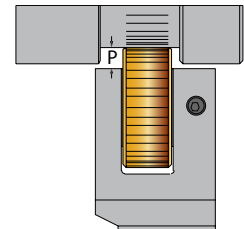

The distance that the wheel protrudes from the holder. This is generally useful when needing to knurl inside a slot or over a shoulder.

## L = Length

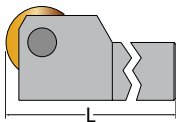

Overall length of tool.

## L1 = Length of Shank

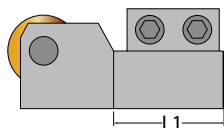

The amount of shank that can be held in the holding mechanism of the turret or tool post.

## L2 = Length of Head

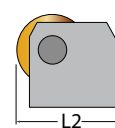

The amount of the tool that protrudes from the holding mechanism. This is relevant for indexing clearance on CNC turrets.



# CNC Modular Knurling Tools

## With the Flexibility of Multiple Knurling Applications!



### Versatility

- **Multi diameter** diamond knurling cutting style
- **Reversible** Head for Right or Left knurling.
- **Heavy duty** knurl cutting and knurl forming
- **Double Wheel** forming knurling head
- **Straddle** forming knurling head
- **Shoulder** forming knurling head
- **Wide diameter** range for small diameter to large diameter parts

### Modular

Multi shank size interchangeable with 8 knurling heads.



### Adjustable

Dovetail knurling head locking system.  
Quick and precise center line setting.  
Knurling wheel angle stationary for diamond cutting

### Two Ways to Knurl

#### Forming (five heads available)

Knurl forming action (material displacement by means of rolling) is generally for special application. It creates a better quality of knurl pattern, but speeds and feeds are sacrificed for this quality. The force applied through forming is increased in larger diameters making knurling difficult and slow.

#### Cutting (three heads available)

Knurl cutting action cuts a perfect knurl pattern 10 to 20 times faster than any conventional knurling tool. It is engineered to knurl any material, including thin wall tubing, with minimum stress to the spindle and work piece. Knurl cutting action speeds up knurling enough to become applicable for CNC use.

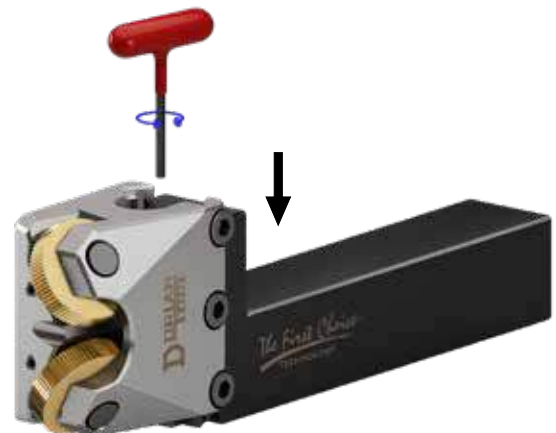

CNC-100-3-M used for examples.

## Knurling Tools Cutting Operation

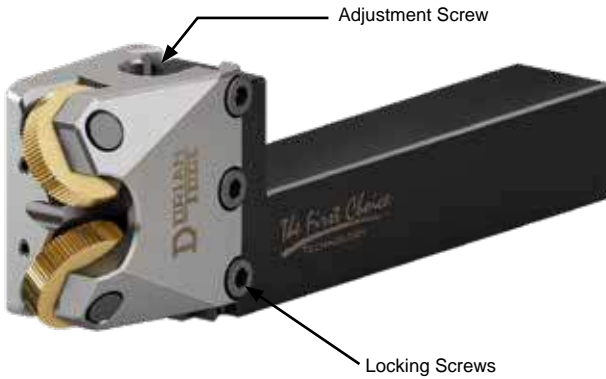

### Mounting to the Machine

Clamp the shank at right angles to the axial center line of the machine. The knurl wheels of the knurling tool head should be set exactly on center.

### To adjust center-height:

1. Loosen the lock screws.
2. Turning the adjustment screw adjusts the head up or down.
3. Turn adjustment screw until the center height is aligned.
4. Lock head back in place by tightening the lock screws.

### Knurling Adjustment Set Up

With the machine spindle rotating slowly, in-feed (Plunge) the tool to make a slight impression for the full width of the cutter. This impression should be equal on both wheels when using Diamond Knurling Head. Misaligned patterns can be corrected by turning the fine adjustment screw in opposite directions.

## Starting Cutting Knurl



- 1) Touch the workpiece diameter with the knurl wheels.









- 2) Move the knurling wheel to the end of the workpiece
  - Set the cutting depth of the wheel (35% of the circular pitch)
  - Start knurl

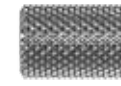

- 3) Use recommended cutting parameter
  - Use coolant

## Knurling head center line adjustments

|   |   |  |
|---|---|--|
| <br>R.H. Spiral   |  | <ul style="list-style-type: none"> <li>• Knurling tool is too low from center line.</li> <li>• Top wheel is cutting a deeper R.H. Diagonal Knurl.</li> <li>• Turn the Fine Center Adjustment Screw until both wheels are on center and touching simultaneously.</li> </ul> |
| <br>L.H. Spiral   |  | <ul style="list-style-type: none"> <li>• Knurling tool is too high from center line.</li> <li>• Bottom wheel is cutting a deeper L.H. Diagonal Knurl.</li> <li>• Turn Fine Center Adjustment Screw until both wheels are on center and touching simultaneously.</li> </ul> |
| <br>Diamond Knurl |  | <ul style="list-style-type: none"> <li>• Tool is on center line.</li> <li>• Both wheels are touching simultaneously, cutting a perfect diamond knurl.</li> </ul>   |

## Full Faced Cutting Knurl Wheel

When cut knurling, a full faced knurl wheel must be used. The edge of the knurl wheel will be cut into the material to be knurled. A sharp edge must be kept to cut a clean and smooth knurl pattern. The knurl wheel can be reground once the edge is dull or chipped.

## Edge Prep



## Wheel Grinding

When the cutting edges of the knurl wheel become dull, re-sharpen them by grinding the cutting face of both wheels evenly. You can also grind forming wheels to desired width, but bevel afterwards.

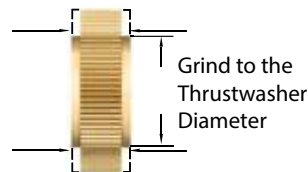

R & M SERIES KNURL WHEEL

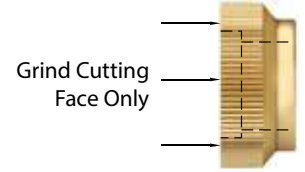

SW SERIES KNURL WHEEL

## Easy to set up Simple to operate.

To minimize set up time of knurling application, and simplify the knurling operation, the CNC Modular Knurling Tool has been engineered to create a diamond knurling pattern, without the need of resetting the knurl wheels every time the workpiece diameter changes.

To cover the full range of diameter three modular cutting knurling head have been developed.

- 1) Small diameter modular head
- 2) Medium diameter modular head
- 3) Large diameter modular head

### Small Diameter Head



### Cutting Range

Small Diameter Cutting Range 1/2" to 1-1/2" (12mm to 38mm)

End feed range: .004" to .012"

- Knurl cutting action
- Twin straight SW series knurl wheels for male diamond pattern
- Supplied with Full Faced SW2S-30-HS knurl wheels - TiN coated

### Medium Diameter



Medium Diameter Cutting Range 1" to 5" (25mm to 127mm)

End feed range: .004" to .016"

- Knurl cutting action
- Two straight R series knurl wheels for male diamond pattern
- Supplied with Full Faced RS-25-HS knurl wheels - TiN coated

### Large Diameter



Large Diameter Cutting Range 2" & up (50mm & up)

End feed range: .004" to .025"

- Knurl cutting action
- Two straight M series knurl wheels for male diamond pattern
- Supplied with Full Faced MS-25-HS knurl wheels - TiN coated

How the diamond CNC Modular Knurling tool works.

- 1) Choose the cutting diameter range of the knurl head
- 2) Set the knurling wheel on centerline of the workpiece
- 3) Touch the workpiece diameter with the knurl wheels.
- 4) Set the depth of cut (35% of the circle pitch)
- 6) Start to cut recommended cutting parameter

# CNC Modular Knurling Tools

- Flexibility
- Multiple combinations
- Multiple applications
- Better performance

**Six  
Modular Shank Sizes**

**Eight  
Modular Heads**

- Designed for the CNC Lathe
- Precision square shank with preset center height
- Right or Left hand applications
- Interchangeable shanks & heads
- High Speed knurl wheels (TiN coated)
- Supplied with heavy duty parts

## 1 Light Duty 60° Diamond Cutting Modular Knurling Head - CNCKH-1-2



Cutting

**Small Diameter Cutting Range 1/2" to 1-1/2" (8mm to 38mm)**

End feed range: .004" to .012"

- Knurl cutting action
- Twin straight SW series knurl wheels for male diamond pattern
- Supplied with Full Faced SW2S-30-HS knurl wheels - TiN coated

## 2 Heavy Duty 60° Diamond Cutting Modular Knurling Head - CNCKH-2-R



Cutting

**Medium Diameter Cutting Range 1" to 5" (25mm to 125mm)**

End feed range: .004" to .016"

- Knurl cutting action
- Two straight R series knurl wheels for male diamond pattern
- Supplied with Full Faced RS-25-HS knurl wheels - TiN coated

## 3 Extra Heavy Duty 60° Diamond Cutting Modular Knurling Head - CNCKH-3-M



Cutting

**Large Diameter Cutting Range 2" & up (50mm & up)**

End feed range: .004" to .025"

- Knurl cutting action
- Two straight M series knurl wheels for male diamond pattern
- Supplied with Full Faced MS-25-HS knurl wheels - TiN coated

## 4 Double Wheel Forming Knurling Modular Head - CNCKH-4-M



Forming

**Diameter Range: 5/16" & up (8mm & up)**

End feed range: .004" to .012"

- Knurl Forming action
- Two M series knurl wheels for straight or diamond pattern
- Supplied with Beveled MDR/L-25-HSB knurl wheels - TiN coated

## 5 Single Wheel Forming Modular Knurling Head - CNCKH-5-O



Forming

**Straight Bump Unlimited Diameter**

End feed range: .004" to .012"

- Knurl forming action
- Single O series knurl wheel for straight or diamond pattern
- Supplied with Beveled OS-25-HSB knurl wheel - TiN coated

## 6 Shoulder Forming Modular Knurling Head - CNCKH-6-4



Forming

**Diameter Range: 5/16" & up (8mm & up)**

End feed range: .004" to .012"

- Knurl forming action
- Two SW series knurl wheels for straight or diamond pattern
- Supplied with Beveled SW4R/L-25-HSB knurl wheels - TiN coated

## 7 Straddle Forming Modular Knurling Head - CNCKH-7-R



Forming

**Diameter Range: up to 1" (25mm)**

End feed range: .004" to .012"

- Knurl forming action
- Two R series knurl wheels for straight or diamond pattern
- Supplied with Beveled RDR/L-30-HSB knurl wheels - TiN coated

## 7-2 Shoulder Style Straddle Forming Modular Knurling Head - CNCKH-7-2



Forming

**Diameter Range: up to 1" (25mm)**

End feed range: .004" to .012"

- Knurl forming action
- Two SW series knurl wheels for straight or diamond pattern
- Supplied with Beveled SW2R/L-30-HSB knurl wheels - TiN coated

## 1 Light Duty 60° Diamond Cutting Modular Knurling Head + CNC Modular Knurling Tool Shank



| Metric      |                       | Shank Size mm | Tool Length | Inch        |                       | Shank Size | Tool Length | Knurl Wheel | Knurl Pin Set |                       | Modular Head Description |
|-------------|-----------------------|---------------|-------------|-------------|-----------------------|------------|-------------|-------------|---------------|-----------------------|--------------------------|
| Description | UPC #                 |               |             | Description | UPC #                 |            |             |             | Description   | UPC #                 |                          |
| CNC-20-1-2  | <a href="#">20405</a> | 20            | 174.65      | CNC-75-1-2  | <a href="#">20410</a> | .750"      | 6 7/8"      | SW2         |               |                       |                          |
| CNC-25-1-2  | <a href="#">20415</a> | 25            | 174.65      | CNC-100-1-2 | <a href="#">20420</a> | 1.000"     | 6 7/8"      | SW2         | SW2.0P-2S     | <a href="#">29055</a> | CNCKH-1-2                |
| CNC-32-1-2  | <a href="#">20425</a> | 32            | 187.325     | CNC-125-1-2 | <a href="#">20430</a> | 1.250"     | 7 3/8"      | SW2         |               |                       |                          |

Supplied with a set of Full Faced straight high speed TiN coated knurl wheels, 30 TPI (.8mm) for a male diamond pattern.

## 2 Heavy Duty 60° Diamond Cutting Modular Knurling Head + CNC Modular Knurling Tool Shank



| Metric      |                       | Shank Size mm | Tool Length | Inch        |                       | Shank Size | Tool Length | Knurl Wheel | Knurl Pin Set |                       | Modular Head Description |
|-------------|-----------------------|---------------|-------------|-------------|-----------------------|------------|-------------|-------------|---------------|-----------------------|--------------------------|
| Description | UPC #                 |               |             | Description | UPC #                 |            |             |             | Description   | UPC #                 |                          |
| CNC-20-2-R  | <a href="#">20505</a> | 20            | 174.65      | CNC-75-2-R  | <a href="#">20510</a> | .750"      | 6 7/8"      | Series R    |               |                       |                          |
| CNC-25-2-R  | <a href="#">20515</a> | 25            | 174.65      | CNC-100-2-R | <a href="#">20520</a> | 1.000"     | 6 7/8"      |             | KPS-25- 87-C  | <a href="#">28925</a> | CNCKH-2-R                |
| CNC-32-2-R  | <a href="#">20525</a> | 32            | 187.325     | CNC-125-2-R | <a href="#">20530</a> | 1.250"     | 7 3/8"      |             |               |                       |                          |

Supplied with a set of Full Faced straight high speed knurl wheels, 25 TPI (1mm) for a male diamond pattern.

## 3 Extra Heavy Duty 60° Diamond Cutting Modular Knurling Head + CNC Modular Knurling Tool Shank

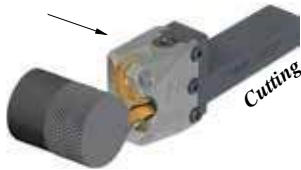

| Metric      |                       | Shank Size mm | Tool Length | Inch        |                       | Shank Size | Tool Length | Knurl Wheel | Knurl Pin Set |                       | Modular Head Description |
|-------------|-----------------------|---------------|-------------|-------------|-----------------------|------------|-------------|-------------|---------------|-----------------------|--------------------------|
| Description | UPC #                 |               |             | Description | UPC #                 |            |             |             | Description   | UPC #                 |                          |
| CNC-20-3-M  | <a href="#">20605</a> | 20            | 177.8       | CNC-75-3-M  | <a href="#">20610</a> | .750"      | 7"          | Series M    |               |                       |                          |
| CNC-25-3-M  | <a href="#">20615</a> | 25            | 177.8       | CNC-100-3-M | <a href="#">20620</a> | 1.000"     | 7"          |             | KPS-31-100-C  | <a href="#">28945</a> | CNCKH-3-M                |
| CNC-32-3-M  | <a href="#">20625</a> | 32            | 190.5       | CNC-125-3-M | <a href="#">20630</a> | 1.250"     | 7 1/2"      |             |               |                       |                          |

Supplied with a set of Full Faced straight high speed TiN coated knurl wheels, 25 TPI (1mm) for a male diamond pattern.

## 4 Double Wheel Forming Modular Knurling Head + CNC Modular Knurling Tool Shank

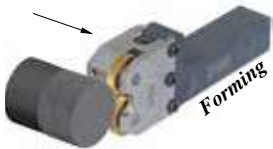

| Metric      |                       | Shank Size mm | Tool Length | Inch        |                       | Shank Size | Tool Length | Knurl Wheel | Knurl Pin Set |                       | Modular Head Description |
|-------------|-----------------------|---------------|-------------|-------------|-----------------------|------------|-------------|-------------|---------------|-----------------------|--------------------------|
| Description | UPC #                 |               |             | Description | UPC #                 |            |             |             | Description   | UPC #                 |                          |
| CNC-20-4-M  | <a href="#">20640</a> | 20            | 177.8       | CNC-75-4-M  | <a href="#">20646</a> | .750"      | 7"          | Series M    |               |                       |                          |
| CNC-25-4-M  | <a href="#">20642</a> | 25            | 177.8       | CNC-100-4-M | <a href="#">20648</a> | 1.000"     | 7"          |             | KPS-31-125-C  | <a href="#">28950</a> | CNCKH-4-M                |
| CNC-32-4-M  | <a href="#">20644</a> | 32            | 190.5       | CNC-125-4-M | <a href="#">20650</a> | 1.250"     | 7 1/2"      |             |               |                       |                          |

Supplied with a set of Beveled diagonal high speed beveled TiN coated knurl wheels, 25 TPI (1mm) for a male diamond pattern.

## 5 Single Wheel Forming Modular Knurling Head + CNC Modular Knurling Tool Shank



| Metric      |                       | Shank Size mm | Tool Length | Inch        |                       | Shank Size | Tool Length | Knurl Wheel | Knurl Pin Set |                       | Modular Head Description |
|-------------|-----------------------|---------------|-------------|-------------|-----------------------|------------|-------------|-------------|---------------|-----------------------|--------------------------|
| Description | UPC #                 |               |             | Description | UPC #                 |            |             |             | Description   | UPC #                 |                          |
| CNC-20-5-O  | <a href="#">20705</a> | 20            | 171.45      | CNC-75-5-O  | <a href="#">20710</a> | .750"      | 6 3/4"      | Series O    |               |                       |                          |
| CNC-25-5-O  | <a href="#">20715</a> | 25            | 171.45      | CNC-100-5-O | <a href="#">20720</a> | 1.000"     | 6 3/4"      |             | KPS-31-125-C  | <a href="#">28950</a> | CNCKH-5-O                |
| CNC-32-5-O  | <a href="#">20725</a> | 32            | 184.15      | CNC-125-5-O | <a href="#">20730</a> | 1.250"     | 7 1/4"      |             |               |                       |                          |

Supplied with one Beveled straight high speed beveled TiN coated knurl wheel, 25 TPI (1mm) for a straight pattern.

## 6 Shoulder Forming Modular Knurling Head + CNC Modular Knurling Tool Shank

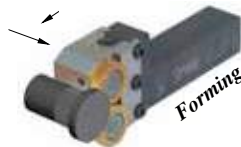

| Metric      |                       | Shank Size mm | Tool Length | Inch        |                       | Shank Size | Tool Length | Knurl Wheel | Knurl Pin Set |                       | Modular Head Description |
|-------------|-----------------------|---------------|-------------|-------------|-----------------------|------------|-------------|-------------|---------------|-----------------------|--------------------------|
| Description | UPC #                 |               |             | Description | UPC #                 |            |             |             | Description   | UPC #                 |                          |
| CNC-20-6-4  | <a href="#">20775</a> | 20            | 171.45      | CNC-75-6-4  | <a href="#">20780</a> | .750"      | 6 3/4"      | Series SW4  |               |                       |                          |
| CNC-25-6-4  | <a href="#">20785</a> | 25            | 171.45      | CNC-100-6-4 | <a href="#">20790</a> | 1.000"     | 6 3/4"      |             | SW4.0P-2S     | <a href="#">29085</a> | CNCKH-6-4                |
| CNC-32-6-4  | <a href="#">20795</a> | 32            | 184.15      | CNC-125-6-4 | <a href="#">20800</a> | 1.250"     | 7 1/4"      |             |               |                       |                          |

Supplied with a set of Beveled diagonal high speed beveled TiN coated knurl wheels, 25 TPI (1mm) for a male diamond pattern.

## 7-R Straddle Forming Modular Knurling Head + CNC Modular Knurling Tool Shank

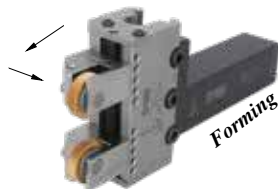

| Metric      |                       | Shank Size mm | Tool Length | Inch        |                       | Shank Size | Tool Length | Knurl Wheel | Knurl Pin Set |                       | Modular Head Description |
|-------------|-----------------------|---------------|-------------|-------------|-----------------------|------------|-------------|-------------|---------------|-----------------------|--------------------------|
| Description | UPC #                 |               |             | Description | UPC #                 |            |             |             | Description   | UPC #                 |                          |
| CNC-20-7-R  | <a href="#">20905</a> | 20            | 187.325     | CNC-75-7-R  | <a href="#">20910</a> | .750"      | 7 1/8"      | Series R    |               |                       |                          |
| CNC-25-7-R  | <a href="#">20915</a> | 25            | 187.325     | CNC-100-7-R | <a href="#">20920</a> | 1.000"     | 7 3/8"      |             | KPS-25-75-C   | <a href="#">28915</a> | CNCKH-7-R                |
| CNC-32-7-R  | <a href="#">20925</a> | 32            | 187.325     | CNC-125-7-R | <a href="#">20930</a> | 1.250"     | 7 7/8"      |             |               |                       |                          |

Supplied with a set of Beveled diagonal high speed beveled TiN coated knurl wheels, 30 TPI (.8mm) for a male diamond pattern.

## 7-2 Shoulder Style Straddle Forming Knurling Head + CNC Modular Knurling Tool Shank

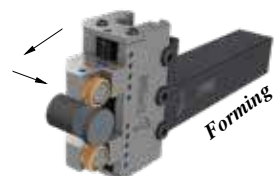

| Metric      |       | Shank Size mm | Tool Length | Inch        |       | Shank Size | Tool Length | Knurl Wheel | Knurl Pin Set |                       | Modular Head Description |
|-------------|-------|---------------|-------------|-------------|-------|------------|-------------|-------------|---------------|-----------------------|--------------------------|
| Description | UPC # |               |             | Description | UPC # |            |             |             | Description   | UPC #                 |                          |
| CNC-20-7-2  | 20935 | 20            | 182.88      | CNC-75-7-2  | 20940 | .750"      | 7 1/8"      | Series SW2  |               |                       |                          |
| CNC-25-7-2  | 20945 | 25            | 182.88      | CNC-100-7-2 | 20950 | 1.000"     | 7 1/8"      |             | SW2.0P-2S     | <a href="#">29055</a> | CNCKH-7-2                |
| CNC-32-7-2  | 20955 | 32            | 193.675     | CNC-125-7-2 | 20960 | 1.250"     | 7 5/8"      |             |               |                       |                          |

Supplied with a set of Beveled diagonal high speed beveled TiN coated knurl wheels, 30 TPI (.8mm) for a male diamond pattern.

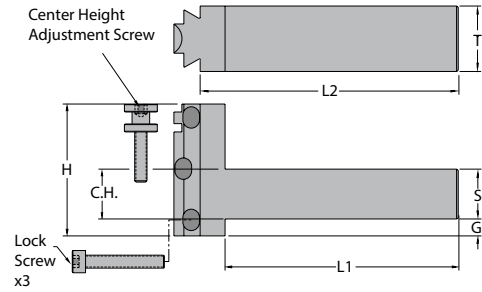

## CNC Modular Knurling Tool Shank

| Shank Inch  |                       | C.H. & S<br>inch | G     | H     | L1    | L2    | T     | Adjustment Screw |                       | Lock Screw Set of 3 |                       |
|-------------|-----------------------|------------------|-------|-------|-------|-------|-------|------------------|-----------------------|---------------------|-----------------------|
| Description | UPC #                 |                  |       |       |       |       |       | Description      | UPC #                 | Description         | UPC #                 |
| CNC-75*     | <a href="#">21010</a> | 0.750"           | 0.250 | 2.000 | 4.500 | 4.875 | 1.000 | CNC-1175         | <a href="#">28505</a> | CNC-1024**          | <a href="#">28515</a> |
| CNC-100*    | <a href="#">21020</a> | 1.000"           | -     | 2.000 | 4.500 | 4.875 | 1.000 |                  |                       |                     |                       |
| CNC-125*    | <a href="#">21030</a> | 1.250"           | -     | 2.250 | 5.000 | 5.375 | 1.000 |                  |                       |                     |                       |

| Shank Metric |                       | C.H. & S<br>inch | G   | H    | L1    | L2    | T    | Adjustment Screw |                       | Lock Screw Set |                       |
|--------------|-----------------------|------------------|-----|------|-------|-------|------|------------------|-----------------------|----------------|-----------------------|
| Description  | UPC #                 |                  |     |      |       |       |      | Description      | UPC #                 | Description    | UPC #                 |
| CNC-20*      | <a href="#">21005</a> | 20mm             | 5.4 | 50.0 | 114.3 | 123.8 | 25.4 | CNC-1175         | <a href="#">28505</a> | CNC-1024**     | <a href="#">28515</a> |
| CNC-25*      | <a href="#">21015</a> | 25mm             | -   | 50.0 | 114.3 | 123.8 | 25.4 |                  |                       |                |                       |
| CNC-32*      | <a href="#">21025</a> | 32mm             | -   | 57.2 | 127.0 | 136.5 | 25.4 |                  |                       |                |                       |

\* Supplied with lock screw set and adjustment screw

\*\* One (1) set includes three (3) lock screws

## CNC Knurling Heads

Cutting

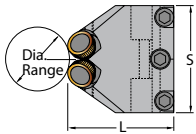
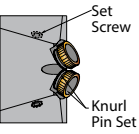
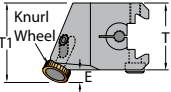

### 1 Light Duty 60° Diamond Cutting Knurling Head

| Head<br>Description | UPC #                 | System | Dia.<br>Range   | E     | L     | S     | T     | T1    | Knurl<br>Wheel<br>Series | Knurl Pin Set |                       | Set<br>Screw |
|---------------------|-----------------------|--------|-----------------|-------|-------|-------|-------|-------|--------------------------|---------------|-----------------------|--------------|
|                     |                       |        |                 |       |       |       |       |       |                          | Description   | UPC #                 |              |
| CNCKH-1-2           | <a href="#">21035</a> | inch   | .500" to 1.500" | 0.250 | 1.960 | 2.000 | 1.250 | 1.500 | SW2*                     | SW2.0P-2S**   | <a href="#">29055</a> | M4-.7x4      |
|                     |                       | mm     | 12 to 38mm      | 6.4   | 49.8  | 50.8  | 31.8  | 38.1  |                          |               |                       |              |

\* Supplied with two (2) full faced straight high speed TiN coated knurl wheels for a male diamond pattern, 30 TPI (0.8mm)  
\*\* One (1) set includes two (2) knurling pins and washers

**Male 60° diamond pattern with straight wheels.**



Cutting

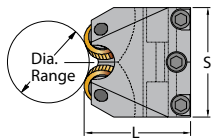
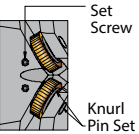
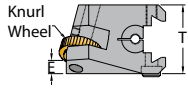

### 2 Heavy Duty 60° Diamond Cutting Knurling Head

| Head<br>Description | UPC #                 | System | Dia.<br>Range  | E     | L     | S     | T     | Knurl<br>Wheel<br>Series | Knurl Pin Set |                       | Set<br>Screw |
|---------------------|-----------------------|--------|----------------|-------|-------|-------|-------|--------------------------|---------------|-----------------------|--------------|
|                     |                       |        |                |       |       |       |       |                          | Description   | UPC #                 |              |
| CNCKH-2-R           | <a href="#">21040</a> | inch   | 1.00" to 5.00" | 0.312 | 1.960 | 2.000 | 1.250 | R*                       | KPS-25-87-C** | <a href="#">28925</a> | M4-.7x4      |
|                     |                       | mm     | 25 to 127mm    | 7.9   | 49.8  | 50.8  | 31.8  |                          |               |                       |              |

\* Supplied with two (2) full faced straight high speed TiN coated knurl wheels for a male diamond pattern, 25 TPI (1.00mm)  
\*\* One (1) set includes one (1) knurling pin and two (2) washers

**Male 60° diamond pattern with straight wheels.**



Cutting

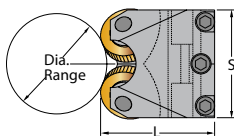
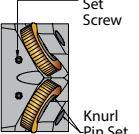
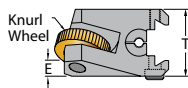

### 3 Extra H.D. 60° Diamond Cutting Knurling Head

| Head<br>Description | UPC #                 | System | Dia.<br>Range | E     | L     | S     | T     | Knurl<br>Wheel<br>Series | Knurl Pin Set  |                       | Set<br>Screw |
|---------------------|-----------------------|--------|---------------|-------|-------|-------|-------|--------------------------|----------------|-----------------------|--------------|
|                     |                       |        |               |       |       |       |       |                          | Description    | UPC #                 |              |
| CNCKH-3-M           | <a href="#">21045</a> | inch   | 2.0" & up     | 0.312 | 2.125 | 2.000 | 1.250 | M*                       | KPS-31-100-C** | <a href="#">28945</a> | M4-.7x4      |
|                     |                       | mm     | 50mm & up     | 7.9   | 54.0  | 50.8  | 31.8  |                          |                |                       |              |

\* Supplied with two (2) full faced straight high speed TiN coated knurl wheels for a male diamond pattern, 25 TPI (1.00mm)  
\*\* One (1) set includes one (1) pin and two (2) washers

**Male 60° diamond pattern with straight wheels.**



Forming

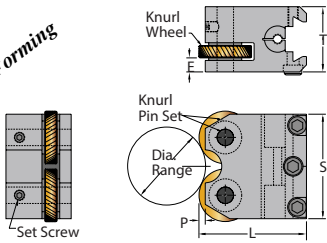

#### 4 Double Wheel Forming Knurling Head

| Head        |       |        |               |       |       |       |       |       |             | Knurl Wheel Series | Knurl Pin Set |         | Set Screw |
|-------------|-------|--------|---------------|-------|-------|-------|-------|-------|-------------|--------------------|---------------|---------|-----------|
| Description | UPC # | System | Dia. Range    | E     | L     | P     | S     | T     | Description |                    | UPC #         |         |           |
| CNCKH-4-M   | 28947 | inch   | .313" & up*** | 0.265 | 2.125 | 0.120 | 2.000 | 1.250 | M*          | KPS-31-125-C**     | 28950         | M5-.8x8 |           |
|             |       | mm     | 8mm & up***   | 6.7   | 54.0  | 3.0   | 50.8  | 31.8  |             |                    |               |         |           |

\* Supplied with one (1) set of beveled diagonal high speed TiN coated knurl wheels for a diamond pattern, 25 TPI (1.00mm)  
 \*\* One (1) set includes one (1) knurling pin and two (2) washers  
 \*\*\* Warning: May cause deflection on small part diameters, and too much pressure on large diameters

**Straight pattern**  
with straight wheels



**Male 60° diamond pattern**  
with diagonal wheels



Forming

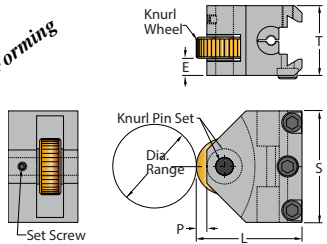

#### 5 Single Wheel Forming Knurling Head

| Head        |       |        |              |       |       |       |       |       |             | Knurl Wheel Series | Knurl Pin Set |         | Set Screw |
|-------------|-------|--------|--------------|-------|-------|-------|-------|-------|-------------|--------------------|---------------|---------|-----------|
| Description | UPC # | System | Dia. Range   | E     | L     | P     | S     | T     | Description |                    | UPC #         |         |           |
| CNCKH-5-O   | 21050 | inch   | Unlimited*** | 0.312 | 1.875 | 0.188 | 2.000 | 1.250 | O*          | KPS-31-125-C**     | 28950         | M4-.7x6 |           |
|             |       | mm     | Unlimited*** | 7.9   | 47.6  | 4.7   | 50.8  | 31.8  |             |                    |               |         |           |

\* Supplied with one (1) beveled straight TiN coated knurl wheel for a straight pattern, 25 TPI (1.00mm)  
 \*\* One (1) set includes one (1) knurling pin and two (2) washers  
 \*\*\* Warning: May cause deflection on small part diameters, and too much pressure on large diameters

**Straight pattern**  
with straight wheel



**Female diamond pattern**  
with male diamond wheel



**Male diamond pattern**  
with female diamond wheel



Forming

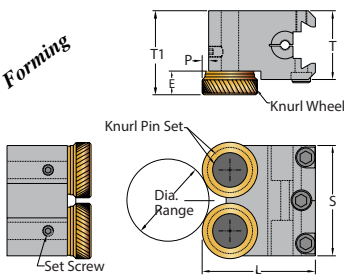

#### 6 Shoulder Forming Knurling Head

| Head        |       |        |               |       |       |       |       |       |       |             | Knurl Wheel Series | Knurl Pin Set |         | Set Screw |
|-------------|-------|--------|---------------|-------|-------|-------|-------|-------|-------|-------------|--------------------|---------------|---------|-----------|
| Description | UPC # | System | Dia. Range    | E     | L     | P     | S     | T     | T1    | Description |                    | UPC #         |         |           |
| CNCKH-6-4   | 21056 | inch   | .312" & up*** | 0.375 | 1.875 | 0.050 | 2.000 | 1.250 | 1.500 | SW4*        | SW4.0P-2S**        | 29085         | M5-.8x8 |           |
|             |       | mm     | 8mm & up***   | 9.5   | 47.6  | 1.3   | 50.8  | 31.8  | 38.1  |             |                    |               |         |           |

\* Supplied with one (1) set of beveled diagonal high speed TiN coated knurl wheels for a male diamond pattern, 25 TPI (1.00mm)  
 \*\* One (1) set includes two (2) knurling pins and washers  
 \*\*\* Warning: May cause deflection on small part diameters, and too much pressure on large diameters

**Straight pattern**  
with straight wheels



**Male 60° diamond pattern**  
with diagonal wheels



Forming

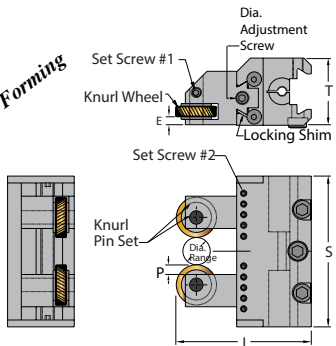

#### 7 Straddle Forming Knurling Head

| Head        |       |        |               |       |       |       |       |       |             | Knurl Wheel Series | Knurl Pin Set |         | Set Screw #1 | Set Screw #2 |
|-------------|-------|--------|---------------|-------|-------|-------|-------|-------|-------------|--------------------|---------------|---------|--------------|--------------|
| Description | UPC # | System | Dia. Range    | E     | L     | P     | S     | T     | Description |                    | UPC #         |         |              |              |
| CNCKH-7-R   | 21060 | inch   | up to 1.0**** | 0.120 | 2.500 | 0.175 | 2.875 | 1.250 | R*          | KPS-25-75-C**      | 28920         | M4-.7x4 | M3-.5x3      |              |
|             |       | mm     | up to 25mm*** | 3.0   | 63.5  | 4.4   | 73.0  | 31.8  |             |                    |               |         |              |              |

\* Supplied with one (1) set of beveled diagonal high speed TiN coated knurl wheels for a male diamond pattern, 30 TPI (0.8mm)  
 \*\* One (1) set includes one (1) knurling pin and two (2) washers  
 \*\*\* The tool has the capability to adjust the wheels until they touch, but physically applying a knurl on the smallest diameters may not be possible

**Straight pattern**  
with straight wheels



**Male 60° diamond pattern**  
with diagonal wheels



Forming

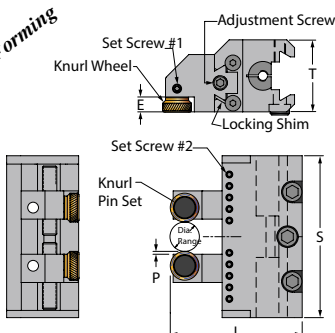

#### 8 Straddle Forming Knurling Head

| Head        |       |        |               |       |       |       |       |       |             | Knurl Wheel Series | Knurl Pin Set |         | Set Screw #1 | Set Screw #2 |
|-------------|-------|--------|---------------|-------|-------|-------|-------|-------|-------------|--------------------|---------------|---------|--------------|--------------|
| Description | UPC # | System | Dia. Range    | E     | L     | P     | S     | T     | Description |                    | UPC #         |         |              |              |
| CNCKH-7-2   | 21065 | inch   | up to 1.0***  | 0.265 | 2.290 | 0.050 | 2.875 | 1.250 | SW2*        | SW2.0P-2S          | 29055         | M4-.7x4 | M3-.5x3      |              |
|             |       | mm     | up to 25mm*** | 6.7   | 58.2  | 1.3   | 73.0  | 31.8  |             |                    |               |         |              |              |

\* Supplied with one (1) set of beveled diagonal high speed TiN coated knurl wheels to make a male diamond pattern, 30 TPI (0.8mm)  
 \*\* One (1) set includes two (2) knurling pins and washers  
 \*\*\* The tool has the capability to adjust the wheels until they touch, but physically applying a knurl on the smallest diameters may not be possible

**Straight pattern**  
with straight wheels



**Male 60° diamond pattern**  
with diagonal wheels



## 1 SMALL Light Duty 60° Diamond Cutting Modular Knurling Head - SCNCKH-1-2



**Small Cutting Range 1/2" to 1-1/2" (8mm to 38mm)**

End feed range: .004" to .012"

- Knurl cutting action
- Twin straight SW series knurl wheels for male diamond pattern
- Supplied with full faced SW2S-30-HS knurl wheels - TiN coated

## 6 SMALL Shoulder Forming Modular Knurling Head - SCNCKH-6-2

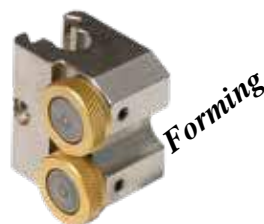

**Diameter Range: 1/4" & up (6,4mm & up)**

End feed range: .004" to .012"

- Knurl forming action
- Twin SW series knurl wheels for straight or diamond pattern
- Supplied with beveled SW2R/L-25-HSB knurl wheels - TiN coated

## 7-R SMALL Straddle Forming Modular Knurling Head - SCNCKH-7-D



**Diameter Range: up to 5/8" (16mm)**

End feed range: .004" to .012"

- Knurl forming action
- Twin D series knurl wheels for straight or diamond pattern
- Supplied with beveled DR/L-30-HSB knurl wheels - TiN coated

## 7-2 SMALL Shoulder Style Straddle Forming Modular Knurling Head - SCNCKH-7-2

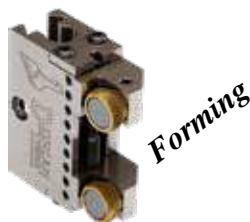

**Diameter Range: up to 5/8" (16mm)**

End feed range: .004" to .012"

- Knurl forming action
- Twin SW series knurl wheels for straight or diamond pattern
- Supplied with beveled SW2R/L-30-HSB knurl wheels - TiN coated



1 SMALL Light Duty 60° Diamond Cutting Modular Knurling Head + SMALL CNC Modular Knurling Tool Shank



| Metric       |                       |               | Tool Length | Inch         |                       |            | Tool Length | Knurl Wheel | Knurl Pin Set |                       | Modular Head Description |
|--------------|-----------------------|---------------|-------------|--------------|-----------------------|------------|-------------|-------------|---------------|-----------------------|--------------------------|
| Description  | UPC #                 | Shank Size mm |             | Description  | UPC #                 | Shank Size |             |             | Description   | UPC #                 |                          |
| SCNC-10-1-2  | <a href="#">20005</a> | 10            | 4"          | SCNC-37-1-2  | <a href="#">20010</a> | 3/8"       | 4"          | SW2         |               |                       |                          |
| SCNC-12-1-2  | <a href="#">20015</a> | 12            | 4-1/4"      | SCNC-50-1-2  | <a href="#">20020</a> | 1/2"       | 4-1/4"      | SW2         | SW2.0P-2S     | <a href="#">29055</a> | SCNCKH-1-2               |
| SCNC-162-1-2 | <a href="#">20025</a> | 16            | 4-1/4"      | SCNC-162-1-2 | <a href="#">20025</a> | 5/8"       | 4-1/4"      | SW2         |               |                       |                          |

Supplied with a set of Full Faced straight high speed TiN coated knurl wheels, 30 TPI (.8mm) for a male diamond pattern

6 SMALL Shoulder Forming Modular Knurling Head + SMALL CNC Modular Knurling Tool Shank

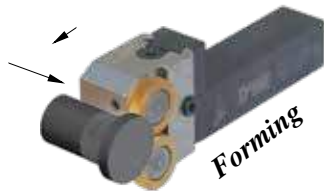

| Metric       |                       |               | Tool Length | Inch         |                       |            | Tool Length | Knurl Wheel | Knurl Pin Set |                       | Modular Head Description |
|--------------|-----------------------|---------------|-------------|--------------|-----------------------|------------|-------------|-------------|---------------|-----------------------|--------------------------|
| Description  | UPC #                 | Shank Size mm |             | Description  | UPC #                 | Shank Size |             |             | Description   | UPC #                 |                          |
| SCNC-10-6-2  | <a href="#">20105</a> | 10            | 101.6       | SCNC-37-6-2  | 20110                 | 3/8"       | 4"          | Series SW4  |               |                       |                          |
| SCNC-12-6-2  | 20115                 | 12            | 107.95      | SCNC-50-6-2  | <a href="#">20120</a> | 1/2"       | 4-1/4"      |             | SW2.0P-2S     | <a href="#">29055</a> | SCNCKH-6-2               |
| SCNC-162-6-2 | <a href="#">20125</a> | 16            | 107.95      | SCNC-162-6-2 | <a href="#">20125</a> | 5/8"       | 4-1/4"      |             |               |                       |                          |

Supplied with a set of Beveled diagonal high speed TiN coated knurl wheels, 25 TPI (1mm) for a male diamond pattern

7-D SMALL Straddle Forming Modular Knurling Head + SMALL CNC Modular Knurling Tool Shank



| Metric       |                       |               | Tool Length | Inch         |                       |            | Tool Length | Knurl Wheel | Knurl Pin Set |                       | Modular Head Description |
|--------------|-----------------------|---------------|-------------|--------------|-----------------------|------------|-------------|-------------|---------------|-----------------------|--------------------------|
| Description  | UPC #                 | Shank Size mm |             | Description  | UPC #                 | Shank Size |             |             | Description   | UPC #                 |                          |
| SCNC-10-7-D  | <a href="#">20205</a> | 10            | 114.3       | SCNC-37-7-D  | <a href="#">20210</a> | 3/8"       | 4-1/2"      | Series D    |               |                       |                          |
| SCNC-12-7-D  | <a href="#">20215</a> | 12            | 120.65      | SCNC-50-7-D  | <a href="#">20220</a> | 1/2"       | 4-3/4"      |             | KPS-18-50-C   | <a href="#">28905</a> | SCNCKH-7-D               |
| SCNC-162-7-D | <a href="#">20225</a> | 16            | 120.65      | SCNC-162-7-D | <a href="#">20225</a> | 5/8"       | 4-3/4"      |             |               |                       |                          |

Supplied with a set of Beveled diagonal high speed TiN coated knurl wheels, 30 TPI (8mm) for a male diamond pattern

7-2 SMALL Shoulder Style Straddle Forming Modular Knurling Head + SMALL CNC Modular Knurling Tool Shank

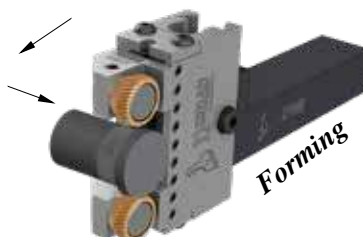

| Metric       |       |               | Tool Length | Inch         |       |            | Tool Length | Knurl Wheel | Knurl Pin Set |                       | Modular Head Description |
|--------------|-------|---------------|-------------|--------------|-------|------------|-------------|-------------|---------------|-----------------------|--------------------------|
| Description  | UPC # | Shank Size mm |             | Description  | UPC # | Shank Size |             |             | Description   | UPC #                 |                          |
| SCNC-10-7-2  | 20275 | 10            | 114.3       | SCNC-37-7-2  | 20280 | 3/8"       | 4 1/2"      | Series SW2  |               |                       |                          |
| SCNC-12-7-2  | 20285 | 12            | 120.65      | SCNC-50-7-2  | 20290 | 1/2"       | 4 3/4"      |             | SW2.0P-2S     | <a href="#">29055</a> | SCNCKH-8-2               |
| SCNC-162-7-2 | 20295 | 16            | 120.65      | SCNC-162-7-2 | 20295 | 5/8"       | 4 3/4"      |             |               |                       |                          |

Supplied with a set of Beveled diagonal high speed TiN coated knurl wheels, 30 TPI (.8mm) for a male diamond pattern

# SMALL CNC Modular Knurling Tool Shank



- Easy set-up
- High productivity
- Best knurl quality
- Long knurl wheel life
- Low production cost
- Specifically designed for the CNC Lathe
- Precision square shank with preset center height
- Right or Left hand applications
- Shanks and heads are all interchangeable
- High Speed knurl wheels (TiN coated)
- Carbide knurl pin
- Center height adjustment

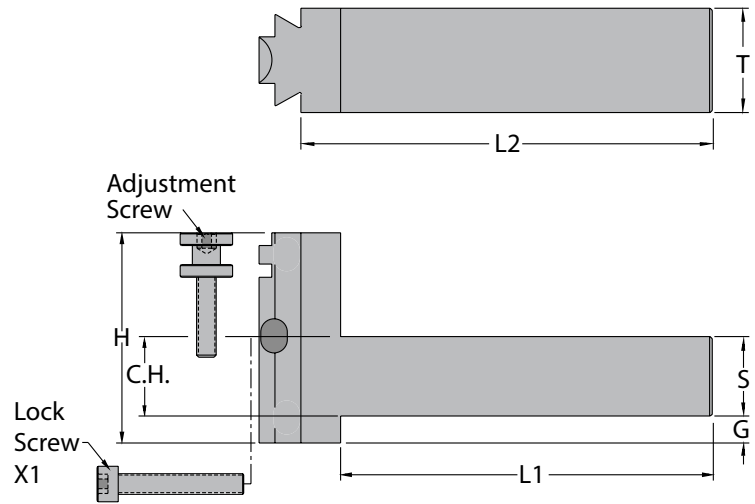

| Shank Inch | UPC #                 | C.H. & S | G     | H     | L1    | L2    | T     | Adjustment Screw |                       | Lock Screw  |                       |
|------------|-----------------------|----------|-------|-------|-------|-------|-------|------------------|-----------------------|-------------|-----------------------|
|            |                       |          |       |       |       |       |       | Description      | UPC #                 | Description | UPC #                 |
| SCNC-37*   | <a href="#">20310</a> | 0.375"   | 0.115 | 1.000 | 2.500 | 2.685 | 0.750 |                  |                       |             |                       |
| SCNC-50*   | <a href="#">20320</a> | 0.500"   | 0.000 | 1.000 | 2.750 | 2.935 | 0.750 | SCNC-875         | <a href="#">28510</a> | SCNC-832    | <a href="#">28520</a> |
| SCNC-162*  | <a href="#">20325</a> | 0.625"   | 0.000 | 1.125 | 2.750 | 2.935 | 0.750 |                  |                       |             |                       |

| Shank metric | UPC #                 | C.H. & S | G   | H    | L1   | L2   | T    | Adjustment Screw |                       | Lock Screw Set of 3 |                       |
|--------------|-----------------------|----------|-----|------|------|------|------|------------------|-----------------------|---------------------|-----------------------|
|              |                       |          |     |      |      |      |      | Description      | UPC #                 | Description         | UPC #                 |
| SCNC-10      | <a href="#">20305</a> | 10       | 2.4 | 25.4 | 63.5 | 68.2 | 19.1 |                  |                       |                     |                       |
| SCNC-12      | <a href="#">20315</a> | 12       | 0.4 | 25.4 | 69.9 | 74.5 | 19.1 | SCNC-875         | <a href="#">28510</a> | SCNC-832            | <a href="#">28520</a> |
| SCNC-162     | <a href="#">20325</a> | 16       | 0.0 | 28.6 | 69.9 | 74.5 | 19.1 |                  |                       |                     |                       |

\* Modular shank supplied with adjustment screw and screw lock

Cutting

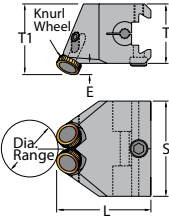
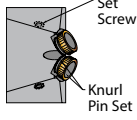

### 1 SMALL Light Duty 60° Diamond Cutting Knurling Head

| Head       | UPC # | System | Dia. Range      | E     | L     | S     | T     | T1    | Knurl Wheel Series | Knurl Pin Set |       | Set Screw |
|------------|-------|--------|-----------------|-------|-------|-------|-------|-------|--------------------|---------------|-------|-----------|
|            |       |        |                 |       |       |       |       |       |                    | Description   | UPC # |           |
| SCNCKH-1-2 | 20335 | inch   | .500" to 1.500" | 0.200 | 1.350 | 1.000 | 0.750 | 0.950 | SW2*               | SW2.0P-2S**   | 29055 | M4-.7x4   |
|            |       | mm     | 12 to 38 mm     | 5.1   | 34.3  | 25.4  | 19.1  | 24.1  |                    |               |       |           |

\*Supplied with one (1) set of full faced straight high speed TiN coated knurl wheels for a male diamond pattern, 30 TPI (0.8mm)  
 \*\* One (1) set includes two (2) knurling pins and washers

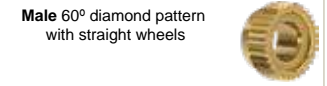

Forming

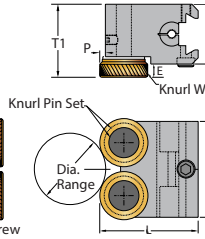
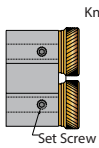

### 6 SMALL Shoulder Forming Knurling Head

| Head       | UPC # | System | Dia. Range     | E     | L     | P     | S     | T     | T1    | Knurl Wheel Series | Knurl Pin Set |       | Set Screw |
|------------|-------|--------|----------------|-------|-------|-------|-------|-------|-------|--------------------|---------------|-------|-----------|
|            |       |        |                |       |       |       |       |       |       |                    | Description   | UPC # |           |
| SCNCKH-6-2 | 20340 | inch   | .250" & up *** | 0.040 | 1.270 | 0.050 | 1.000 | 0.750 | 0.790 | SW2*               | SW2.0P-2S**   | 29055 | M3-.5x3   |
|            |       | mm     | 6.4mm & up *** | 1.0   | 32.3  | 1.3   | 25.4  | 19.1  | 20.1  |                    |               |       |           |

\* Supplied with one (1) set of beveled diagonal high speed TiN coated knurl wheels for a male diamond pattern, 30 TPI (0.8mm)  
 \*\* One (1) set includes two (2) knurling pins and washers  
 \*\*\* Warning: May cause deflection on small part diameters, and too much pressure on large diameters

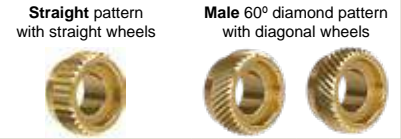

Forming

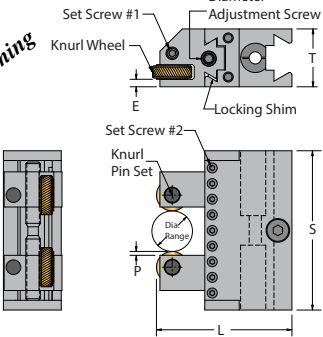

### 7 SMALL Straddle Forming Knurling Head

| Head       | UPC # | System | Dia. Range     | E     | L     | P     | S     | T     | Knurl Wheel Series | Knurl Pin Set |       | Set Screw |         |
|------------|-------|--------|----------------|-------|-------|-------|-------|-------|--------------------|---------------|-------|-----------|---------|
|            |       |        |                |       |       |       |       |       |                    | Description   | UPC # | #1        | #2      |
| SCNCKH-7-D | 20345 | inch   | up to .625**** | 0.125 | 1.815 | 0.098 | 2.062 | 0.750 | D*                 | KPS-18-50-C** | 28905 | M4-.7x4   | M3-.5x3 |
|            |       | mm     | up to 16mm***  | 3.2   | 46.1  | 2.5   | 52.4  | 19.1  |                    |               |       |           |         |

\* Supplied with one (1) set of beveled diagonal high speed TiN coated knurl wheels for a male diamond pattern, 30 TPI (0.8mm)  
 \*\* One (1) set includes one (1) knurling pin and two (2) washers  
 \*\*\* Warning: The tool has the capability to adjust the wheels until they touch, but physically applying a knurl on the smallest diameters may not be possible

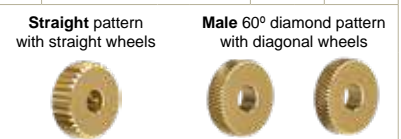

Forming

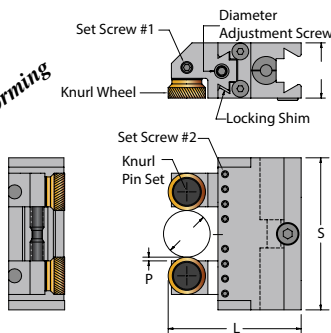

### 8 SMALL Shoulder Style Straddle Forming Modular Knurling Head

| Head       | UPC # | System | Dia. Range    | E     | L     | P     | S     | T     | Knurl Wheel Series | Knurl Pin Set |       | Set Screw |         |
|------------|-------|--------|---------------|-------|-------|-------|-------|-------|--------------------|---------------|-------|-----------|---------|
|            |       |        |               |       |       |       |       |       |                    | Description   | UPC # | #1        | #2      |
| SCNCKH-7-2 | 20346 | inch   | up to .625*** | 0.265 | 1.780 | 0.050 | 2.062 | 0.750 | SW2*               | SW2.0P-2S**   | 29055 | M4-.7x4   | M3-.5x3 |
|            |       | mm     | up to 16mm*** | 6.7   | 45.2  | 1.3   | 52.4  | 19.1  |                    |               |       |           |         |

\*Supplied with one (1) set of beveled diagonal high speed TiN coated knurl wheels to make a male diamond pattern, 30 TPI (0.8mm)  
 \*\*One (1) set includes two (2) knurling pins and washers  
 \*\*\*The tool has the capability to adjust the wheels until they touch, but physically applying a knurl on the smallest diameters may not be possible.



# Straight Cutting Knurling Tool

## 107ST - Straight Cutting Knurling Tool With A Square Shank For CNC



- Knurl cutting action exerts minimum stress on the machine, and is faster than knurl forming action
- Single diagonal R or M series knurl wheel for a straight pattern
- Higher rigidity for larger diameters
- Knurl wheel is mounted between thrust washers to ensure a smooth and even rotation of the knurl
- Right or left hand shank
- Preset center height for CNC

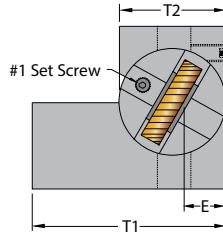

## Resulting Knurl Pattern

Straight pattern with diagonal Left Hand wheel



Left

## Recommended Use:

For best results, use sharp (full faced) knurl wheel. In-feed the knurl 1/8" on end of the part until the correct pattern is generated, then end-feed.

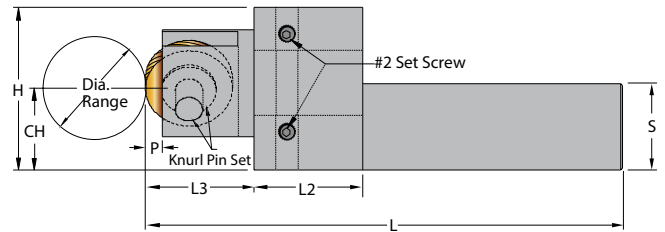
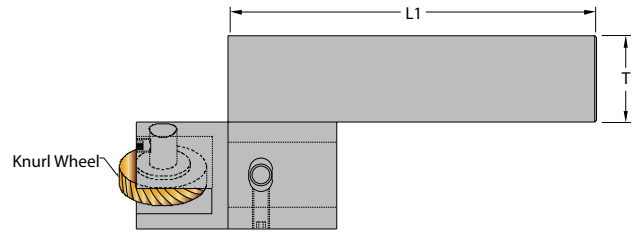

| Inch Description  | UPC # |                       | CH & S inch | Dia. Range   | E    | H     | L     | L1    | L2    | L3    | P    | T     | T1    | T2    | Knurl Wheel Series | Knurl Pin Set |                       | Set Screw |          |
|-------------------|-------|-----------------------|-------------|--------------|------|-------|-------|-------|-------|-------|------|-------|-------|-------|--------------------|---------------|-----------------------|-----------|----------|
|                   | R.H.  | L.H.                  |             |              |      |       |       |       |       |       |      |       |       |       |                    | Desc.         | UPC #                 | No. 1     | No. 2    |
| 107ST-50-R-RH/LH  | 21110 | <a href="#">21210</a> | 0.500       | Unlimited*** | .375 | 1.375 | 3.875 | 3.000 | 1.250 | 0.875 | .125 | 0.500 | 1.500 | 1.000 | RDL*               | KPS-25-100-C  | <a href="#">28930</a> | M4-.7x4   | M5-.8x8  |
| 107ST-162-R-RH/LH | 21115 | <a href="#">21215</a> | 0.625       | Unlimited*** | .375 | 1.500 | 3.875 | 3.000 | 1.250 | 0.875 | .125 | 0.625 | 1.625 | 1.000 | RDL*               | KPS-25-100-C  | <a href="#">28930</a> | M4-.7x4   | M5-.8x8  |
| 107ST-75-M-RH/LH  | 21130 | <a href="#">21230</a> | 0.750       | Unlimited*** | .480 | 1.625 | 4.500 | 3.250 | 1.250 | 1.250 | .190 | 0.750 | 2.000 | 1.250 | MDL**              | KPS-31-125-C  | <a href="#">28950</a> | M4-.7x4   | M5-.8x12 |
| 107ST-100-M-RH/LH | 21140 | <a href="#">21240</a> | 1.000       | Unlimited*** | .480 | 1.875 | 5.500 | 4.250 | 1.250 | 1.250 | .190 | 1.000 | 2.250 | 1.250 | MDL**              | KPS-31-125-C  | <a href="#">28950</a> | M4-.7x4   | M5-.8x12 |
| 107ST-125-M-RH/LH | 21150 | <a href="#">21250</a> | 1.250       | Unlimited*** | .480 | 2.125 | 6.000 | 4.750 | 1.250 | 1.250 | .190 | 1.250 | 2.500 | 1.250 | MDL**              | KPS-31-125-C  | <a href="#">28950</a> | M4-.7x4   | M5-.8x12 |

| Metric Description | UPC # |                       | CH & S mm | Dia. Range   | E     | H     | L      | L1     | L2    | L3    | P    | T     | T1    | T2    | Knurl Wheel Series | Knurl Pin Set |                       | Set Screw |          |
|--------------------|-------|-----------------------|-----------|--------------|-------|-------|--------|--------|-------|-------|------|-------|-------|-------|--------------------|---------------|-----------------------|-----------|----------|
|                    | R.H.  | L.H.                  |           |              |       |       |        |        |       |       |      |       |       |       |                    | Desc.         | UPC #                 | No. 1     | No. 2    |
| 107ST-12-R-RH/LH   | 21105 | <a href="#">21205</a> | 12        | Unlimited*** | 9.53  | 34.93 | 98.43  | 76.20  | 31.75 | 22.23 | 3.18 | 12.70 | 38.10 | 25.40 | RDL*               | KPS-25-100-C  | <a href="#">28930</a> | M4-.7x4   | M5-.8x8  |
| 107ST-162-R-RH/LH  | 21115 | <a href="#">21215</a> | 16        | Unlimited*** | 9.53  | 38.10 | 98.43  | 76.20  | 31.75 | 22.23 | 3.18 | 15.88 | 41.28 | 25.40 | RDL*               | KPS-25-100-C  | <a href="#">28930</a> | M4-.7x4   | M5-.8x8  |
| 107ST-20-M-RH/LH   | 21125 | <a href="#">21225</a> | 20        | Unlimited*** | 12.19 | 41.28 | 114.30 | 82.55  | 31.75 | 31.75 | 4.83 | 19.05 | 50.80 | 31.75 | MDL**              | KPS-31-125-C  | <a href="#">28950</a> | M4-.7x4   | M5-.8x12 |
| 107ST-25-M-RH/LH   | 21135 | <a href="#">21235</a> | 25        | Unlimited*** | 12.19 | 47.63 | 139.70 | 107.95 | 31.75 | 31.75 | 4.83 | 25.40 | 57.15 | 31.75 | MDL**              | KPS-31-125-C  | <a href="#">28950</a> | M4-.7x4   | M5-.8x12 |
| 107ST-32-M-RH/LH   | 21145 | <a href="#">21245</a> | 32        | Unlimited*** | 12.19 | 53.98 | 152.40 | 120.65 | 31.75 | 31.75 | 4.83 | 31.75 | 63.50 | 31.75 | MDL**              | KPS-31-125-C  | <a href="#">28950</a> | M4-.7x4   | M5-.8x12 |

Supplied with one (1) full faced diagonal left high speed TiN coated knurl wheel, \* 30 TPI (.8mm), \*\* 25 TPI (1.0mm)

\*\*\* Warning: May cause deflection on small part diameters, and too much pressure on large diameters

## 107ST - Straight Cutting Shoulder Knurling Tool With A Square Shank For CNC



- Knurl cutting action exerts minimum stress on the machine, and is faster than knurl forming action
- Single diagonal SW2 or SW4 series knurl wheel for a straight pattern
- For knurling closer to a shoulder
- Knurl wheel is mounted on a thrust washer to ensure a smooth and even rotation of the knurl
- Right or left hand shank
- Preset center height for CNC

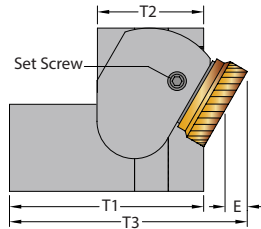

## Resulting Knurl Pattern

Straight pattern with diagonal Left Hand wheel



Left

## Recommended Use:

For best results, use sharp (full faced) knurl wheel. In-feed the knurl 1/8" on end of the part until the correct pattern is generated, then end-feed.

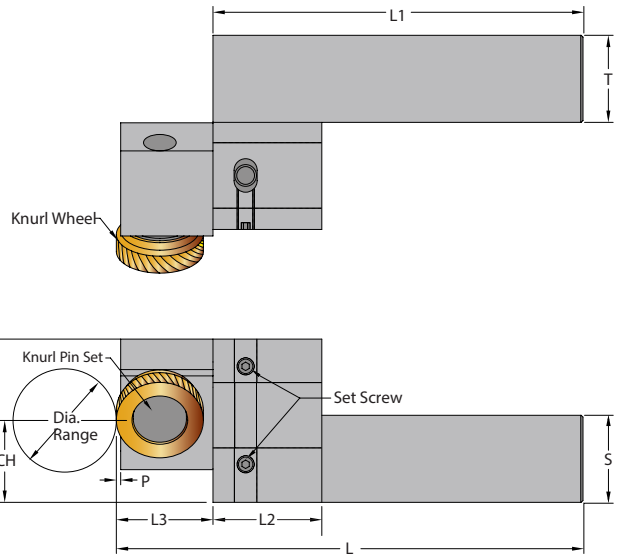

| Inch Description   | UPC # |                       | CH & S inch | Dia. Range   | E     | H     | L     | L1    | L2    | L3    | P     | T     | T1    | T2    | T3    | Knurl Wheel Series | Knurl Pin Set |                       |           |
|--------------------|-------|-----------------------|-------------|--------------|-------|-------|-------|-------|-------|-------|-------|-------|-------|-------|-------|--------------------|---------------|-----------------------|-----------|
|                    | R.H.  | L.H.                  |             |              |       |       |       |       |       |       |       |       |       |       |       |                    | Description   | UPC #                 | Set Screw |
| 107ST-50-2-RH/LH   | 21111 | 21211                 | 0.500       | Unlimited*** | 0.125 | 1.375 | 3.875 | 3.000 | 1.250 | 0.875 | 0.050 | 0.500 | 1.500 | 1.000 | 1.750 | SW2L*              | SW2.0P-1S     | <a href="#">29050</a> | M3-.5x4   |
| 107ST-162-2-RH/LH  | 21116 | 21216                 | 0.625       | Unlimited*** | 0.125 | 1.500 | 3.875 | 3.000 | 1.250 | 0.875 | 0.050 | 0.625 | 1.625 | 1.000 | 1.875 | SW2L*              | SW2.0P-1S     | <a href="#">29050</a> | M3-.5x4   |
| 107ST-75-4-RH/LH   | 21131 | <a href="#">21231</a> | 0.750       | Unlimited*** | 0.250 | 1.625 | 4.500 | 3.250 | 1.250 | 1.250 | 0.050 | 0.750 | 2.000 | 1.250 | 2.500 | SW4L**             | SW4.0P-1S     | <a href="#">29080</a> | M5-.8x5   |
| 107ST-100-4-RH/LH  | 21141 | <a href="#">21241</a> | 1.000       | Unlimited*** | 0.250 | 1.875 | 5.500 | 4.250 | 1.250 | 1.250 | 0.050 | 1.000 | 2.250 | 1.250 | 2.750 | SW4L**             | SW4.0P-1S     | <a href="#">29080</a> | M5-.8x5   |
| 107ST-125-4-RH/LH  | 21151 | <a href="#">21251</a> | 1.250       | Unlimited*** | 0.250 | 2.125 | 6.000 | 4.750 | 1.250 | 1.250 | 0.050 | 1.250 | 2.500 | 1.250 | 3.000 | SW4L**             | SW4.0P-1S     | <a href="#">29080</a> | M5-.8x5   |
| Metric Description | UPC # |                       | CH & S mm   | Dia. Range   | E     | H     | L     | L1    | L2    | L3    | P     | T     | T1    | T2    | T3    | Knurl Wheel Series | Knurl Pin Set |                       |           |
|                    | R.H.  | L.H.                  |             |              |       |       |       |       |       |       |       |       |       |       |       |                    | Description   | UPC #                 | Set Screw |
| 107ST-12-2-R/L     | 21106 | <a href="#">21206</a> | 12          | Unlimited*** | 3.2   | 34.9  | 98.4  | 76.2  | 31.8  | 22.2  | 1.3   | 12.7  | 38.1  | 25.4  | 44.5  | SW2L*              | SW2.0P-1S     | <a href="#">29050</a> | M3-.5x4   |
| 107ST-162-2-R/L    | 21116 | 21216                 | 16          | Unlimited*** | 3.2   | 38.1  | 98.4  | 76.2  | 31.8  | 22.2  | 1.3   | 15.9  | 41.3  | 25.4  | 47.6  | SW2L*              | SW2.0P-1S     | <a href="#">29050</a> | M3-.5x4   |
| 107ST-20-4-R/L     | 21126 | <a href="#">21226</a> | 20          | Unlimited*** | 6.4   | 41.3  | 114.3 | 82.6  | 31.8  | 31.8  | 1.3   | 19.1  | 50.8  | 31.8  | 63.5  | SW4L**             | SW4.0P-1S     | <a href="#">29080</a> | M5-.8x5   |
| 107ST-25-4-R/L     | 21136 | <a href="#">21236</a> | 25          | Unlimited*** | 6.4   | 47.6  | 139.7 | 108.0 | 31.8  | 31.8  | 1.3   | 25.4  | 57.2  | 31.8  | 69.9  | SW4L**             | SW4.0P-1S     | <a href="#">29080</a> | M5-.8x5   |
| 107ST-32-4-R/L     | 21146 | <a href="#">21246</a> | 32          | Unlimited*** | 6.4   | 54.0  | 152.4 | 120.7 | 31.8  | 31.8  | 1.3   | 31.8  | 63.5  | 31.8  | 76.2  | SW4L**             | SW4.0P-1S     | <a href="#">29080</a> | M5-.8x5   |

Supplied with one (1) full faced diagonal left high speed TiN coated knurl wheel, \* 30 TPI (.8mm), \*\* 25 TPI (1.0mm)

\*\*\* Warning: May cause deflection on small part diameters, and too much pressure on large diameters

# Face Forming Knurling Tool

## FACEKT - Face Forming Knurling Tool

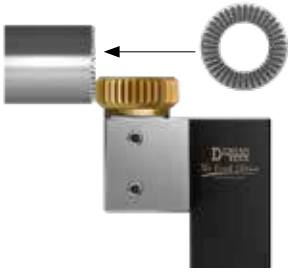

- Precision square shank with preset center height
- Single knurl wheel for straight or diamond pattern
- Knurl wheel is mounted on a thrust washer to ensure a smooth and even rotation of the knurl
- Specifically designed to knurl small width face knurl patterns, even up to a shoulder
- Head can be reversed for right or left hand operation

## Resulting Knurl Pattern

Straight pattern with straight wheel



Straight

Male 60° diamond pattern with female wheel



Female

## Recommended Use:

For best results, use beveled knurl wheels. In-feed (plunge) the knurling tool on to the blank face until the correct pattern is generated.

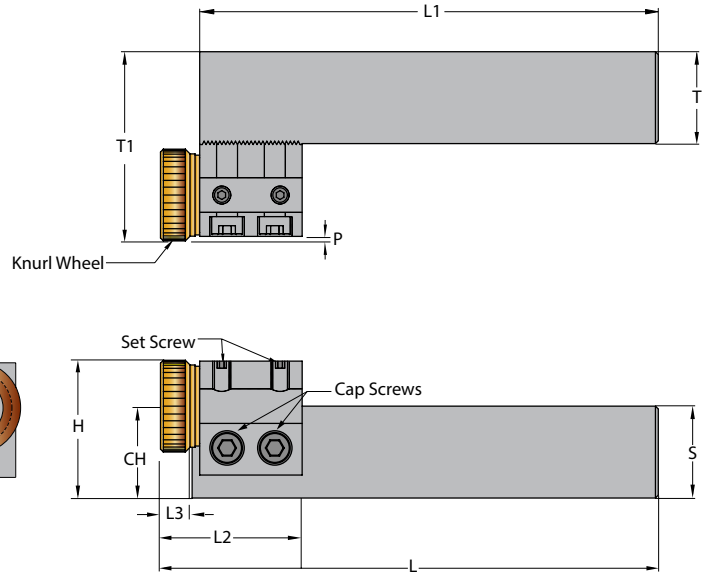
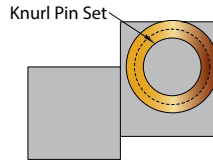
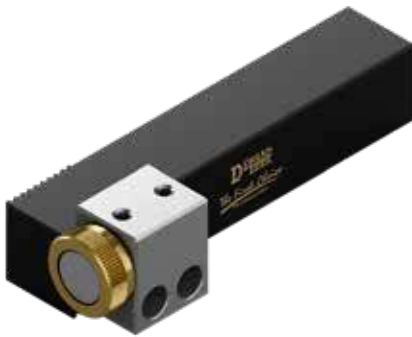

| Inch<br>Description | UPC #                 | CH & S<br>inch | Dia. Range   | H     | L     | L1    | L2    | L3    | P     | T     | T1    | Knurl<br>Wheel<br>Series | Knurl Pin Set |                       | Set<br>Screw | Cap<br>Screw |
|---------------------|-----------------------|----------------|--------------|-------|-------|-------|-------|-------|-------|-------|-------|--------------------------|---------------|-----------------------|--------------|--------------|
|                     |                       |                |              |       |       |       |       |       |       |       |       |                          | Description   | UPC #                 |              |              |
| FACEKT-75-2         | <a href="#">21620</a> | 0.750          | Unlimited*** | 1.000 | 4.375 | 4.100 | 1.375 | 0.265 | 0.050 | 0.750 | 1.530 | SW2 *                    | SW2.0P-1S     | <a href="#">29050</a> | M3-.5x3      | M5-.8x25     |
| FACEKT-100-2        | <a href="#">21630</a> | 1.000          | Unlimited*** | 1.250 | 5.375 | 5.100 | 1.375 | 0.265 | 0.050 | 1.000 | 1.780 | SW2 *                    | SW2.0P-1S     | <a href="#">29050</a> | M3-.5x3      | M5-.8x25     |
| FACEKT-75-4         | <a href="#">21640</a> | 0.750          | Unlimited*** | 1.250 | 4.500 | 4.100 | 1.500 | 0.405 | 0.050 | 0.750 | 1.780 | SW4 **                   | SW4.0P-1S     | <a href="#">29080</a> | M5-.8x8      | M5-.8x25     |
| FACEKT-100-4        | <a href="#">21650</a> | 1.000          | Unlimited*** | 1.500 | 5.500 | 5.100 | 1.500 | 0.405 | 0.050 | 1.000 | 2.000 | SW4 **                   | SW4.0P-1S     | <a href="#">29080</a> | M5-.8x8      | M5-.8x25     |

| Metric<br>Description | UPC #                 | CH & S<br>mm | Dia. Range   | H    | L     | L1    | L2   | L3   | P   | T    | T1   | Knurl<br>Wheel<br>Series | Knurl Pin Set |                       | Set<br>Screw | Cap<br>Screw |
|-----------------------|-----------------------|--------------|--------------|------|-------|-------|------|------|-----|------|------|--------------------------|---------------|-----------------------|--------------|--------------|
|                       |                       |              |              |      |       |       |      |      |     |      |      |                          | Description   | UPC #                 |              |              |
| FACEKT-20-2           | <a href="#">21615</a> | 20           | Unlimited*** | 25.4 | 111.1 | 104.1 | 34.9 | 6.7  | 1.3 | 19.1 | 38.9 | SW2 *                    | SW2.0P-1S     | <a href="#">29050</a> | M3-.5x3      | M5-.8x25     |
| FACEKT-25-2           | <a href="#">21625</a> | 25           | Unlimited*** | 31.8 | 136.5 | 129.5 | 34.9 | 6.7  | 1.3 | 25.4 | 45.2 | SW2 *                    | SW2.0P-1S     | <a href="#">29050</a> | M3-.5x3      | M5-.8x25     |
| FACEKT-20-4           | <a href="#">21635</a> | 20           | Unlimited*** | 31.8 | 114.3 | 104.1 | 38.1 | 10.3 | 1.3 | 19.1 | 45.2 | SW4 **                   | SW4.0P-1S     | <a href="#">29080</a> | M5-.8x8      | M5-.8x25     |
| FACEKT-25-4           | <a href="#">21645</a> | 25           | Unlimited*** | 38.1 | 139.7 | 129.5 | 38.1 | 10.3 | 1.3 | 25.4 | 50.8 | SW4 **                   | SW4.0P-1S     | <a href="#">29080</a> | M5-.8x8      | M5-.8x25     |

Supplied with one (1) beveled straight high speed TiN coated knurl wheel, \* 30 TPI (.8mm), \*\* 25 TPI (1.0mm)  
 \*\*\* Limited band width from knurl wheel

## 3SHKT - Three Swivel Head Forming Knurling Tool



- Precision square shank with preset center height
- Three sets of twin knurl wheels for straight or diamond pattern
- Knurl wheels are mounted between thrust washers to ensure a smooth and even rotation of the knurls
- Three pairs of knurl wheels to change pitch or pattern quickly
- Head can be reversed for right or left hand operation

## Resulting Knurl Pattern

Straight pattern with straight wheels      Male 60° diamond pattern with diagonal wheels



## Recommended Use:

For best results, use beveled knurl wheels. In-feed the knurling tool into the blank until the correct pattern is generated, then end-feed.

## Self-Center Knurling 3 Wheel Set

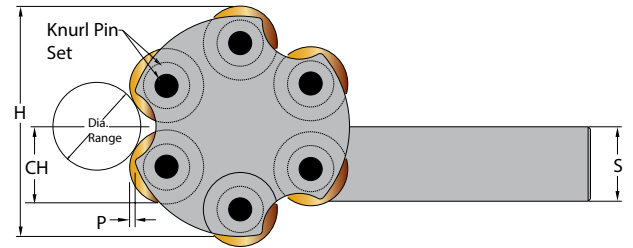
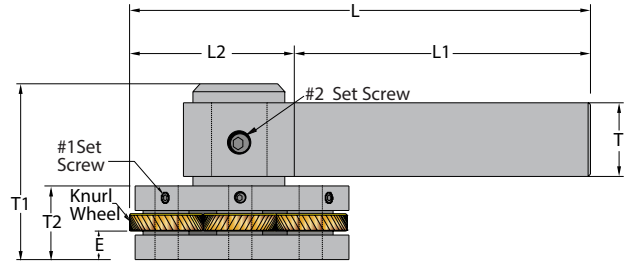
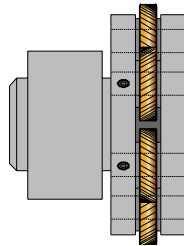

| Inch Description   | UPC #                 | CH & S inch | Dia. Range    | E     | H     | L     | L1    | L2    | P     | T     | T1    | T2    | Knurl Wheel Series | Knurl Pin Set |                       | Set Screw |           | Spring & Ball Set | UPC #                 |
|--------------------|-----------------------|-------------|---------------|-------|-------|-------|-------|-------|-------|-------|-------|-------|--------------------|---------------|-----------------------|-----------|-----------|-------------------|-----------------------|
|                    |                       |             |               |       |       |       |       |       |       |       |       |       |                    | Description   | UPC #                 | No. 1     | No. 2     |                   |                       |
| 3SHKT-50-D         | <a href="#">21510</a> | 0.500       | 1/4" & up***  | 0.195 | 1.660 | 4.125 | 2.750 | 1.375 | 0.035 | 0.750 | 1.690 | 0.690 | D *                | KPS-18-62     | <a href="#">28810</a> | M3-.5x3   | M6-1.00x6 | STBL-18           | <a href="#">28525</a> |
| 3SHKT-162-D        | <a href="#">21515</a> | 0.625       |               | 0.195 | 1.660 | 4.125 | 2.750 | 1.375 | 0.035 | 0.750 | 1.690 | 0.690 | D *                | KPS-18-62     | <a href="#">28810</a> | M3-.5x3   | M6-1.00x6 | STBL-18           | <a href="#">28525</a> |
| 3SHKT-75-M         | <a href="#">21530</a> | 0.750       | 5/16" & up*** | 0.380 | 3.000 | 5.500 | 3.250 | 2.250 | 0.075 | 1.000 | 2.375 | 1.125 | M **               | KPS-31-100    | <a href="#">28845</a> | M4-.7x4   | M8-1.25x8 | STBL-25           | <a href="#">28530</a> |
| 3SHKT-100-M        | <a href="#">21540</a> | 1.000       |               | 0.380 | 3.000 | 6.250 | 4.000 | 2.250 | 0.075 | 1.000 | 2.375 | 1.125 | M **               | KPS-31-100    | <a href="#">28845</a> | M4-.7x4   | M8-1.25x8 | STBL-25           | <a href="#">28530</a> |
| 3SHKT-125-M        | <a href="#">21550</a> | 1.250       |               | 0.380 | 3.000 | 7.375 | 5.000 | 2.375 | 0.075 | 1.000 | 2.375 | 1.125 | M **               | KPS-31-100    | <a href="#">28845</a> | M4-.7x4   | M8-1.25x8 | STBL-25           | <a href="#">28530</a> |
| Metric Description | UPC #                 | CH & S mm   | Dia. Range    | E     | H     | L     | L1    | L2    | P     | T     | T1    | T2    | Knurl Wheel Series | Description   | UPC #                 | No. 1     | No. 2     | Spring & Ball Set | UPC #                 |
| 3SHKT-12-D         | <a href="#">21505</a> | 12          | 6.4mm & up*** | 5.0   | 42.2  | 104.8 | 69.9  | 34.9  | 0.9   | 19.1  | 42.9  | 17.5  | D *                | KPS-18-62     | <a href="#">28810</a> | M3-.5x3   | M6-1.00x6 | STBL-18           | <a href="#">28525</a> |
| 3SHKT-162-D        | <a href="#">21515</a> | 16          |               | 5.0   | 42.2  | 104.8 | 69.9  | 34.9  | 0.9   | 19.1  | 42.9  | 17.5  | D *                | KPS-18-62     | <a href="#">28810</a> | M3-.5x3   | M6-1.00x6 | STBL-18           | <a href="#">28525</a> |
| 3SHKT-20-M         | <a href="#">21525</a> | 20          | 8mm & up***   | 9.7   | 76.2  | 139.7 | 82.6  | 57.2  | 1.9   | 25.4  | 60.3  | 28.6  | M **               | KPS-31-100    | <a href="#">28845</a> | M4-.7x4   | M8-1.25x8 | STBL-25           | <a href="#">28530</a> |
| 3SHKT-25-M         | <a href="#">21535</a> | 25          |               | 9.7   | 76.2  | 158.8 | 101.6 | 57.2  | 1.9   | 25.4  | 60.3  | 28.6  | M **               | KPS-31-100    | <a href="#">28845</a> | M4-.7x4   | M8-1.25x8 | STBL-25           | <a href="#">28530</a> |
| 3SHKT-32-M         | <a href="#">21545</a> | 32          |               | 9.7   | 76.2  | 187.3 | 127.0 | 60.3  | 1.9   | 25.4  | 60.3  | 28.6  | M **               | KPS-31-100    | <a href="#">28845</a> | M4-.7x4   | M8-1.25x8 | STBL-25           | <a href="#">28530</a> |

\* Supplied with three (3) sets of beveled diagonal right and diagonal left high speed TiN coated knurl wheels, 20 TPI (1.2mm), 30 TPI (0.8mm), 40 TPI (0.6mm)

\*\* Supplied with three (3) sets of beveled diagonal right and diagonal left high speed TiN coated knurl wheels, 16 TPI (1.6mm), 25 TPI (1.0mm), 35 TPI (0.7mm)

\*\*\* Warning: May cause deflection on small part diameters, and too much pressure on large diameters

# Double Wheel Self-Centering Forming Knurling Tool

## SCKN - Self-Centering Knurling Tool HD SCKN Heavy Duty Self-Centering Knurling Tool



- Specifically designed for CNC lathes
- Precision square shank with preset center height
- Twin knurl wheels for straight or diamond pattern
- Knurl wheels are mounted between thrust washers to ensure smooth & even rotation of knurls
- Self-centering knurling head for a precise alignment
- Head is reversible for right or left hand knurl application

## Resulting Knurl Pattern

Straight pattern with straight wheels      Male 60° diamond pattern with diagonal wheels



Straight      Left      Right

## Recommended Use:

For best results, use beveled knurl wheels. In-feed the knurling tool into the blank until the right pattern is generated, then end-feed.

## Self-Center Knurling Twin Wheel Set

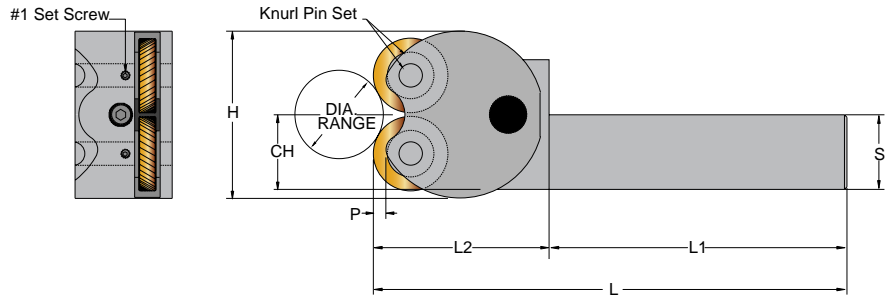
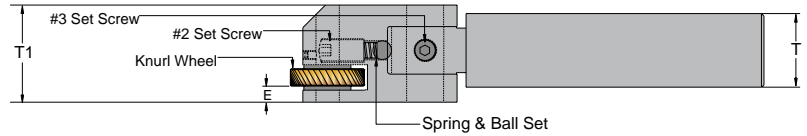

| Inch             |                       |             | CH & S<br>inch | Dia. Range | E     | H     | L     | L1    | L2    | P     | T     | T1   | Knurl<br>Wheel<br>Series | Knurl Pin Set         |         |           | Set Screw |         |                       | Spring<br>& Ball<br>Set | UPC # |
|------------------|-----------------------|-------------|----------------|------------|-------|-------|-------|-------|-------|-------|-------|------|--------------------------|-----------------------|---------|-----------|-----------|---------|-----------------------|-------------------------|-------|
| Description      | UPC #                 | Description |                |            |       |       |       |       |       |       |       |      |                          | UPC #                 | No. 1   | No. 2     | No. 3     |         |                       |                         |       |
| SCKN-38-DW-D     | <a href="#">22151</a> | 0.375       | 1/4" & up***   | .115       | 1.375 | 3.875 | 2.500 | 1.375 | 0.030 | 0.500 | 0.750 | D *  | KPS-18-50                | <a href="#">28805</a> | M3-.5x3 | M6-1.0x6  | M5-.8x5   | STBL-18 | <a href="#">28525</a> |                         |       |
| SCKN-50-DW-D     | 22111                 | 0.500       |                | .115       | 1.375 | 4.125 | 2.750 | 1.375 | 0.030 | 0.625 | 0.750 | D *  | KPS-18-50                | <a href="#">28805</a> | M3-.5x3 | M6-1.0x6  | M5-.8x5   | STBL-18 | <a href="#">28525</a> |                         |       |
| SCKN-162-DW-D    | 22115                 | 0.625       |                | .115       | 1.375 | 4.375 | 3.000 | 1.375 | 0.030 | 0.625 | 0.750 | D *  | KPS-18-50                | <a href="#">28805</a> | M3-.5x3 | M6-1.0x6  | M5-.8x5   | STBL-18 | <a href="#">28525</a> |                         |       |
| SCKN-75-DW-M     | <a href="#">22121</a> | 0.750       | 5/16" & up***  | .211       | 2.250 | 5.625 | 3.250 | 2.375 | 0.170 | 0.750 | 1.312 | M ** | KPS-31-100               | <a href="#">28845</a> | M3-.5x3 | M8-1.25x8 | M6-1.0x12 | STBL-25 | <a href="#">28530</a> |                         |       |
| SCKN-100-DW-M    | <a href="#">22131</a> | 1.000       |                | .211       | 2.250 | 6.375 | 4.000 | 2.375 | 0.170 | 1.000 | 1.312 | M ** | KPS-31-100               | <a href="#">28845</a> | M3-.5x3 | M8-1.25x8 | M6-1.0x12 | STBL-25 | <a href="#">28530</a> |                         |       |
| SCKN-125-DW-M    | <a href="#">22141</a> | 1.250       |                | .211       | 2.250 | 7.375 | 5.000 | 2.375 | 0.170 | 1.250 | 1.312 | M ** | KPS-31-100               | <a href="#">28845</a> | M3-.5x3 | M8-1.25x8 | M6-1.0x12 | STBL-25 | <a href="#">28530</a> |                         |       |
| HD SCKN-75-DW-O  | <a href="#">22410</a> | 0.750       | 3/4" & up***   | .437       | 2.750 | 5.875 | 3.250 | 2.625 | 0.200 | 0.750 | 1.250 | O ** | KPS-31-125-C             | <a href="#">28950</a> | M4-.7x4 | M8-1.25x8 | M6-1.0x12 | STBL-25 | <a href="#">28530</a> |                         |       |
| HD SCKN-100-DW-O | <a href="#">22420</a> | 1.000       |                | .437       | 2.750 | 6.625 | 4.000 | 2.625 | 0.200 | 1.000 | 1.250 | O ** | KPS-31-125-C             | <a href="#">28950</a> | M4-.7x4 | M8-1.25x8 | M6-1.0x12 | STBL-25 | <a href="#">28530</a> |                         |       |
| HD SCKN-100-DW-P | <a href="#">22430</a> | 1.000       | 1.0" & up ***  | .375       | 3.250 | 6.875 | 4.000 | 2.875 | 0.125 | 1.000 | 1.250 | P ** | KPS-50-125-C             | <a href="#">28955</a> | M4-.7x6 | M8-1.25x8 | M6-1.0x12 | STBL-25 | <a href="#">28530</a> |                         |       |
| HD SCKN-125-DW-P | <a href="#">22440</a> | 1.250       |                | .375       | 3.250 | 7.875 | 5.000 | 2.875 | 0.125 | 1.250 | 1.250 | P ** | KPS-50-125-C             | <a href="#">28955</a> | M4-.7x6 | M8-1.25x8 | M6-1.0x12 | STBL-25 | <a href="#">28530</a> |                         |       |

| Metric          |                       |             | CH & S<br>mm  | Dia. Range | E    | H     | L     | L1   | L2  | P    | T    | T1   | Knurl<br>Wheel<br>Series | Knurl Pin Set         |         | Set Screw |           |         | Spring<br>& Ball<br>Set | UPC # |
|-----------------|-----------------------|-------------|---------------|------------|------|-------|-------|------|-----|------|------|------|--------------------------|-----------------------|---------|-----------|-----------|---------|-------------------------|-------|
| Description     | UPC #                 | Description |               |            |      |       |       |      |     |      |      |      |                          | UPC #                 | No. 1   | No. 2     | No. 3     |         |                         |       |
| SCKN-10-DW-D    | <a href="#">22161</a> | 10          | 6.4mm & up*** | 2.9        | 34.9 | 98.4  | 63.5  | 34.9 | 0.8 | 12.7 | 19.1 | D *  | KPS-18-50                | <a href="#">28805</a> | M3-.5x3 | M6-1.0x6  | M5-.8x5   | STBL-18 | <a href="#">28525</a>   |       |
| SCKN-12-DW-D    | <a href="#">22106</a> | 12          |               | 2.9        | 34.9 | 104.8 | 69.9  | 34.9 | 0.8 | 15.9 | 19.1 | D *  | KPS-18-50                | <a href="#">28805</a> | M3-.5x3 | M6-1.0x6  | M5-.8x5   | STBL-18 | <a href="#">28525</a>   |       |
| SCKN-162-DW-D   | 22115                 | 16          |               | 2.9        | 34.9 | 111.1 | 76.2  | 34.9 | 0.8 | 15.9 | 19.1 | D *  | KPS-18-50                | <a href="#">28805</a> | M3-.5x3 | M6-1.0x6  | M5-.8x5   | STBL-18 | <a href="#">28525</a>   |       |
| SCKN-20-DW-M    | 22116                 | 20          | 8mm & up***   | 5.4        | 57.2 | 142.9 | 82.6  | 60.3 | 4.3 | 19.1 | 33.3 | M ** | KPS-31-100               | <a href="#">28845</a> | M3-.5x3 | M8-1.25x8 | M6-1.0x12 | STBL-25 | <a href="#">28530</a>   |       |
| SCKN-25-DW-M    | <a href="#">22126</a> | 25          |               | 5.4        | 57.2 | 161.9 | 101.6 | 60.3 | 4.3 | 25.4 | 33.3 | M ** | KPS-31-100               | <a href="#">28845</a> | M3-.5x3 | M8-1.25x8 | M6-1.0x12 | STBL-25 | <a href="#">28530</a>   |       |
| SCKN-32-DW-M    | <a href="#">22136</a> | 32          |               | 5.4        | 57.2 | 187.3 | 127.0 | 60.3 | 4.3 | 31.8 | 33.3 | M ** | KPS-31-100               | <a href="#">28845</a> | M3-.5x3 | M8-1.25x8 | M6-1.0x12 | STBL-25 | <a href="#">28530</a>   |       |
| HD SCKN-20-DW-O | <a href="#">22405</a> | 20          | 19mm & up***  | 11.1       | 69.9 | 149.2 | 82.6  | 66.7 | 5.1 | 19.1 | 31.8 | O ** | KPS-31-125-C             | <a href="#">28950</a> | M4-.7x4 | M8-1.25x8 | M6-1.0x12 | STBL-25 | <a href="#">28530</a>   |       |
| HD SCKN-25-DW-O | <a href="#">22415</a> | 25          |               | 11.1       | 69.9 | 168.3 | 101.6 | 66.7 | 5.1 | 25.4 | 31.8 | O ** | KPS-31-125-C             | <a href="#">28950</a> | M4-.7x4 | M8-1.25x8 | M6-1.0x12 | STBL-25 | <a href="#">28530</a>   |       |
| HD SCKN-25-DW-P | <a href="#">22425</a> | 25          | 25mm & up***  | 9.5        | 82.6 | 174.6 | 101.6 | 73.0 | 3.2 | 25.4 | 31.8 | P ** | KPS-50-125-C             | <a href="#">28955</a> | M4-.7x6 | M8-1.25x8 | M6-1.0x12 | STBL-25 | <a href="#">28530</a>   |       |
| HD SCKN-32-DW-P | <a href="#">22435</a> | 32          |               | 9.5        | 82.6 | 200.0 | 127.0 | 73.0 | 3.2 | 31.8 | 31.8 | P ** | KPS-50-125-C             | <a href="#">28955</a> | M4-.7x6 | M8-1.25x8 | M6-1.0x12 | STBL-25 | <a href="#">28530</a>   |       |

Supplied with one (1) set of beveled diagonal high speed knurl wheels, \*30 TPI (0.8mm), \*\*25 TPI (1.0mm)  
 \*\*\* Warning: May cause deflections on small part diameters, and too much pressure on large diameters

## SSCK - Shoulder Self-Centering Knurling Tool

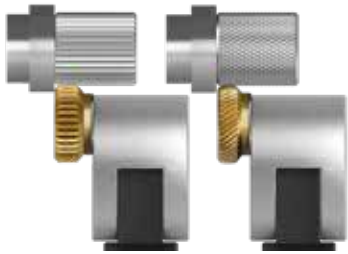

- Specifically designed for CNC lathes
- Designed to knurl against a square shoulder
- Precision square shank with preset center height
- Twin knurl wheels for straight or diamond pattern
- Knurl wheels are mounted on a thrust washer to ensure a smooth and even rotation of the knurl
- Self-centering knurling head for a precise alignment
- Head is reversible for right or left hand knurl application

## Resulting Knurl Pattern

Straight pattern with straight wheels



Straight

Male 60° diamond pattern with diagonal wheels



Left

Right

## Recommended Use:

For best results, use beveled knurl wheels. In-feed the knurling tool into the blank until the right pattern is generated, then end-feed.

## Self-Center Knurling Twin Wheel Set

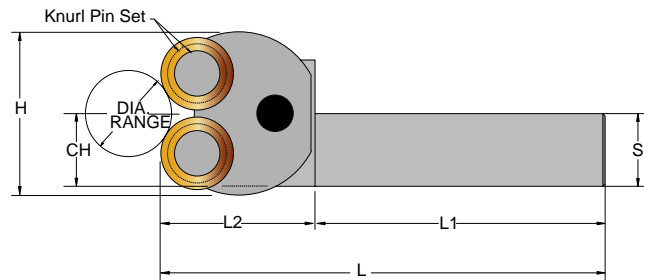
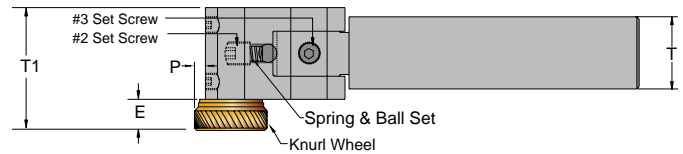
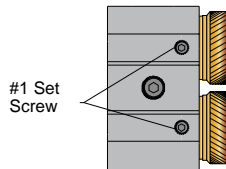

| Inch          |                       | CH & S<br>inch | Dia.<br>Range |      |       |       |       |       |       |       |       | Knurl<br>Wheel<br>Series | Knurl Pin Set |                       | Set Screw |           |           | Spring<br>& Ball<br>Set | UPC #                 |
|---------------|-----------------------|----------------|---------------|------|-------|-------|-------|-------|-------|-------|-------|--------------------------|---------------|-----------------------|-----------|-----------|-----------|-------------------------|-----------------------|
| Description   | UPC #                 |                |               | E    | H     | L     | L1    | L2    | P     | T     | T1    |                          | Description   | UPC #                 | No. 1     | No. 2     | No. 3     |                         |                       |
| SSCK-38-DW-2  | <a href="#">22210</a> | 0.375          | 1/4" & up***  | .265 | 1.375 | 3.875 | 2.500 | 1.375 | 0.050 | 0.500 | 1.015 | SW2 *                    | SW2.0P-2S     | <a href="#">29055</a> | M3-.5x3   | M6-1.0x6  | M5-.8x5   | STBL-18                 | <a href="#">28525</a> |
| SSCK-50-DW-2  | <a href="#">22220</a> | 0.500          |               | .265 | 1.375 | 4.125 | 2.750 | 1.375 | 0.050 | 0.625 | 1.015 | SW2 *                    | SW2.0P-2S     | <a href="#">29055</a> | M3-.5x3   | M6-1.0x6  | M5-.8x5   | STBL-18                 | <a href="#">28525</a> |
| SSCK-162-DW-2 | <a href="#">22218</a> | 0.625          |               | .265 | 1.375 | 4.375 | 3.000 | 1.375 | 0.050 | 0.625 | 1.015 | SW2 *                    | SW2.0P-2S     | <a href="#">29055</a> | M3-.5x3   | M6-1.0x6  | M5-.8x5   | STBL-18                 | <a href="#">28525</a> |
| SSCK-75-DW-4  | <a href="#">22240</a> | 0.750          | 5/16" & up*** | .410 | 2.250 | 5.375 | 3.250 | 2.125 | 0.050 | 0.750 | 1.660 | SW4 **                   | SW4.0P-2S     | <a href="#">29085</a> | M5-.8x5   | M8-1.25x8 | M6-1.0x12 | STBL-25                 | <a href="#">28530</a> |
| SSCK-100-DW-4 | <a href="#">22250</a> | 1.000          |               | .410 | 2.250 | 6.125 | 4.000 | 2.125 | 0.050 | 1.000 | 1.660 | SW4 **                   | SW4.0P-2S     | <a href="#">29085</a> | M5-.8x5   | M8-1.25x8 | M6-1.0x12 | STBL-25                 | <a href="#">28530</a> |
| SSCK-125-DW-4 | <a href="#">22260</a> | 1.250          |               | .410 | 2.250 | 7.125 | 5.000 | 2.125 | 0.050 | 1.250 | 1.660 | SW4 **                   | SW4.0P-2S     | <a href="#">29085</a> | M5-.8x5   | M8-1.25x8 | M6-1.0x12 | STBL-25                 | <a href="#">28530</a> |

| Metric        |                       | CH & S<br>mm | Dia.<br>Range |      |      |       |       |      |     |      |      | Knurl<br>Wheel<br>Series | Knurl Pin Set |                       | Set Screw |           |           | Spring<br>& Ball<br>Set | UPC #                 |
|---------------|-----------------------|--------------|---------------|------|------|-------|-------|------|-----|------|------|--------------------------|---------------|-----------------------|-----------|-----------|-----------|-------------------------|-----------------------|
| Description   | UPC #                 |              |               | E    | H    | L     | L1    | L2   | P   | T    | T1   |                          | Description   | UPC #                 | No. 1     | No. 2     | No. 3     |                         |                       |
| SSCK-10-DW-2  | <a href="#">22205</a> | 10           | 6.4mm & up*** | 6.7  | 34.9 | 98.4  | 63.5  | 34.9 | 1.3 | 12.7 | 22.6 | SW2 *                    | SW2.0P-2S     | <a href="#">29055</a> | M3-.5x3   | M6-1.0x6  | M5-.8x5   | STBL-18                 | <a href="#">28525</a> |
| SSCK-12-DW-2  | <a href="#">22215</a> | 12           |               | 6.7  | 34.9 | 104.8 | 69.9  | 34.9 | 1.3 | 15.9 | 22.6 | SW2 *                    | SW2.0P-2S     | <a href="#">29055</a> | M3-.5x3   | M6-1.0x6  | M5-.8x5   | STBL-18                 | <a href="#">28525</a> |
| SSCK-162-DW-2 | <a href="#">22218</a> | 16           |               | 6.7  | 34.9 | 111.1 | 76.2  | 34.9 | 1.3 | 15.9 | 22.6 | SW2 *                    | SW2.0P-2S     | <a href="#">29055</a> | M3-.5x3   | M6-1.0x6  | M5-.8x5   | STBL-18                 | <a href="#">28525</a> |
| SSCK-20-DW-4  | <a href="#">22235</a> | 20           | 8mm & up***   | 10.4 | 57.2 | 136.5 | 82.6  | 54.0 | 1.3 | 19.1 | 42.2 | SW4 **                   | SW4.0P-2S     | <a href="#">29085</a> | M5-.8x5   | M8-1.25x8 | M6-1.0x12 | STBL-25                 | <a href="#">28530</a> |
| SSCK-25-DW-4  | <a href="#">22245</a> | 25           |               | 10.4 | 57.2 | 155.6 | 101.6 | 54.0 | 1.3 | 25.4 | 42.2 | SW4 **                   | SW4.0P-2S     | <a href="#">29085</a> | M5-.8x5   | M8-1.25x8 | M6-1.0x12 | STBL-25                 | <a href="#">28530</a> |
| SSCK-32-DW-4  | <a href="#">22255</a> | 32           |               | 10.4 | 57.2 | 181.0 | 127.0 | 54.0 | 1.3 | 31.8 | 42.2 | SW4 **                   | SW4.0P-2S     | <a href="#">29085</a> | M5-.8x5   | M8-1.25x8 | M6-1.0x12 | STBL-25                 | <a href="#">28530</a> |

Supplied with one (1) set of beveled diagonal high speed TiN coated knurl wheels, \*30 TPI (.8mm), \*\*25 TPI (1.0mm)  
 \*\*\* Warning: May cause deflection on small part diameters, and too much pressure on large diameters

# Single Wheel Fixed Forming Knurling Tool

## SWFKT - Single Wheel Fixed Forming Knurling Tool HDSWFKT - Heavy Duty Single Wheel Fixed Forming Knurling Tool



- Precision square shank with preset center height
- Single wheel knurling tool for general purposes
- Knurl wheel is mounted between thrust washers to ensure a smooth and even rotation of the knurls



### Resulting Knurl Pattern

Straight pattern with straight wheel



Straight

Male 60° diamond pattern with female wheel



Female

Female 60° diamond pattern with male wheel



Male

### Recommended Use:

For best results, use beveled knurl wheel. In-feed the knurling tool into the blank until the right pattern is generated, then end-feed for straight pattern. Do not end-feed for diamond pattern.

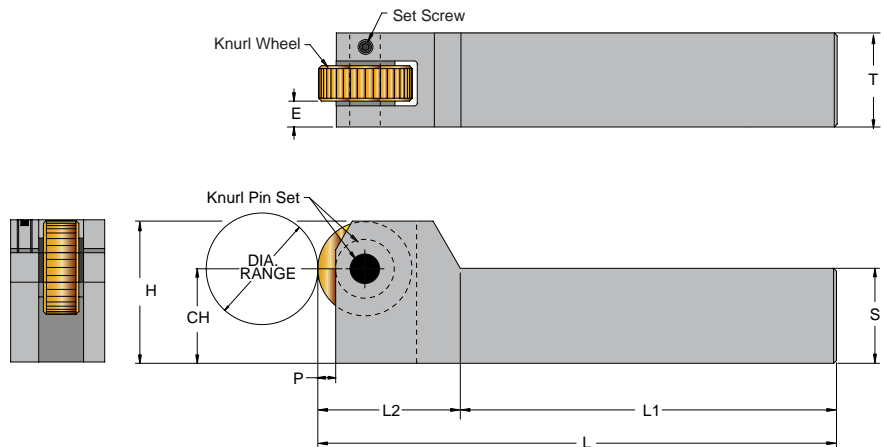

| Inch<br>Description | UPC #                 | CH & S<br>inch | Dia. Range   | E     | H     | L     | L1    | L2    | P     | T     | Knurl<br>Wheel<br>Series | Knurl Pin Set |                       | Set Screw |
|---------------------|-----------------------|----------------|--------------|-------|-------|-------|-------|-------|-------|-------|--------------------------|---------------|-----------------------|-----------|
|                     |                       |                |              |       |       |       |       |       |       |       |                          | Desc.         | UPC #                 |           |
| SWFKT-831-B         | <a href="#">21705</a> | 0.312          | Unlimited*** | 0.080 | 0.500 | 2.625 | 2.000 | 0.625 | 0.030 | 0.375 | B *                      | KPS-12-38     | <a href="#">28800</a> | M3-5x3    |
| SWFKT-38-D          | <a href="#">21720</a> | 0.375          | Unlimited*** | 0.150 | 0.625 | 3.375 | 2.500 | 0.875 | 0.060 | 0.500 | D *                      | KPS-18-50     | <a href="#">28805</a> | M3-5x3    |
| SWFKT-50-D          | <a href="#">21730</a> | 0.500          | Unlimited*** | 0.150 | 0.750 | 3.625 | 2.750 | 0.875 | 0.060 | 0.500 | D *                      | KPS-18-50     | <a href="#">28805</a> | M3-5x3    |
| SWFKT-162-D         | <a href="#">21765</a> | 0.625          | Unlimited*** | 0.150 | 0.875 | 4.000 | 3.000 | 1.000 | 0.060 | 0.625 | D *                      | KPS-18-62     | <a href="#">28810</a> | M3-5x3    |
| SWFKT-75-M          | <a href="#">21740</a> | 0.750          | Unlimited*** | 0.250 | 1.250 | 4.750 | 3.250 | 1.500 | 0.190 | 0.750 | M **                     | KPS-31-75     | <a href="#">28840</a> | M3-5x5    |
| SWFKT-100-O         | <a href="#">21750</a> | 1.000          | Unlimited*** | 0.280 | 1.500 | 5.500 | 4.000 | 1.500 | 0.190 | 1.000 | O **                     | KPS-31-100    | <a href="#">28845</a> | M4-7x8    |
| SWFKT-125-O         | <a href="#">21760</a> | 1.250          | Unlimited*** | 0.300 | 1.750 | 6.500 | 5.000 | 1.500 | 0.190 | 1.250 | O **                     | KPS-31-125    | <a href="#">28850</a> | M5-8x8    |
| HDSWFKT-75-O        | <a href="#">21810</a> | 0.750          | Unlimited*** | 0.260 | 1.250 | 4.750 | 3.250 | 1.500 | 0.190 | 1.000 | O **                     | KPS-31-100-C  | <a href="#">28945</a> | M4-7x8    |
| HDSWFKT-100-P       | <a href="#">21820</a> | 1.000          | Unlimited*** | 0.300 | 1.500 | 5.875 | 4.000 | 1.875 | 0.225 | 1.250 | P **                     | KPS-50-125-C  | <a href="#">28955</a> | M5-8x8    |
| HDSWFKT-125-P       | <a href="#">21830</a> | 1.250          | Unlimited*** | 0.300 | 1.750 | 6.750 | 5.000 | 1.750 | 0.225 | 1.250 | P **                     | KPS-50-125-C  | <a href="#">28955</a> | M5-8x8    |

| Metric<br>Description | UPC #                 | CH & S<br>mm | Dia. Range   | E   | H    | L     | L1    | L2   | P   | T    | Knurl<br>Wheel<br>Series | Knurl Pin Set |                       | Set Screw |
|-----------------------|-----------------------|--------------|--------------|-----|------|-------|-------|------|-----|------|--------------------------|---------------|-----------------------|-----------|
|                       |                       |              |              |     |      |       |       |      |     |      |                          | Desc.         | UPC #                 |           |
| SWFKT-831-B           | <a href="#">21705</a> | 8            | Unlimited*** | 2.0 | 12.7 | 66.7  | 50.8  | 15.9 | 0.8 | 9.5  | B *                      | KPS-12-38     | <a href="#">28800</a> | M3-5x3    |
| SWFKT-10-D            | <a href="#">21715</a> | 10           | Unlimited*** | 3.8 | 15.9 | 85.7  | 63.5  | 22.2 | 1.5 | 12.7 | D *                      | KPS-18-50     | <a href="#">28805</a> | M3-5x3    |
| SWFKT-12-D            | <a href="#">21725</a> | 12           | Unlimited*** | 3.8 | 19.1 | 92.1  | 69.9  | 22.2 | 1.5 | 12.7 | D *                      | KPS-18-50     | <a href="#">28805</a> | M3-5x3    |
| SWFKT-162-D           | <a href="#">21765</a> | 16           | Unlimited*** | 3.8 | 22.2 | 101.6 | 76.2  | 25.4 | 1.5 | 15.9 | D *                      | KPS-18-62     | <a href="#">28810</a> | M3-5x3    |
| SWFKT-20-M            | <a href="#">21735</a> | 20           | Unlimited*** | 6.4 | 31.8 | 120.7 | 82.6  | 38.1 | 4.8 | 19.1 | M **                     | KPS-31-75     | <a href="#">28840</a> | M3-5x5    |
| SWFKT-25-O            | <a href="#">21745</a> | 25           | Unlimited*** | 7.1 | 38.1 | 139.7 | 101.6 | 38.1 | 4.8 | 25.4 | O **                     | KPS-31-100    | <a href="#">28845</a> | M4-7x8    |
| SWFKT-32-O            | <a href="#">21755</a> | 32           | Unlimited*** | 7.6 | 44.5 | 165.1 | 127.0 | 38.1 | 4.8 | 31.8 | O **                     | KPS-31-125    | <a href="#">28850</a> | M5-8x8    |
| HDSWFKT-20-O          | <a href="#">21805</a> | 20           | Unlimited*** | 6.6 | 31.8 | 120.7 | 82.6  | 38.1 | 4.8 | 25.4 | O **                     | KPS-31-100-C  | <a href="#">28945</a> | M4-7x8    |
| HDSWFKT-25-P          | <a href="#">21815</a> | 25           | Unlimited*** | 7.6 | 38.1 | 149.2 | 101.6 | 47.6 | 5.7 | 31.8 | P **                     | KPS-50-125-C  | <a href="#">28955</a> | M5-8x8    |
| HDSWFKT-32-P          | <a href="#">21825</a> | 32           | Unlimited*** | 7.6 | 44.5 | 171.5 | 127.0 | 44.5 | 5.7 | 31.8 | P **                     | KPS-50-125-C  | <a href="#">28955</a> | M5-8x8    |

Supplied with one (1) straight high speed beveled TiN coated knurl wheel, \*30 TPI (0.8mm), \*\*25 TPI (1.0mm)

\*\*\* Warning: May cause deflection on small part diameters, and too much pressure on large diameters

## FKT - Fixed Forming Knurling Tool



- Precision square shank with preset center height
- Twin knurl wheels for straight or diamond pattern
- Knurl wheels are mounted between thrust washers to ensure a smooth and even rotation of the knurls

### Resulting Knurl Pattern

Straight pattern with straight wheels



Straight

Male 60° diamond pattern with diagonal wheels



Left

Right

### Recommended Use:

For best results, use beveled knurl wheels. In-feed the knurling tool into the blank until the right pattern is generated, then end-feed

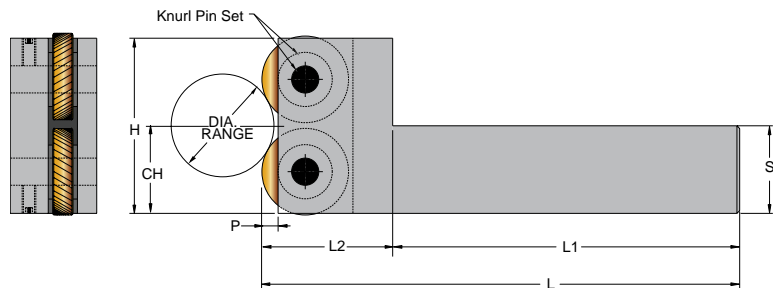

| Inch        |                       |             | Dia. Range    | E     | H     | L     | L1    | L2    | P     | T     | Knurl Wheel Series | Knurl Pin Set |                       | Set Screw |
|-------------|-----------------------|-------------|---------------|-------|-------|-------|-------|-------|-------|-------|--------------------|---------------|-----------------------|-----------|
| Description | UPC #                 | CH & S inch |               |       |       |       |       |       |       |       |                    | Description   | UPC #                 |           |
| FKT-38-D    | <a href="#">21910</a> | 0.375       | 1/4" & up***  | 0.135 | 1.000 | 3.375 | 2.500 | 0.875 | 0.060 | 0.500 | D *                | KPS-18-50     | <a href="#">28805</a> | M3-.5x3   |
| FKT-50-D    | <a href="#">21920</a> | 0.500       |               | 0.135 | 1.000 | 3.625 | 2.750 | 0.875 | 0.060 | 0.500 | D *                | KPS-18-50     | <a href="#">28805</a> | M3-.5x3   |
| FKT-162-D   | <a href="#">21955</a> | 0.625       |               | 0.135 | 1.125 | 4.000 | 3.000 | 1.000 | 0.060 | 0.625 | D *                | KPS-18-62     | <a href="#">28810</a> | M3-.5x3   |
| FKT-75-M    | <a href="#">21930</a> | 0.750       | 5/16" & up*** | 0.250 | 2.000 | 4.750 | 3.250 | 1.500 | 0.190 | 0.750 | M **               | KPS-31-75     | <a href="#">28840</a> | M4-.7x6   |
| FKT-100-M   | <a href="#">21940</a> | 1.000       |               | 0.250 | 2.000 | 5.500 | 4.000 | 1.500 | 0.190 | 1.000 | M **               | KPS-31-100    | <a href="#">28845</a> | M4-.7x6   |
| FKT-125-O   | <a href="#">21950</a> | 1.250       |               | 0.305 | 2.500 | 6.375 | 5.000 | 1.375 | 0.190 | 1.250 | O **               | KPS-31-125    | <a href="#">28850</a> | M4-.7x6   |
| Metric      |                       |             | Dia. Range    | E     | H     | L     | L1    | L2    | P     | T     | Knurl Wheel Series | Knurl Pin Set |                       | Set Screw |
| Description | UPC #                 | CH & S mm   |               |       |       |       |       |       |       |       |                    | Description   | UPC #                 |           |
| FKT-10-D    | <a href="#">21905</a> | 10          | 6.4 & up***   | 3.4   | 25.4  | 85.7  | 63.5  | 22.2  | 1.5   | 12.7  | D *                | KPS-18-50     | <a href="#">28805</a> | M3-.5x3   |
| FKT-12-D    | <a href="#">21915</a> | 12          |               | 3.4   | 25.4  | 92.1  | 69.9  | 22.2  | 1.5   | 12.7  | D *                | KPS-18-50     | <a href="#">28805</a> | M3-.5x3   |
| FKT-162-D   | <a href="#">21955</a> | 16          |               | 3.4   | 28.6  | 101.6 | 76.2  | 25.4  | 1.5   | 15.9  | D *                | KPS-18-62     | <a href="#">28810</a> | M3-.5x3   |
| FKT-20-M    | <a href="#">21925</a> | 20          | 8 & up***     | 6.4   | 50.8  | 120.7 | 82.6  | 38.1  | 4.8   | 19.1  | M **               | KPS-31-75     | <a href="#">28840</a> | M4-.7x6   |
| FKT-25-M    | <a href="#">21935</a> | 25          |               | 6.4   | 50.8  | 139.7 | 101.6 | 38.1  | 4.8   | 25.4  | M **               | KPS-31-100    | <a href="#">28845</a> | M4-.7x6   |
| FKT-32-O    | <a href="#">21945</a> | 32          |               | 7.7   | 63.5  | 161.9 | 127.0 | 34.9  | 4.8   | 31.8  | O **               | KPS-31-125    | <a href="#">28850</a> | M4-.7x6   |

Supplied with one (1) set of diagonal high speed beveled TiN coated knurl wheels, \*30 TPI, \*\* 25 TPI  
 \*\*\* Warning: May cause deflection on small part diameters, and too much pressure on large diameters

# Single Shoulder Wheel Fixed Forming Knurling Tool

## SSWFKT - Single Shoulder Wheel Fixed Forming Knurling Tool



- Precision square shank with preset center height
- Designed to knurl against a square shoulder
- Single wheel knurling tool for general purposes
- Knurl wheel is mounted on a thrust washer to ensure a smooth and even rotation of the knurl
- Can be reversed for right or left hand operation



## Resulting Knurl Pattern

Straight pattern with straight wheel



Straight

Male 60° diamond pattern with female wheel



Female

## Recommended Use:

For best results, use beveled knurl wheel. In-feed the knurling tool into the blank until the right pattern is generated, then end-feed for straight pattern. Do not end-feed for diamond pattern.

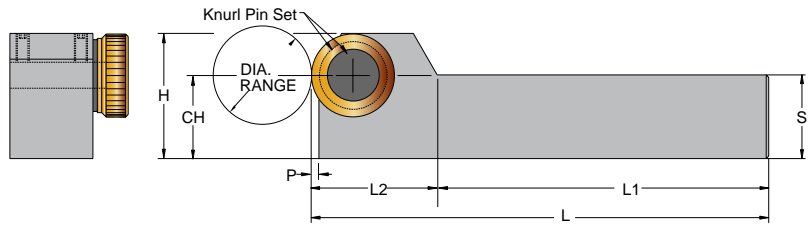
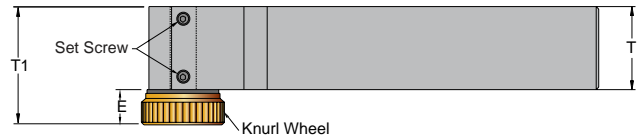

| Inch<br>Description   | UPC #                 | CH & S<br>inch | Dia. Range   | E     | H     | L     | L1    | L2    | P     | T     | T1    | Knurl<br>Wheel<br>Series | Knurl Pin Set |                       | Set<br>Screw |
|-----------------------|-----------------------|----------------|--------------|-------|-------|-------|-------|-------|-------|-------|-------|--------------------------|---------------|-----------------------|--------------|
|                       |                       |                |              |       |       |       |       |       |       |       |       |                          | Description   | UPC #                 |              |
| SSWFKT-38-2           | <a href="#">21777</a> | 0.375          | Unlimited*** | 0.265 | 0.625 | 3.125 | 2.500 | 0.625 | 0.050 | 0.500 | 0.765 | SW2 *                    | SW2.0P-1S     | <a href="#">29050</a> | M3-.5x3      |
| SSWFKT-50-2           | <a href="#">21781</a> | 0.500          | Unlimited*** | 0.265 | 0.750 | 3.375 | 2.750 | 0.625 | 0.050 | 0.500 | 0.765 | SW2 *                    | SW2.0P-1S     | <a href="#">29050</a> | M3-.5x3      |
| SSWFKT-162-2          | <a href="#">21783</a> | 0.625          | Unlimited*** | 0.265 | 0.875 | 3.625 | 3.000 | 0.625 | 0.050 | 0.625 | 0.890 | SW2 *                    | SW2.0P-1S     | <a href="#">29050</a> | M3-.5x3      |
| SSWFKT-75-4           | <a href="#">21789</a> | 0.750          | Unlimited*** | 0.410 | 1.250 | 4.500 | 3.250 | 1.250 | 0.050 | 0.750 | 1.160 | SW4 **                   | SW4.0P-1S     | <a href="#">29080</a> | M4-.7x5      |
| SSWFKT-100-4          | <a href="#">21793</a> | 1.000          | Unlimited*** | 0.410 | 1.500 | 5.250 | 4.000 | 1.250 | 0.050 | 1.000 | 1.410 | SW4 **                   | SW4.0P-1S     | <a href="#">29080</a> | M4-.7x5      |
| SSWFKT-125-4          | <a href="#">21797</a> | 1.250          | Unlimited*** | 0.410 | 1.750 | 6.250 | 5.000 | 1.250 | 0.050 | 1.250 | 1.660 | SW4 **                   | SW4.0P-1S     | <a href="#">29080</a> | M5-.8x5      |
| Metric<br>Description | UPC #                 | CH & S<br>mm   | Dia. Range   | E     | H     | L     | L1    | L2    | P     | T     | T1    | Knurl<br>Wheel<br>Series | Knurl Pin Set |                       | Set<br>Screw |
| SSWFKT-10-2           | <a href="#">21775</a> | 10             | Unlimited*** | 6.7   | 15.9  | 79.4  | 63.5  | 15.9  | 1.3   | 12.7  | 19.4  | SW2 *                    | SW2.0P-1S     | <a href="#">29050</a> | M3-.5x3      |
| SSWFKT-12-2           | <a href="#">21779</a> | 12             | Unlimited*** | 6.7   | 19.1  | 85.7  | 69.9  | 15.9  | 1.3   | 12.7  | 19.4  | SW2 *                    | SW2.0P-1S     | <a href="#">29050</a> | M3-.5x3      |
| SSWFKT-162-2          | <a href="#">21783</a> | 16             | Unlimited*** | 6.7   | 22.2  | 92.1  | 76.2  | 15.9  | 1.3   | 15.9  | 22.6  | SW2 *                    | SW2.0P-1S     | <a href="#">29050</a> | M3-.5x3      |
| SSWFKT-20-4           | <a href="#">21787</a> | 20             | Unlimited*** | 10.4  | 31.8  | 114.3 | 82.6  | 31.8  | 1.3   | 19.1  | 29.5  | SW4 **                   | SW4.0P-1S     | <a href="#">29080</a> | M4-.7x5      |
| SSWFKT-25-4           | <a href="#">21791</a> | 25             | Unlimited*** | 10.4  | 38.1  | 133.4 | 101.6 | 31.8  | 1.3   | 25.4  | 35.8  | SW4 **                   | SW4.0P-1S     | <a href="#">29080</a> | M4-.7x5      |
| SSWFKT-32-4           | <a href="#">21795</a> | 32             | Unlimited*** | 10.4  | 44.5  | 158.8 | 127.0 | 31.8  | 1.3   | 31.8  | 42.2  | SW4 **                   | SW4.0P-1S     | <a href="#">29080</a> | M5-.8x5      |

Supplied with one (1) beveled straight high speed TiN coated knurl wheel, \* 30 TPI (0.8mm), \*\* 25 TPI (1.00mm)  
 \*\*\* Warning: May cause deflection on small part diameters, and too much pressure on large diameters

## SFKT - Shoulder Fixed Forming Knurling Tool



- Precision square shank with preset center height
- Designed to knurl against a square shoulder
- Twin knurl wheels for straight or diamond pattern
- Knurl wheels are mounted on a thrust washer to ensure a smooth and even rotation of the knurl
- Can be reversed for right or left hand operation

## Resulting Knurl Pattern

Straight pattern with straight wheels



Straight

Male 60° diamond pattern with diagonal wheels



Left

Right

## Recommended Use:

For best results, use beveled knurl wheels. In-feed the knurling tool into the blank until the right pattern is generated, then end-feed.

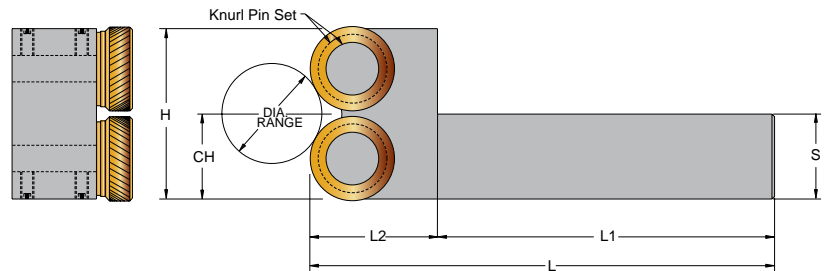
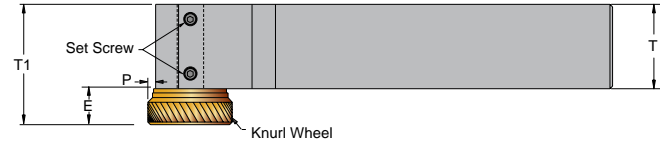

| Inch Description   | UPC #                 | CH & S inch | Dia. Range    | E     | H     | L     | L1    | L2    | P     | T     | T1    | Knurl Wheel Series | Knurl Pin Set |                       | Set Screw |
|--------------------|-----------------------|-------------|---------------|-------|-------|-------|-------|-------|-------|-------|-------|--------------------|---------------|-----------------------|-----------|
|                    |                       |             |               |       |       |       |       |       |       |       |       |                    | Description   | UPC #                 |           |
| SFKT-38-2          | <a href="#">22010</a> | 0.375       | 1/4" & up***  | 0.265 | 1.000 | 3.125 | 2.500 | 0.625 | 0.050 | 0.500 | 0.765 | SW2 *              | SW2.0P-2S     | <a href="#">29055</a> | M3-.5x3   |
| SFKT-50-2          | <a href="#">22020</a> | 0.500       |               | 0.265 | 1.000 | 3.375 | 2.750 | 0.625 | 0.050 | 0.500 | 0.765 | SW2 *              | SW2.0P-2S     | <a href="#">29055</a> | M3-.5x3   |
| SFKT-162-2         | <a href="#">22055</a> | 0.625       |               | 0.265 | 1.125 | 4.000 | 3.250 | 0.750 | 0.050 | 0.625 | 0.890 | SW2 *              | SW2.0P-2S     | <a href="#">29055</a> | M3-.5x3   |
| SFKT-75-4          | <a href="#">22030</a> | 0.750       | 5/16" & up*** | 0.410 | 2.000 | 4.375 | 3.250 | 1.125 | 0.050 | 0.750 | 1.160 | SW4 **             | SW4.0P-2S     | <a href="#">29085</a> | M5-.8x5   |
| SFKT-100-4         | <a href="#">22040</a> | 1.000       |               | 0.410 | 2.000 | 5.125 | 4.000 | 1.125 | 0.050 | 1.000 | 1.410 | SW4 **             | SW4.0P-2S     | <a href="#">29085</a> | M5-.8x5   |
| SFKT-125-4         | <a href="#">22050</a> | 1.250       |               | 0.410 | 2.500 | 6.375 | 5.000 | 1.375 | 0.050 | 1.250 | 1.660 | SW4 **             | SW4.0P-2S     | <a href="#">29085</a> | M5-.8x8   |
| Metric Description | UPC #                 | CH & S mm   | Dia. Range    | E     | H     | L     | L1    | L2    | P     | T     | T1    | Knurl Wheel Series | Knurl Pin Set |                       | Set Screw |
| SFKT-10-2          | <a href="#">22005</a> | 10          | 6,4mm & up*** | 6.7   | 25.4  | 79.4  | 63.5  | 15.9  | 1.3   | 12.7  | 19.4  | SW2 *              | SW2.0P-2S     | <a href="#">29055</a> | M3-.5x3   |
| SFKT-12-2          | <a href="#">22015</a> | 12          |               | 6.7   | 25.4  | 85.7  | 69.9  | 15.9  | 1.3   | 12.7  | 19.4  | SW2 *              | SW2.0P-2S     | <a href="#">29055</a> | M3-.5x3   |
| SFKT-162-2         | <a href="#">22055</a> | 16          |               | 6.7   | 28.6  | 101.6 | 82.6  | 19.1  | 1.3   | 19.1  | 22.6  | SW2 *              | SW2.0P-2S     | <a href="#">29055</a> | M3-.5x3   |
| SFKT-20-4          | <a href="#">22025</a> | 20          | 8mm & up***   | 10.4  | 50.8  | 111.1 | 82.6  | 28.6  | 1.3   | 19.1  | 29.5  | SW4 **             | SW4.0P-2S     | <a href="#">29085</a> | M5-.8x5   |
| SFKT-25-4          | <a href="#">22035</a> | 25          |               | 10.4  | 50.8  | 130.2 | 101.6 | 28.6  | 1.3   | 25.4  | 35.8  | SW4 **             | SW4.0P-2S     | <a href="#">29085</a> | M5-.8x5   |
| SFKT-32-4          | <a href="#">22045</a> | 32          |               | 10.4  | 63.5  | 161.9 | 127.0 | 34.9  | 1.3   | 31.8  | 42.2  | SW4 **             | SW4.0P-2S     | <a href="#">29085</a> | M5-.8x8   |

Supplied with one (1) set of beveled diagonal high speed TiN coated knurl wheels, \* 30 TPI (0.8mm), \*\* 25 TPI (1.0mm)  
 \*\*\* Warning: May cause deflections on small part diameters, and too much pressure on large diameters

# Internal Forming Knurling Tool

## TIKT - True Internal Forming Knurling Tool



- For true internal knurling requiring a straight or diamond pattern
- True internal knurling is used to reduce oversized internal diameters or for specific knurling applications
- Knurl wheel is mounted between thrust washers to ensure a smooth and even rotation of the knurl
- Single wheel knurling tool

## Resulting Knurl Pattern

Straight pattern with straight wheel



Straight

Male 60° diamond pattern with female wheel



Female

## Recommended Use:

For best results, use beveled knurl wheel. In-feed the knurling tool into the blank until the right pattern is generated, then end-feed for straight pattern. Do not end-feed for diamond pattern.

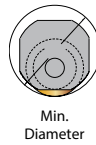

Min. Diameter

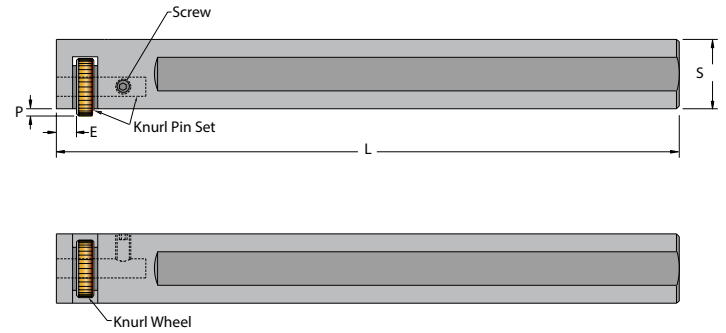

| Inch        |                       | S<br>inch | Min. Diameter | E     | L      | P     | Knurl<br>Wheel<br>Series | Knurl Pin Set |                       | Set Screw |
|-------------|-----------------------|-----------|---------------|-------|--------|-------|--------------------------|---------------|-----------------------|-----------|
| Description | UPC #                 |           |               |       |        |       |                          | Description   | UPC #                 |           |
| TIKT-50-B   | 22611                 | 0.500     | 0.562"        | 0.100 | 4.000  | 0.030 | B *                      | KPS-12-38     | <a href="#">28800</a> | M3-.5x5   |
| TIKT-75-D   | <a href="#">22621</a> | 0.750     | 1.000"        | 0.115 | 6.125  | 0.060 | D *                      | KPS-18-50     | <a href="#">28805</a> | M3-.5x5   |
| TIKT-100-R  | <a href="#">22631</a> | 1.000     | 1.190"        | 0.170 | 8.000  | 0.090 | R **                     | KPS-25-75     | <a href="#">28820</a> | M4-.7x8   |
| TIKT-125-M  | <a href="#">22641</a> | 1.250     | 1.500"        | 0.190 | 10.000 | 0.110 | M **                     | KPS-31-100    | <a href="#">28845</a> | M4-.7x8   |
| Metric      |                       | S<br>mm   | Min. Diameter | E     | L      | P     | Knurl<br>Wheel<br>Series | Knurl Pin Set |                       | Set Screw |
| Description | UPC #                 |           |               |       |        |       |                          | Description   | UPC #                 |           |
| TIKT-12-B   | <a href="#">22601</a> | 12        | 14.3mm        | 2.5   | 101.6  | 0.8   | B *                      | KPS-12-38     | <a href="#">28800</a> | M3-.5x5   |
| TIKT-20-D   | <a href="#">22616</a> | 20        | 25.4mm        | 2.9   | 155.6  | 1.5   | D *                      | KPS-18-50     | <a href="#">28805</a> | M3-.5x5   |
| TIKT-25-R   | <a href="#">22626</a> | 25        | 30.2mm        | 4.3   | 203.2  | 2.3   | R **                     | KPS-25-75     | <a href="#">28820</a> | M4-.7x8   |
| TIKT-32-M   | <a href="#">22636</a> | 32        | 38.1mm        | 4.8   | 254.0  | 2.8   | M **                     | KPS-31-100    | <a href="#">28845</a> | M4-.7x8   |

Supplied with one (1) beveled straight high speed TiN coated knurl wheel, \*30 TPI (0.8mm), \*\*25 TPI (1.0mm)

## SIKT - Shoulder Internal Forming Knurling Tool



- For internal knurling requiring a straight or diamond pattern
- Designed to knurl against a square shoulder
- Internal knurling is used to reduce oversized internal diameters or for specific knurling applications
- Knurl wheel is mounted on a thrust washer to ensure a smooth and even rotation of the knurl
- Single wheel knurling tool

## Resulting Knurl Pattern

Straight pattern with straight wheel



Straight

Male 60° diamond pattern with female wheel



Female

## Recommended Use:

For best results, use beveled knurl wheel. In-feed the knurling tool into the blank until the right pattern is generated, then end-feed for straight pattern. Do not end-feed for diamond pattern.

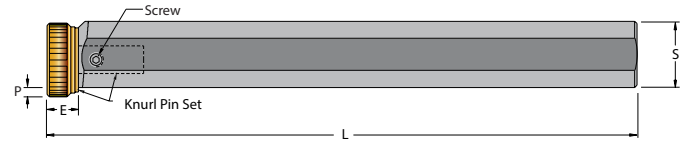
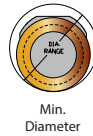

| Inch<br>Description   | UPC #                 | S<br>inch | Min. Diameter | E     | L      | P     | Knurl<br>Wheel<br>Series | Knurl Pin Set |                       | Set Screw |
|-----------------------|-----------------------|-----------|---------------|-------|--------|-------|--------------------------|---------------|-----------------------|-----------|
|                       |                       |           |               |       |        |       |                          | Description   | UPC #                 |           |
| SIKT-50-2             | <a href="#">22610</a> | 0.500     | 0.562"        | 0.265 | 4.000  | 0.050 | SW2 *                    | SW2.0P-1S     | <a href="#">29050</a> | M4-.7x4   |
| SIKT-75-4             | <a href="#">22620</a> | 0.750     | 1.125"        | 0.410 | 6.125  | 0.050 | SW4 **                   | SW4.0P-1S     | <a href="#">29080</a> | M5-.8x5   |
| SIKT-100-4            | <a href="#">22630</a> | 1.000     | 1.125"        | 0.410 | 8.000  | 0.050 | SW4 **                   | SW4.0P-1S     | <a href="#">29080</a> | M5-.8x5   |
| SIKT-125-4            | <a href="#">22640</a> | 1.250     | 1.375"        | 0.410 | 10.000 | 0.050 | SW4 **                   | SW4.0P-1S     | <a href="#">29080</a> | M5-.8x5   |
| Metric                |                       |           |               |       |        |       |                          |               |                       |           |
| Metric<br>Description | UPC #                 | S<br>mm   | Min. Diameter | E     | L      | P     | Knurl<br>Wheel<br>Series | Knurl Pin Set |                       | Set Screw |
|                       |                       |           |               |       |        |       |                          | Description   | UPC #                 |           |
| SIKT-12-2             | <a href="#">22605</a> | 12        | 14.3mm        | 6.7   | 101.6  | 1.3   | SW2 *                    | SW2.0P-1S     | <a href="#">29050</a> | M4-.7x4   |
| SIKT-20-4             | <a href="#">22615</a> | 20        | 28.6mm        | 10.4  | 155.6  | 1.3   | SW4 **                   | SW4.0P-1S     | <a href="#">29080</a> | M5-.8x5   |
| SIKT-25-4             | <a href="#">22625</a> | 25        | 28.6mm        | 10.4  | 203.2  | 1.3   | SW4 **                   | SW4.0P-1S     | <a href="#">29080</a> | M5-.8x5   |
| SIKT-32-4             | <a href="#">22635</a> | 32        | 35.0mm        | 10.4  | 254.0  | 1.3   | SW4 **                   | SW4.0P-1S     | <a href="#">29080</a> | M5-.8x5   |

Supplied with one (1) beveled straight high speed TiN coated knurl wheel, \* 30 TPI (0.8mm), \*\* 25 TPI (1mm)

# Milling Machine Forming Knurling Tool

## MMKT - Milling Machine Forming Knurling Tool



- Specifically designed to knurl a flat surface
- Tool has been engineered to be used on milling machines
- Ground Weldon shank to fit in the milling holders
- Knurl wheel is mounted between thrust washers to ensure a smooth and even rotation of the knurl
- Single wheel knurling tool

## Resulting Knurl Pattern

Straight pattern with straight wheel



Straight

Male 60° diamond pattern with female wheel



Female

Female 60° diamond pattern with male wheel



Male

## Recommended Use:

For best results, use beveled knurl wheel. In-feed the knurling tool into the blank until the right pattern is generated, then end-feed.

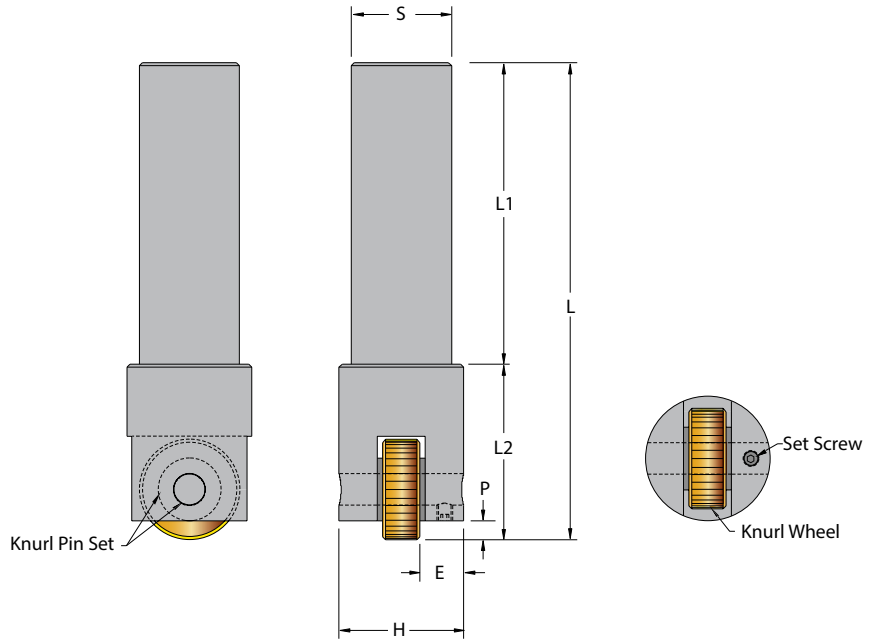

| Inch<br>Description   | UPC #                 | S<br>inch | E     | H     | L     | L1    | L2    | P     | Knurl<br>Wheel<br>Series | Knurl Pin Set |                       | Set Screw |
|-----------------------|-----------------------|-----------|-------|-------|-------|-------|-------|-------|--------------------------|---------------|-----------------------|-----------|
|                       |                       |           |       |       |       |       |       |       |                          | Description   | UPC #                 |           |
| MMKT-38-D             | <a href="#">22510</a> | 0.375     | 0.235 | 0.625 | 2.375 | 1.500 | 0.875 | 0.060 | D *                      | KPS-18-62     | <a href="#">28810</a> | M3-.5x3   |
| MMKT-50-R             | <a href="#">22520</a> | 0.500     | 0.340 | 0.875 | 3.125 | 2.000 | 1.125 | 0.100 | R **                     | KPS-25-87     | <a href="#">28825</a> | M3-.5x4   |
| MMKT-75-O             | <a href="#">22530</a> | 0.750     | 0.312 | 1.000 | 4.000 | 2.500 | 1.500 | 0.190 | O **                     | KPS-31-100    | <a href="#">28845</a> | M3-.5x4   |
| MMKT-100-O            | <a href="#">22540</a> | 1.000     | 0.437 | 1.250 | 4.750 | 3.000 | 1.750 | 0.190 | O **                     | KPS-31-125    | <a href="#">28850</a> | M4-.7x4   |
| MMKT-125-P            | <a href="#">22550</a> | 1.250     | 0.500 | 1.500 | 5.625 | 3.500 | 2.125 | 0.125 | P **                     | KPS-50-150    | <a href="#">28860</a> | M4-.7x6   |
| Metric<br>Description | UPC #                 | S<br>mm   | E     | H     | L     | L1    | L2    | P     | Knurl<br>Wheel<br>Series | Knurl Pin Set |                       | Set Screw |
| MMKT-10-D             | <a href="#">22505</a> | 10        | 6.0   | 15.9  | 60.3  | 38.1  | 22.2  | 1.5   | D *                      | KPS-18-62     | <a href="#">28810</a> | M3-.5x3   |
| MMKT-12-R             | <a href="#">22515</a> | 12        | 8.6   | 22.2  | 79.4  | 50.8  | 28.6  | 2.5   | R **                     | KPS-25-87     | <a href="#">28825</a> | M3-.5x4   |
| MMKT-20-O             | <a href="#">22525</a> | 20        | 7.9   | 25.4  | 101.6 | 63.5  | 38.1  | 4.8   | O **                     | KPS-31-100    | <a href="#">28845</a> | M3-.5x4   |
| MMKT-25-O             | <a href="#">22535</a> | 25        | 11.1  | 31.8  | 120.7 | 76.2  | 44.5  | 4.8   | O **                     | KPS-31-125    | <a href="#">28850</a> | M4-.7x4   |
| MMKT-32-P             | <a href="#">22545</a> | 32        | 12.7  | 38.1  | 142.9 | 88.9  | 54.0  | 3.2   | P **                     | KPS-50-150    | <a href="#">28860</a> | M4-.7x6   |

Supplied with one (1) beveled straight high speed TiN coated knurl wheel, \*30 TPI (0.8mm), \*\*25 TPI (1.0mm)

**Diametral Forming Knurling Tools** A diametral adjustment screw regulates the depth of the knurl pattern and the diameter size. The floating head will allow the knurl wheel to self adjust on the work piece - even when the work piece is not perfectly concentric. However, the tool can be used for twin wheel applications or single wheel knurling applications. This tool comes with a square shank to be used on open slot tool holders, or on a square index turret, with a preset center height adjustment which will meet the fixed center height of the CNC and the turret lathe. Body and shank are made of heat-treated, precision ground alloy steel. The dovetail guide ensures the most precise accuracy and rigidity for infinite diameter settings.

### Heavy Duty Style Forming Knurling Tool

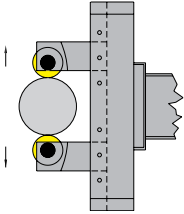

**Straddle application** is best when pressure and deflection are a problem. The knurling arms are able to "float" somewhat and center on the workpiece, compensating for any off-centering. It has been developed to make a perfect knurling pattern without putting any pressure on the spindle or on the lathe compound.

Uses 2 wheels  
for straight pattern

Uses 2 wheels  
for 60° diamond pattern  
1 Diag. Lt.  
1 Diag. Rt.

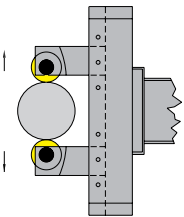

**Bump application** is best for narrow knurling applications. The knurling arms are moved closer together so that the tool can "bump" against the side of the working part with two wheels touching the part.

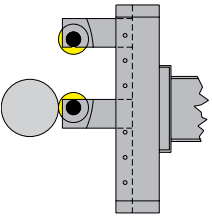

**Single wheel application** is best for narrow and quick knurling setup. The knurling arms are moved up so that the bottom knurling wheel is locked on center and can "bump" against the side of the working part. With one wheel touching the part, this configuration allows for a quicker setup and knurling of narrow knurling applications.



Knurl wheels are supported in a flanged nest to offer best rigidity to handle heavy duty knurling. The knurl wheels are mounted between thrust washers to insure a smooth and even rotation while knurling is performed.

### Shoulder Style Forming Knurling Tool

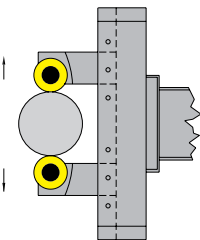

**Straddle application** is best when pressure and deflection are a problem. The knurling arms are able to "float" somewhat and center on the workpiece, compensating for any off-centering. It has been developed to make a perfect knurling pattern without putting any pressure on the spindle or on the lathe compound.

Uses 2 wheels  
for straight pattern

Uses 2 wheels  
for 60° diamond pattern  
1 Diag. Lt.  
1 Diag. Rt.

Designed to knurl against a square shoulder. The knurl wheels are mounted on a thrust washer to insure a smooth and even rotation while knurling is performed. The wheels are held at slight pitch to the work part for better end feeding (feeding across the part towards the chuck).

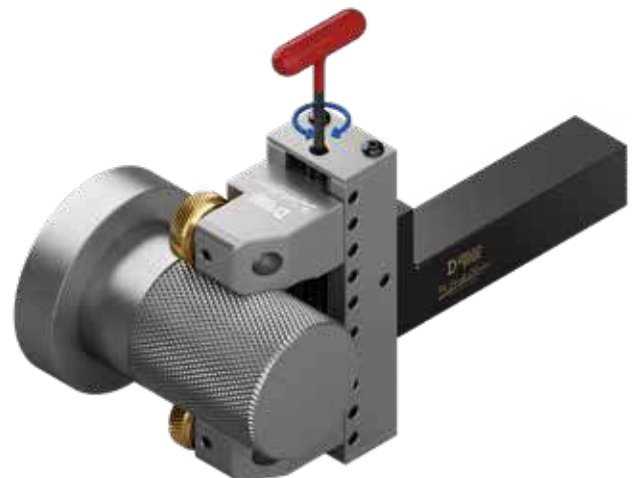

# Diametral Forming Knurling Tools

## KTM109 Heavy Duty Style Straddle Square Shank Knurling Tool



- Precision square shank with preset center height
- Adjustable heavy duty arms for precise workpiece diameter setting
- Can be reversed for right or left hand operation
- Knurl wheels are mounted between thrust washers to ensure a smooth and even rotation of the knurls
- Twin knurl wheels for straight or diamond pattern



1.5" & 2.5"  
(38mm & 63,5mm)  
Diameter Range

## Resulting Knurl Pattern

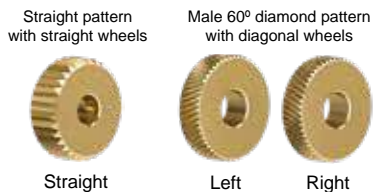

## Recommended Use:

For best results, use beveled knurl wheels. In-feed the knurling tool into the blank until the right pattern is generated, then end-feed.

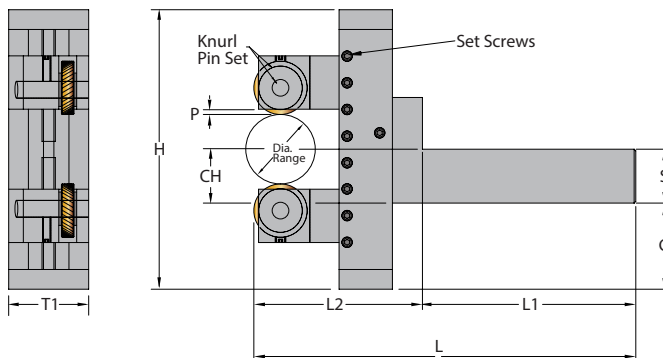
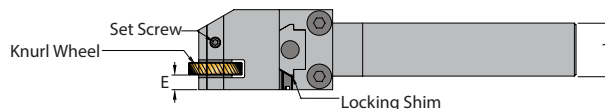

| Inch Description                | UPC #                 | CH & S inch | Dia. Range     | E     | G     | H     | L     | L1    | L2    | P     | T     | T1    | Knurl Wheel Series | Knurl Arm Set ** |             | Set Screw |
|---------------------------------|-----------------------|-------------|----------------|-------|-------|-------|-------|-------|-------|-------|-------|-------|--------------------|------------------|-------------|-----------|
|                                 |                       |             |                |       |       |       |       |       |       |       |       |       |                    | Supplied         | Optional    |           |
| <b>1.5" Max. Diameter Range</b> |                       |             |                |       |       |       |       |       |       |       |       |       |                    |                  |             |           |
| KTM109-75-15-M                  | <a href="#">22814</a> | 0.750       | 0 - 1.50" ***  | 0.250 | 1.250 | 4.000 | 6.625 | 3.250 | 3.375 | 0.188 | 1.000 | 1.500 | M*                 | W109-3-25-M      | W109-3-25-4 | M5-.8x5   |
| KTM109-100-15-M                 | <a href="#">22816</a> | 1.000       |                | 0.250 | 1.000 | 4.000 | 7.375 | 4.000 | 3.375 | 0.188 | 1.000 | 1.500 | M*                 | W109-3-25-M      | W109-3-25-4 | M5-.8x5   |
| KTM109-125-15-M                 | <a href="#">22818</a> | 1.250       |                | 0.250 | 0.750 | 4.000 | 8.375 | 5.000 | 3.375 | 0.188 | 1.250 | 1.500 | M*                 | W109-3-25-M      | W109-3-25-4 | M5-.8x5   |
| <b>2.5" Max. Diameter Range</b> |                       |             |                |       |       |       |       |       |       |       |       |       |                    |                  |             |           |
| KTM109-75-25-M                  | <a href="#">22823</a> | 0.750       | .125-2.50" *** | 0.250 | 1.688 | 4.875 | 6.625 | 3.250 | 3.375 | 0.188 | 1.00  | 1.50  | M*                 | W109-3-25-M      | W109-3-25-4 | M5-.8x5   |
| KTM109-100-25-M                 | <a href="#">22824</a> | 1.000       |                | 0.250 | 1.437 | 4.875 | 7.375 | 4.000 | 3.375 | 0.188 | 1.00  | 1.50  | M*                 | W109-3-25-M      | W109-3-25-4 | M5-.8x5   |
| KTM109-125-25-M                 | <a href="#">22826</a> | 1.250       |                | 0.250 | 1.188 | 4.875 | 8.375 | 5.000 | 3.375 | 0.188 | 1.25  | 1.50  | M*                 | W109-3-25-M      | W109-3-25-4 | M5-.8x5   |
| <b>Metric</b>                   |                       |             |                |       |       |       |       |       |       |       |       |       |                    |                  |             |           |
| Metric Description              | UPC #                 | CH & S mm   | Dia. Range     | E     | G     | H     | L     | L1    | L2    | P     | T     | T1    | Knurl Wheel Series | Knurl Arm Set ** |             | Set Screw |
| <b>38mm Max. Diameter Range</b> |                       |             |                |       |       |       |       |       |       |       |       |       |                    |                  |             |           |
| KTM109-20-15-M                  | 22811                 | 20          | 0 - 38mm***    | 6.4   | 31.8  | 101.6 | 168.3 | 82.6  | 85.7  | 4.8   | 25.4  | 38.1  | M*                 | W109-3-25-M      | W109-3-25-4 | M5-.8x5   |
| KTM109-25-15-M                  | <a href="#">22812</a> | 25          |                | 6.4   | 25.4  | 101.6 | 187.3 | 101.6 | 85.7  | 4.8   | 25.4  | 38.1  | M*                 | W109-3-25-M      | W109-3-25-4 | M5-.8x5   |
| KTM109-32-15-M                  | <a href="#">22813</a> | 32          |                | 6.4   | 19.1  | 101.6 | 212.7 | 127.0 | 85.7  | 4.8   | 31.8  | 38.1  | M*                 | W109-3-25-M      | W109-3-25-4 | M5-.8x5   |
| <b>63mm Max. Diameter Range</b> |                       |             |                |       |       |       |       |       |       |       |       |       |                    |                  |             |           |
| KTM109-20-25-M                  | <a href="#">22819</a> | 20          | 32-63mm***     | 6.4   | 42.9  | 123.8 | 168.3 | 82.6  | 85.7  | 4.8   | 25.4  | 38.1  | M*                 | W109-3-25-M      | W109-3-25-4 | M5-.8x5   |
| KTM109-25-25-M                  | <a href="#">22821</a> | 25          |                | 6.4   | 36.5  | 123.8 | 187.3 | 101.6 | 85.7  | 4.8   | 25.4  | 38.1  | M*                 | W109-3-25-M      | W109-3-25-4 | M5-.8x5   |
| KTM109-32-25-M                  | <a href="#">22822</a> | 32          |                | 6.4   | 30.2  | 123.8 | 212.7 | 127.0 | 85.7  | 4.8   | 31.8  | 38.1  | M*                 | W109-3-25-M      | W109-3-25-4 | M5-.8x5   |

\* Supplied with one (1) set of beveled diagonal high speed TiN coated knurl wheels for a male diamond pattern, 25 TPI (1.00mm)

\*\* See Page H-54 for optional arms and specifications

\*\*\*Warning: This tool has the capability to adjust the wheels until they touch, but physically applying a knurl on small diameters may not be possible

## KTW109 Shoulder Style Straddle Square Shank Forming Knurling Tool



- Precision square shank with preset center height
- Adjustable heavy duty arms for precise workpiece diameter setting
- Can be reversed for right or left hand operation
- Knurl wheels are mounted between thrust washers to ensure a smooth and even rotation of the knurls
- Twin knurl wheels for straight or diamond pattern to a shoulder

## Resulting Knurl Pattern

Straight pattern with straight wheels



Straight

Male 60° diamond pattern with diagonal wheels



Left

Right

## Recommended Use:

For best results, use beveled knurl wheels. In-feed the knurling tool into the blank until the right pattern is generated, then end-feed.

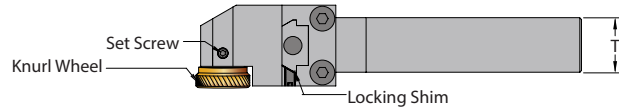

1.5" & 2.5"  
(38mm & 63,5mm)  
Diameter Range

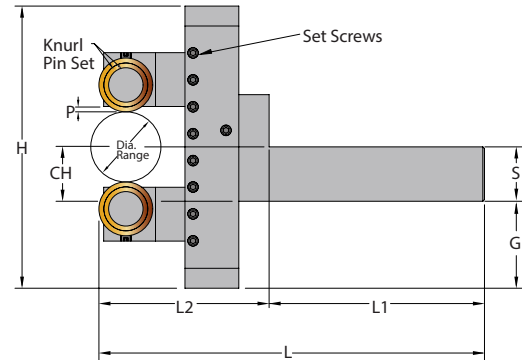
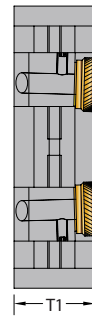

| Inch Description                | UPC # | CH & S inch | Dia. Range   | G      | H      | L      | L1     | L2     | P     | T     | T1    | Knurl Wheel Series | Knurl Arm Set ** |             | Set Screw |
|---------------------------------|-------|-------------|--------------|--------|--------|--------|--------|--------|-------|-------|-------|--------------------|------------------|-------------|-----------|
|                                 |       |             |              |        |        |        |        |        |       |       |       |                    | Supplied         | Optional    |           |
| <b>1.5" Max. Diameter Range</b> |       |             |              |        |        |        |        |        |       |       |       |                    |                  |             |           |
| KTW109-75-15-4                  | 22832 | 0.750       | 0-1.50***    | 1.250  | 4.000  | 6.625  | 3.250  | 3.375  | 0.050 | 1.000 | 1.500 | SW4*               | W109-3-25-4      | W109-3-25-M | M5-.8x5   |
| KTW109-100-15-4                 | 22833 | 1.000       |              | 1.000  | 4.000  | 7.375  | 4.000  | 3.375  | 0.050 | 1.000 | 1.500 | SW4*               | W109-3-25-4      | W109-3-25-M | M5-.8x5   |
| KTW109-125-15-4                 | 22834 | 1.250       |              | 0.750  | 4.000  | 8.375  | 5.000  | 3.375  | 0.050 | 1.250 | 1.500 | SW4*               | W109-3-25-4      | W109-3-25-M | M5-.8x5   |
| <b>2.5" Max. Diameter Range</b> |       |             |              |        |        |        |        |        |       |       |       |                    |                  |             |           |
| KTW109-75-25-4                  | 22841 | 0.750       | .125-2.50*** | 1.688  | 4.875  | 6.625  | 3.250  | 3.375  | 0.050 | 1.00  | 1.50  | SW4*               | W109-3-25-M      | W109-3-25-4 | M5-.8x5   |
| KTW109-100-25-4                 | 22842 | 1.000       |              | 1.437  | 4.875  | 7.375  | 4.000  | 3.375  | 0.050 | 1.00  | 1.50  | SW4*               | W109-3-25-M      | W109-3-25-4 | M5-.8x5   |
| KTW109-125-25-4                 | 22843 | 1.250       |              | 1.188  | 4.875  | 8.375  | 5.000  | 3.375  | 0.050 | 1.25  | 1.50  | SW4*               | W109-3-25-M      | W109-3-25-4 | M5-.8x5   |
| <b>Metric</b>                   |       |             |              |        |        |        |        |        |       |       |       |                    |                  |             |           |
| Metric Description              | UPC # | CH & S mm   | Dia. Range   | G      | H      | L      | L1     | L2     | P     | T     | T1    | Knurl Wheel Series | Knurl Arm Set ** |             | Set Screw |
| <b>38mm Max. Diameter Range</b> |       |             |              |        |        |        |        |        |       |       |       |                    |                  |             |           |
| KTW109-20-15-4                  | 22828 | 20          | 0-38mm***    | 31.8   | 101.6  | 168.3  | 82.6   | 85.7   | 1.3   | 25.4  | 38.1  | SW4*               | W109-3-25-4      | W109-3-25-M | M5-.8x5   |
| KTW109-25-15-4                  | 22829 | 25          |              | 25.4   | 101.6  | 187.3  | 101.6  | 85.7   | 1.3   | 25.4  | 38.1  | SW4*               | W109-3-25-4      | W109-3-25-M | M5-.8x5   |
| KTW109-32-15-4                  | 22831 | 32          |              | 19.1   | 101.6  | 212.7  | 127.0  | 85.7   | 1.3   | 31.8  | 38.1  | SW4*               | W109-3-25-4      | W109-3-25-M | M5-.8x5   |
| <b>63mm Max. Diameter Range</b> |       |             |              |        |        |        |        |        |       |       |       |                    |                  |             |           |
| KTW109-20-25-4                  | 22836 | 20          | 3.2-63mm***  | 2580.6 | 4274.8 | 2098.0 | 2176.8 | 2176.8 | 33.0  | 645.1 | 807.7 | SW4*               | W109-3-25-4      | W109-3-25-M | M5-.8x5   |
| KTW109-25-25-4                  | 22838 | 25          |              | 2580.6 | 4757.4 | 2580.6 | 2176.8 | 2176.8 | 33.0  | 645.1 | 807.7 | SW4*               | W109-3-25-4      | W109-3-25-M | M5-.8x5   |
| KTW109-32-25-4                  | 22839 | 32          |              | 2580.6 | 5402.5 | 3225.8 | 2176.8 | 2176.8 | 33.0  | 807.7 | 807.7 | SW4*               | W109-3-25-4      | W109-3-25-M | M5-.8x5   |

\* Supplied with one (1) set of beveled diagonal high speed TiN coated knurl wheels for a male diamond pattern, 25 TPI (1.00mm)

\*\* See Page H-54 for optional arms and specifications

\*\*\*Warning: This tool has the capability to adjust the wheels until they touch, but physically applying a knurl on small diameters may not be possible

# Diametral Forming Knurling Tools

## KTO109-40 Heavy Duty Style Straddle Square Shank Knurling Tool



- Precision square shank with preset center height
- Adjustable heavy duty arms for precise workpiece diameter setting
- Can be reversed for right or left hand operation
- Knurl wheels are mounted between thrust washers to ensure a smooth and even rotation of the knurls
- Twin knurl wheels for straight or diamond pattern

## Resulting Knurl Pattern

Straight pattern with straight wheels



Straight

Male 60° diamond pattern with diagonal wheels



Left



Right

## Recommended Use:

For best results, use beveled knurl wheels. In-feed the knurling tool into the blank until the right pattern is generated, then end-feed.

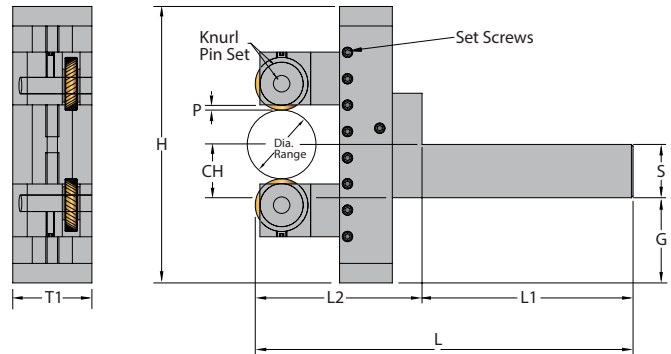
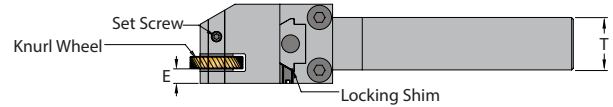

| Inch Description                 | UPC #                 | CH & S inch | Dia. Range  | E     | G     | H     | L     | L1    | L2    | P     | T    | T1   | Knurl Wheel Series | Knurl Arm Set ** |             | Set Screw |
|----------------------------------|-----------------------|-------------|-------------|-------|-------|-------|-------|-------|-------|-------|------|------|--------------------|------------------|-------------|-----------|
|                                  |                       |             |             |       |       |       |       |       |       |       |      |      |                    | Supplied         | Optional    |           |
| <b>4.0" Max. Diameter Range</b>  |                       |             |             |       |       |       |       |       |       |       |      |      |                    |                  |             |           |
| KTO109-100-40-O                  | <a href="#">22869</a> | 1.000       | .63-4.00*** | 0.250 | 2.174 | 6.347 | 9.875 | 5.000 | 4.875 | 0.188 | 1.25 | 2.00 | O*                 | W109-3-40-O      | W109-3-40-4 | M5-.8x6   |
| KTO109-125-40-O                  | <a href="#">22870</a> | 1.250       |             | 0.250 | 1.924 | 6.347 | 9.875 | 5.000 | 4.875 | 0.188 | 1.25 | 2.00 | O*                 | W109-3-40-O      | W109-3-40-4 | M5-.8x6   |
| <b>Metric</b>                    |                       |             |             |       |       |       |       |       |       |       |      |      |                    |                  |             |           |
| Metric Description               | UPC #                 | CH & S mm   | Dia. Range  | E     | G     | H     | L     | L1    | L2    | P     | T    | T1   | Knurl Wheel Series | Knurl Arm Set ** |             | Set Screw |
| <b>100mm Max. Diameter Range</b> |                       |             |             |       |       |       |       |       |       |       |      |      |                    |                  |             |           |
| KTO109-25-40-O                   | <a href="#">22867</a> | 25          | 16-100mm*** | 6.4   | 55.2  | 161.2 | 250.8 | 127.0 | 123.8 | 4.8   | 31.8 | 50.8 | O*                 | W109-3-40-O      | W109-3-40-4 | M5-.8x6   |
| KTO109-32-40-O                   | <a href="#">22868</a> | 32          |             | 6.4   | 48.9  | 161.2 | 250.8 | 127.0 | 123.8 | 4.8   | 31.8 | 50.8 | O*                 | W109-3-40-O      | W109-3-40-4 | M5-.8x6   |

\* Supplied with one (1) set of beveled diagonal high speed TiN coated knurl wheels for a male diamond pattern, 25 TPI (1.00mm)

\*\* See Page H-54 for optional arms and specifications

\*\*\*Warning: Physically applying a knurl on small diameters may not be possible

## KTW109-40 Shoulder Style Straddle Square Shank Knurling Tool



- Precision square shank with preset center height
- Adjustable heavy duty arms for precise workpiece diameter setting
- Can be reversed for right or left hand operation
- Knurl wheels are mounted between thrust washers to ensure a smooth and even rotation of the knurls
- Twin knurl wheels for straight or diamond pattern to a shoulder



## Resulting Knurl Pattern

Straight pattern with straight wheels



Straight

Male 60° diamond pattern with diagonal wheels



Left

Right

## Recommended Use:

For best results, use beveled knurl wheels. In-feed the knurling tool into the blank until the right pattern is generated, then end-feed.

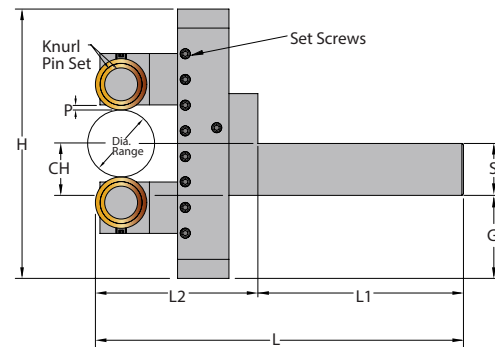
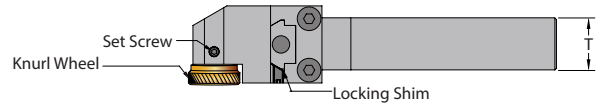

| Inch Description                 | UPC #                 | CH & S inch | Dia. Range    | G     | H     | L     | L1    | L2    | P     | T     | T1    | Knurl Wheel Series | Knurl Arm Set ** |             | Set Screw |
|----------------------------------|-----------------------|-------------|---------------|-------|-------|-------|-------|-------|-------|-------|-------|--------------------|------------------|-------------|-----------|
|                                  |                       |             |               |       |       |       |       |       |       |       |       |                    | Supplied         | Optional    |           |
| <b>4.0" Max. Diameter Range</b>  |                       |             |               |       |       |       |       |       |       |       |       |                    |                  |             |           |
| KTW109-100-40-4                  | <a href="#">22873</a> | 1.000       | .63-4.00" *** | 2.174 | 6.347 | 9.875 | 5.000 | 4.875 | 0.050 | 1.250 | 2.000 | SW4*               | W109-3-40-4      | W109-3-40-O | M5-.8x6   |
| KTW109-125-40-4                  | <a href="#">22874</a> | 1.250       |               | 1.924 | 6.347 | 9.875 | 5.000 | 4.875 | 0.050 | 1.250 | 2.000 | SW4*               | W109-3-40-4      | W109-3-40-O | M5-.8x6   |
| <b>Metric</b>                    |                       |             |               |       |       |       |       |       |       |       |       |                    |                  |             |           |
| Metric Description               | UPC #                 | CH & S mm   | Dia. Range    | G     | H     | L     | L1    | L2    | P     | T     | T1    | Knurl Wheel Series | Knurl Arm Set ** |             | Set Screw |
| <b>100mm Max. Diameter Range</b> |                       |             |               |       |       |       |       |       |       |       |       |                    |                  |             |           |
| KTW109-25-40-4                   | <a href="#">22871</a> | 25          | 16-100mm      | 55.2  | 161.2 | 250.8 | 127.0 | 123.8 | 1.3   | 31.8  | 50.8  | SW4*               | W109-3-40-4      | W109-3-40-O | M5-.8x6   |
| KTW109-32-40-4                   | <a href="#">22872</a> | 32          | ***           | 48.9  | 161.2 | 250.8 | 127.0 | 123.8 | 1.3   | 31.8  | 50.8  | SW4*               | W109-3-40-4      | W109-3-40-O | M5-.8x6   |

\* Supplied with one (1) set of beveled diagonal high speed TiN coated knurl wheels for a male diamond pattern, 25 TPI (1.00mm)

\*\* See Page H-54 for optional arms and specifications

\*\*\*Warning: Physically applying a knurl on small diameters may not be possible

# Diametral Forming Knurling Tools

## CNC109-M Side Mount Flange Style Square Shank Knurling Tool



- Precision square shank with preset center height is offset to the side of the tool to allow for better indexing clearance on CNC Machines
- Adjustable heavy duty arms for precise workpiece diameter setting
- Can be reversed for right or left hand operation
- Knurl wheels are mounted between thrust washers to ensure a smooth and even rotation of the knurls
- Twin knurl wheels for straight or diamond pattern



## Resulting Knurl Pattern

Straight pattern with straight wheels



Straight

Male 60° diamond pattern with diagonal wheels



Left

Right

## Recommended Use:

For best results, use beveled knurl wheels. In-feed the knurling tool into the blank until the right pattern is generated, then end-feed.

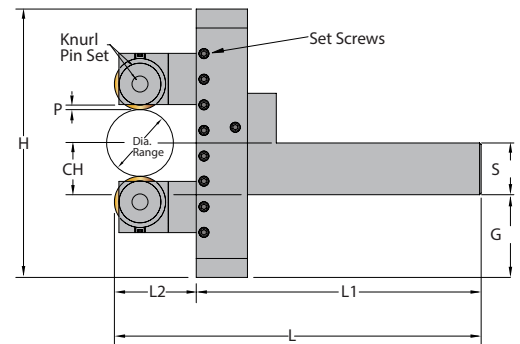
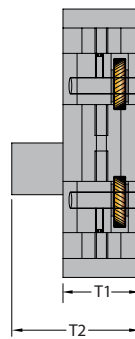
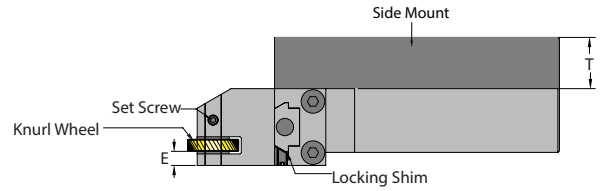

| Inch Description                | UPC #                 |                       | CH & S inch | Dia. Range     | E     | G     | H     | L     | L1    | L2    | P     | T     | T1    | T2    | Knurl Wheel Series | Knurl Arm Set ** |             | Set Screw |
|---------------------------------|-----------------------|-----------------------|-------------|----------------|-------|-------|-------|-------|-------|-------|-------|-------|-------|-------|--------------------|------------------|-------------|-----------|
|                                 | R.H.                  | L.H.                  |             |                |       |       |       |       |       |       |       |       |       |       |                    | Supplied         | Optional    |           |
| <b>1.5" Max. Diameter Range</b> |                       |                       |             |                |       |       |       |       |       |       |       |       |       |       |                    |                  |             |           |
| CNC109-75-15-M-R/L              | <a href="#">21449</a> | <a href="#">21452</a> | 0.750       | 0-1.50" ***    | 0.250 | 1.250 | 4.000 | 6.062 | 4.250 | 1.812 | 0.188 | 1.000 | 1.500 | 2.500 | M*                 | W109-3-25-M      | W109-3-25-4 | M5-.8x5   |
| CNC109-100-15-M-R/L             | <a href="#">21450</a> | <a href="#">21453</a> | 1.000       |                | 0.250 | 1.000 | 4.000 | 6.812 | 5.000 | 1.812 | 0.188 | 1.000 | 1.500 | 2.500 | M*                 | W109-3-25-M      | W109-3-25-4 | M5-.8x5   |
| CNC109-125-15-M-R/L             | <a href="#">21451</a> | <a href="#">21454</a> | 1.250       |                | 0.250 | 0.750 | 4.000 | 6.812 | 5.000 | 1.812 | 0.188 | 1.250 | 1.500 | 2.750 | M*                 | W109-3-25-M      | W109-3-25-4 | M5-.8x5   |
| <b>2.5" Max. Diameter Range</b> |                       |                       |             |                |       |       |       |       |       |       |       |       |       |       |                    |                  |             |           |
| CNC109-75-25-M-R/L              | <a href="#">21461</a> | <a href="#">21464</a> | 0.750       | .125-2.50" *** | 0.250 | 1.688 | 4.875 | 6.062 | 4.250 | 1.812 | 0.188 | 1.000 | 1.500 | 2.500 | M*                 | W109-3-25-M      | W109-3-25-4 | M5-.8x5   |
| CNC109-100-25-M-R/L             | <a href="#">21462</a> | <a href="#">21465</a> | 1.000       |                | 0.250 | 1.437 | 4.875 | 6.812 | 5.000 | 1.812 | 0.188 | 1.000 | 1.500 | 2.500 | M*                 | W109-3-25-M      | W109-3-25-4 | M5-.8x5   |
| CNC109-125-25-M-R/L             | <a href="#">21463</a> | <a href="#">21466</a> | 1.250       |                | 0.250 | 1.188 | 4.875 | 6.812 | 5.000 | 1.812 | 0.188 | 1.250 | 1.500 | 2.750 | M*                 | W109-3-25-M      | W109-3-25-4 | M5-.8x5   |
| Metric Description              | UPC #                 |                       | CH & S mm   | Dia. Range     | E     | G     | H     | L     | L1    | L2    | P     | T     | T1    | T2    | Knurl Wheel Series | Knurl Arm Set ** |             | Set Screw |
|                                 | R.H.                  | L.H.                  |             |                |       |       |       |       |       |       |       |       |       |       |                    | Supplied         | Optional    |           |
| <b>38mm Max. Diameter Range</b> |                       |                       |             |                |       |       |       |       |       |       |       |       |       |       |                    |                  |             |           |
| CNC109-20-15-M-R/L              | <a href="#">21443</a> | <a href="#">21446</a> | 20          | 0-38mm***      | 6.4   | 31.8  | 101.6 | 154.0 | 108.0 | 46.0  | 4.8   | 25.4  | 38.1  | 63.5  | M*                 | W109-3-25-M      | W109-3-25-4 | M5-.8x5   |
| CNC109-25-15-M-R/L              | <a href="#">21444</a> | <a href="#">21447</a> | 25          |                | 6.4   | 25.4  | 101.6 | 173.0 | 127.0 | 46.0  | 4.8   | 25.4  | 38.1  | 63.5  | M*                 | W109-3-25-M      | W109-3-25-4 | M5-.8x5   |
| CNC109-32-15-M-R/L              | <a href="#">21445</a> | <a href="#">21448</a> | 32          |                | 6.4   | 19.1  | 101.6 | 173.0 | 127.0 | 46.0  | 4.8   | 31.8  | 38.1  | 69.9  | M*                 | W109-3-25-M      | W109-3-25-4 | M5-.8x5   |
| <b>63mm Max. Diameter Range</b> |                       |                       |             |                |       |       |       |       |       |       |       |       |       |       |                    |                  |             |           |
| CNC109-20-25-M-R/L              | <a href="#">21455</a> | <a href="#">21458</a> | 20          | 32-63.5mm***   | 6.4   | 42.9  | 123.8 | 154.0 | 108.0 | 46.0  | 4.8   | 25.4  | 38.1  | 63.5  | M*                 | W109-3-25-M      | W109-3-25-4 | M5-.8x5   |
| CNC109-25-25-M-R/L              | <a href="#">21456</a> | <a href="#">21459</a> | 25          |                | 6.4   | 36.5  | 123.8 | 173.0 | 127.0 | 46.0  | 4.8   | 25.4  | 38.1  | 63.5  | M*                 | W109-3-25-M      | W109-3-25-4 | M5-.8x5   |
| CNC109-32-25-M-R/L              | <a href="#">21457</a> | <a href="#">21460</a> | 32          |                | 6.4   | 30.2  | 123.8 | 173.0 | 127.0 | 46.0  | 4.8   | 31.8  | 38.1  | 69.9  | M*                 | W109-3-25-M      | W109-3-25-4 | M5-.8x5   |

\* Supplied with one (1) set of beveled diagonal high speed TiN coated knurl wheels, 25 TPI (1.00mm)

\* See Page H-54 for optional arms and specifications

\*\*\* Warning: This tool has the capability to adjust the wheels until they touch, but physically applying a knurl on small diameters may not be possible

**CNC109-4 Side Mount Shoulder Style Square Shank Knurling Tool**



- Precision square shank with preset center height is offset to the side of the tool to allow for better indexing clearance on CNC Machines
- Adjustable heavy duty arms for precise workpiece diameter setting
- Can be reversed for right or left hand operation
- Knurl wheels are mounted between thrust washers to ensure a smooth and even rotation of the knurls
- Twin knurl wheels for straight or diamond pattern to a shoulder

**Resulting Knurl Pattern**



**Recommended Use:**

For best results, use beveled knurl wheels. In-feed the knurling tool into the blank until the right pattern is generated, then end-feed.



1.5" & 2.5"  
(38,1mm & 63,5mm)  
Diameter Range

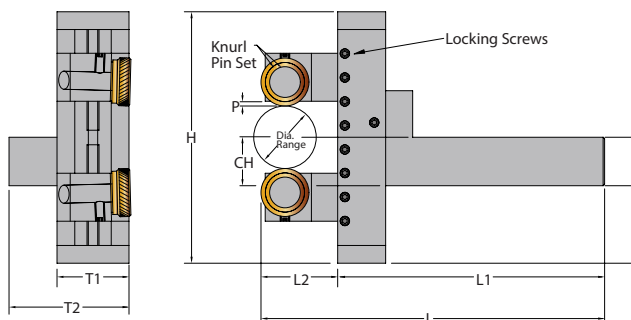
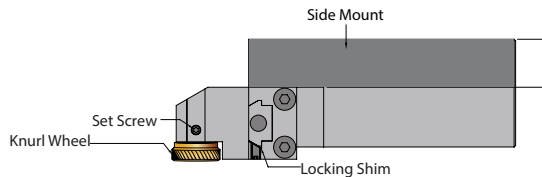

| Inch Description                | UPC #                 |                       | CH & S inch | Dia. Range     | G     | H     | L     | L1    | L2    | P     | T     | T1    | T2    | Knurl Wheel Series | Knurl Arm Set ** |             | Set Screw |
|---------------------------------|-----------------------|-----------------------|-------------|----------------|-------|-------|-------|-------|-------|-------|-------|-------|-------|--------------------|------------------|-------------|-----------|
|                                 | R.H.                  | L.H.                  |             |                |       |       |       |       |       |       |       |       |       |                    | Supplied         | Optional    |           |
| <b>1.5" Max. Diameter Range</b> |                       |                       |             |                |       |       |       |       |       |       |       |       |       |                    |                  |             |           |
| CNC109-75-15-4-R/L              | <a href="#">21473</a> | <a href="#">21476</a> | 0.750       | 0-1.50" ***    | 1.250 | 4.000 | 6.062 | 4.250 | 1.812 | 0.050 | 1.000 | 1.500 | 2.500 | SW4*               | W109-3-25-4      | W109-3-25-M | M5-.8x5   |
| CNC109-100-15-4-R/L             | <a href="#">21474</a> | <a href="#">21477</a> | 1.000       |                | 1.000 | 4.000 | 6.812 | 5.000 | 1.812 | 0.050 | 1.000 | 1.500 | 2.500 | SW4*               | W109-3-25-4      | W109-3-25-M | M5-.8x5   |
| CNC109-125-15-4-R/L             | <a href="#">21475</a> | <a href="#">21478</a> | 1.250       |                | 0.750 | 4.000 | 6.812 | 5.000 | 1.812 | 0.050 | 1.250 | 1.500 | 2.750 | SW4*               | W109-3-25-4      | W109-3-25-M | M5-.8x5   |
| <b>2.5" Max. Diameter Range</b> |                       |                       |             |                |       |       |       |       |       |       |       |       |       |                    |                  |             |           |
| CNC109-75-25-4-R/L              | <a href="#">21485</a> | <a href="#">21488</a> | 0.750       | .125-2.50" *** | 1.688 | 4.875 | 6.062 | 4.250 | 1.812 | 0.050 | 1.00  | 1.500 | 2.50  | SW4*               | W109-3-25-4      | W109-3-25-M | M5-.8x5   |
| CNC109-100-25-4-R/L             | <a href="#">21486</a> | <a href="#">21489</a> | 1.000       |                | 1.437 | 4.875 | 6.812 | 5.000 | 1.812 | 0.050 | 1.00  | 1.500 | 2.50  | SW4*               | W109-3-25-4      | W109-3-25-M | M5-.8x5   |
| CNC109-125-25-4-R/L             | <a href="#">21487</a> | <a href="#">21490</a> | 1.250       |                | 1.188 | 4.875 | 6.812 | 5.000 | 1.812 | 0.050 | 1.25  | 1.500 | 2.75  | SW4*               | W109-3-25-4      | W109-3-25-M | M5-.8x5   |
| <b>Metric</b>                   |                       |                       |             |                |       |       |       |       |       |       |       |       |       |                    |                  |             |           |
| Metric Description              | UPC #                 |                       | CH & S mm   | Dia. Range     | G     | H     | L     | L1    | L2    | P     | T     | T1    | T2    | Knurl Wheel Series | Knurl Arm Set ** |             | Set Screw |
|                                 | R.H.                  | L.H.                  |             |                |       |       |       |       |       |       |       |       |       |                    | Supplied         | Optional    |           |
| <b>38mm Max. Diameter Range</b> |                       |                       |             |                |       |       |       |       |       |       |       |       |       |                    |                  |             |           |
| CNC109-20-15-4-R/L              | <a href="#">21467</a> | <a href="#">21470</a> | 20          | 0-38mm***      | 31.8  | 101.6 | 154.0 | 108.0 | 46.0  | 1.3   | 25.4  | 38.1  | 63.5  | SW4*               | W109-3-25-4      | W109-3-25-M | M5-.8x5   |
| CNC109-25-15-4-R/L              | <a href="#">21468</a> | <a href="#">21471</a> | 25          |                | 25.4  | 101.6 | 173.0 | 127.0 | 46.0  | 1.3   | 25.4  | 38.1  | 63.5  | SW4*               | W109-3-25-4      | W109-3-25-M | M5-.8x5   |
| CNC109-32-15-4-R/L              | <a href="#">21469</a> | <a href="#">21472</a> | 32          |                | 19.1  | 101.6 | 173.0 | 127.0 | 46.0  | 1.3   | 31.8  | 38.1  | 69.9  | SW4*               | W109-3-25-4      | W109-3-25-M | M5-.8x5   |
| <b>63mm Max. Diameter Range</b> |                       |                       |             |                |       |       |       |       |       |       |       |       |       |                    |                  |             |           |
| CNC109-20-25-4-R/L              | <a href="#">21479</a> | <a href="#">21482</a> | 20          | 32-63.5mm***   | 42.9  | 123.8 | 154.0 | 108.0 | 46.0  | 1.3   | 25.4  | 38.1  | 63.5  | SW4*               | W109-3-25-4      | W109-3-25-M | M5-.8x5   |
| CNC109-25-25-4-R/L              | <a href="#">21480</a> | <a href="#">21483</a> | 25          |                | 36.5  | 123.8 | 173.0 | 127.0 | 46.0  | 1.3   | 25.4  | 38.1  | 63.5  | SW4*               | W109-3-25-4      | W109-3-25-M | M5-.8x5   |
| CNC109-32-25-4-R/L              | <a href="#">21481</a> | <a href="#">21484</a> | 32          |                | 30.2  | 123.8 | 173.0 | 127.0 | 46.0  | 1.3   | 31.8  | 38.1  | 69.9  | SW4*               | W109-3-25-4      | W109-3-25-M | M5-.8x5   |

\* Supplied with one (1) set of beveled diagonal high speed TIN coated knurl wheels, 25 TPI (1.00mm)

\*\* See Page H-54 for optional arms and specifications

\*\*\* Warning: This tool has the capability to adjust the wheels until they touch, but physically applying a knurl on small diameters may not be possible

**Interchangeable W109 Arms Sets for 1.50" - 2.50" Diameter Capacity Tools**

| Heavy Duty Style Set |                       |                    |               |                       |                |  |
|----------------------|-----------------------|--------------------|---------------|-----------------------|----------------|---|
| Description          | UPC #                 | Knurl Wheel Series | Knurl Pin Set | UPC #                 | All Set Screws |   |
| W109-3-25-M          | <a href="#">22848</a> | M*                 | KPS-31-100    | <a href="#">28845</a> | M5-.8          |   |

\* Knurl wheels sold separately

| Shoulder Style Set |                       |                    |              |                       |                |  |
|--------------------|-----------------------|--------------------|--------------|-----------------------|----------------|---|
| Description        | UPC #                 | Knurl Wheel Series | Knurl PinSet | UPC #                 | All Set Screws |   |
| W109-3-25-4        | <a href="#">22849</a> | SW4*               | SW4.0P-2S    | <a href="#">29085</a> | M5-.8          |   |

\* Knurl wheels sold separately

| Heavy Duty Style Set |                       |                    |               |                       |                |  |
|----------------------|-----------------------|--------------------|---------------|-----------------------|----------------|---|
| Description          | UPC #                 | Knurl Wheel Series | Knurl Pin Set | UPC #                 | All Set Screws |   |
| W109-3-40-O          | <a href="#">22855</a> | O*                 | KPS-31-125    | <a href="#">28850</a> | M5-.8          |   |

\* Knurl wheels sold separately

| Shoulder Style Set |                       |                    |              |                       |                |  |
|--------------------|-----------------------|--------------------|--------------|-----------------------|----------------|---|
| Description        | UPC #                 | Knurl Wheel Series | Knurl PinSet | UPC #                 | All Set Screws |   |
| W109-3-40-4        | <a href="#">22856</a> | SW4*               | SW4.0P-2S    | <a href="#">29085</a> | M5-.8          |   |

\* Knurl wheels sold separately

# Infinite Lengths



 **Three Wheel**

 **Knurling Tool**

 **DORIAN  
TOOL**

# Three Wheel Knurling Tool

Infinite Lengths with Diameters Small as .085" (2,16mm) to 1.500"

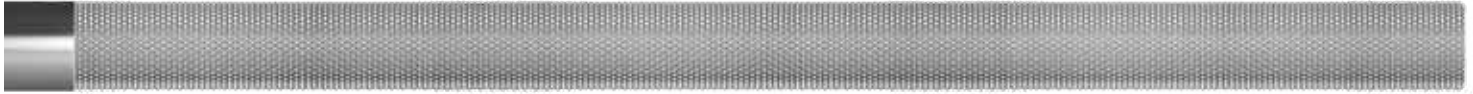

**3-Wheel Knurling Tool  
Heavy Duty Shoulderless**



**3-Wheel Knurling Tool  
to the Shoulder**

## Three wheel knurling tool properties

### 1. For small diameters

When side pressure does not allow the use of a one or two wheel knurling tool.

### 2. For long lengths

When support or live center is not permissible. The part would deflect if a standard one or two wheel knurling tool is used.

### 3. For high precision knurling

When the finished diameter of the knurled part demands close tolerance. The three wheel knurling system applies less pressure per wheel controlling the displacement and the form of the material. This makes the knurl uniform and precise.

### 4. For high production

When high performance and quality need not sacrifice high production.

### 5. For automation

When cost is a factor. The high performance of this tool will keep the manufacturing cost lower.

### 6. Which machine to use on

Automatic Screw Machines, CNC Lathes, and Turret Lathes.

## Three wheel knurling tool Features:

- Minimum diameter .085" (2,16mm)
- Maximum diameter 1.500" (38,1mm)
- For straight or diamond knurl
- Infinite lengths
- Precise scroll gear
- Fine diameter adjustment
- Dial allows for visual diameter adjustment
- Knurl to a shoulder
- Self-adjust to parts and tool misalignment
- Easy to setup
- Simple to operate
- Manual knurl diameter release for manual lathes

## 3WSKT -Three wheel knurling tool with optional round or square shanks

- Made of heat treated precision ground alloy steel.
- The dovetail guide and adjustable arms insure the most possible accuracy and rigidity.
- A precise scroll gear allows for fine diameter settings.
- Scaled dial makes setting the diameter easy.
- This tool is engineered for most required knurling jobs in Screw Machine, C.N.C. Lathe, and Turret Lathe Applications.
- Square shank can be reversed for right hand or left hand operation.
- Square shank with preset center height.

## Resulting Knurl Pattern

**Straight pattern**  
with 3 straight  
wheels



**Male 60° diamond pattern**  
with diagonal wheels  
(2 DR - 1 DL or 1 DR - 2 DL)



## Recommended Use:

For best results, use beveled knurl wheels. End-feed the knurling tool into the blank until the desired length of the knurl is done.

The Three Wheel Knurling Tool can knurl up to a shoulder, minimum diameter of .085" (2,16mm) up to 1.500" (38,1mm) diameter, and infinite lengths. The Heavy Duty Three Wheel Knurling Tool is recommended for shoulderless applications for improved wheel life. For Screw Machine, C.N.C. Lathe, and Turret Lathe Applications.

### 3 Wheel Knurling Tool Head to the Shoulder

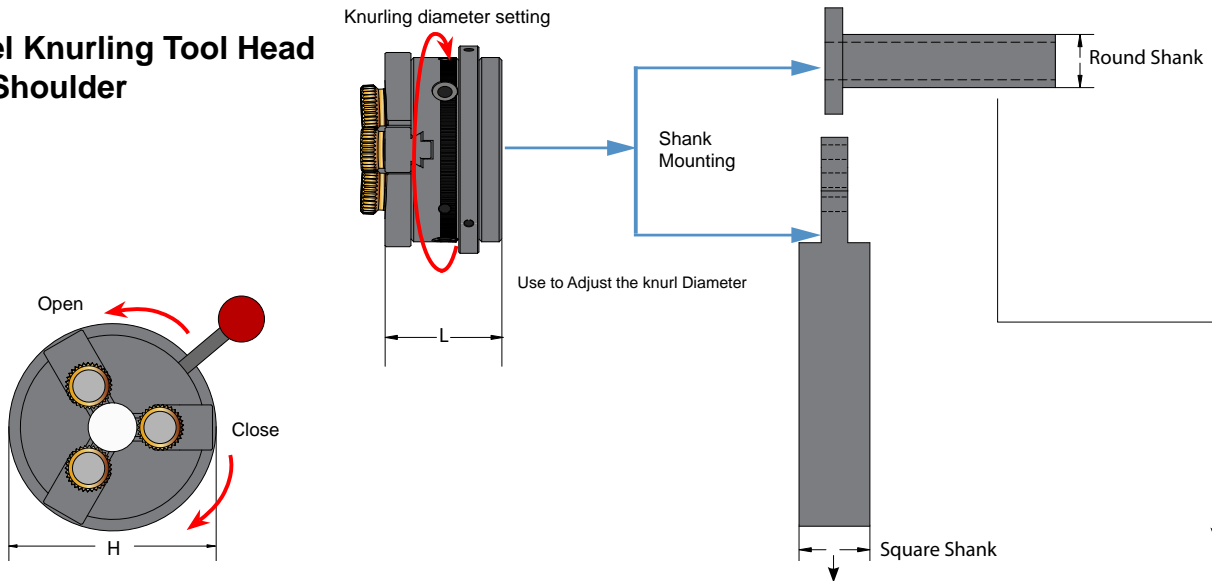

| 3 Wheels Knurling Tool Head Specification |                       |                                       |                    |                    |                    |               |                       |
|---|-----------------------|---------------------------------------|--------------------|--------------------|--------------------|---------------|-----------------------|
| Description                               | UPC #                 | Max. Capacity                         | H Body             | L Width            | Knurl Wheel Series | Knurl Pin Set | UPC #                 |
| 3WKT-06-2                                 | <a href="#">23004</a> | 2.16mm to 6.4mm<br>(.085" to 0.250")  | 44.5mm<br>(1.750") | 40.0mm<br>(1.575") | SW2 *              | SW2.0P-3S     | <a href="#">29060</a> |
| 3WKT-12-2                                 | <a href="#">23009</a> | 2.16mm to 12.7mm<br>(.085" to 0.500") | 57.2mm<br>(2.250") | 40.0mm<br>(1.575") | SW2 *              | SW2.0P-3S     | <a href="#">29060</a> |
| 3WKT-25-2                                 | <a href="#">23024</a> | 3.2mm to 25.4mm<br>(0.125" to 1.000") | 76.2mm<br>(3.000") | 40.0mm<br>(1.575") | SW2 *              | SW2.0P-3S     | <a href="#">29060</a> |
| 3WKT-40-2                                 | 23034                 | 4.75mm to 38.1m<br>(.187" to 1.500")  | 108mm<br>(4.250")  | 62.0mm<br>(2.440") | SW2 *              | SW2.0P-3S     | <a href="#">29060</a> |

| Optional Square Shank |                       |            |        |
|-----------------------|-----------------------|------------|--------|
| Description           | UPC #                 | Shank Size |        |
|                       |                       | Square     | Length |
| 3WSKT-06-12           | <a href="#">23096</a> | 12mm       | 75mm   |
| 3WSKT-06-50           | <a href="#">23095</a> | .500"      | 3.00"  |
| 3WSKT-06-162          | <a href="#">23097</a> | 16mm       | 88mm   |
|                       |                       | .625"      | 3.50"  |
| 3WSKT-06-20           | <a href="#">23098</a> | 20mm       | 100mm  |
| 3WSKT-06-75           | <a href="#">23099</a> | .750"      | 4.00"  |
| 3WSKT-12-162          | <a href="#">23082</a> | 16mm       | 88mm   |
|                       |                       | .625"      | 3.50"  |
| 3WSKT-12-20           | <a href="#">23100</a> | 20mm       | 100mm  |
| 3WSKT-12-75           | <a href="#">23102</a> | .750"      | 4.00"  |
| 3WSKT-12-25           | <a href="#">23101</a> | 25mm       | 125mm  |
| 3WSKT-12-100          | <a href="#">23078</a> | 1.00"      | 5.00"  |
| 3WSKT-25-20           | <a href="#">23103</a> | 20mm       | 100mm  |
| 3WSKT-25-75           | <a href="#">23079</a> | .750"      | 4.00"  |
| 3WSKT-25-25           | <a href="#">23104</a> | 25mm       | 125mm  |
| 3WSKT-25-100          | <a href="#">23080</a> | 1.00"      | 5.00"  |
| 3WSKT-40-25           | 23113                 | 25mm       | 125mm  |
| 3WSKT-40-100          | <a href="#">23081</a> | 1.00"      | 5.00"  |

| Optional Round Shank |                       |            |        |
|----------------------|-----------------------|------------|--------|
| Description          | UPC #                 | Shank Size |        |
|                      |                       | Dia.       | Length |
| 3WRKT-06-12          | <a href="#">23105</a> | 12mm       | 75mm   |
| 3WRKT-06-50          | 23110                 | .500"      | 3.00"  |
| 3WRKT-06-162         | <a href="#">23106</a> | 16mm       | 88mm   |
|                      |                       | .625"      | 3.50"  |
| 3WRKT-06-20          | <a href="#">23107</a> | 20mm       | 100mm  |
| 3WRKT-06-75          | 23111                 | .750"      | 4.00"  |
| 3WRKT-12-162         | 23115                 | 16mm       | 88mm   |
|                      |                       | .625"      | 3.50"  |
| 3WRKT-12-20          | 23116                 | 20mm       | 100mm  |
| 3WRKT-12-75          | 23112                 | .750"      | 4.00"  |
| 3WRKT-12-25          | 23117                 | 25mm       | 125mm  |
| 3WRKT-12-100         | 23114                 | 1.00"      | 5.00"  |
| 3WRKT-25-20          | <a href="#">23125</a> | 20mm       | 100mm  |
| 3WRKT-25-75          | <a href="#">23130</a> | .750"      | 4.00"  |
| 3WRKT-25-25          | <a href="#">23126</a> | 25mm       | 125mm  |
| 3WRKT-25-100         | <a href="#">23124</a> | 1.00"      | 5.00"  |
| 3WRKT-40-25          | <a href="#">23135</a> | 25mm       | 125mm  |
| 3WRKT-40-100         | <a href="#">23140</a> | 1.00"      | 5.00"  |

### 3-Wheel Knurling Tool Heavy Duty Shoulderless

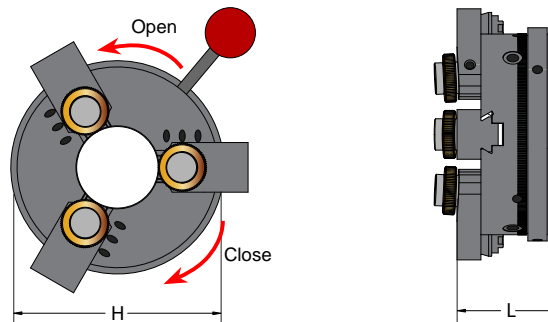

#### 3-WHEEL KNURLING TOOL HEAVY DUTY SHOULDERLESS

| 3 Wheels Knurling Tool Head Specification |                       |                                      |                   |                    |                    |               |       |
|---|-----------------------|--------------------------------------|-------------------|--------------------|--------------------|---------------|-------|
| Description                               | UPC #                 | Capacity                             | H                 | L                  | Knurl Wheel Series | Knurl Pin Set | UPC # |
| 3WKT-40-M                                 | <a href="#">23033</a> | 4.75mm to 38.1m<br>(.187" to 1.500") | 108mm<br>(4.250") | 67.2mm<br>(2.645") | M**                | SM4.0P-3S     | 29092 |

| Optional Square Shank |                       |            |        |
|-----------------------|-----------------------|------------|--------|
| Description           | UPC #                 | Shank Size |        |
|                       |                       | Square     | Length |
| 3WSKT-40-25           | 23113                 | 25mm       | 125mm  |
| 3WSKT-40-100          | <a href="#">23081</a> | 1.00"      | 5.00"  |

| Optional Round Shank |                       |            |        |
|----------------------|-----------------------|------------|--------|
| Description          | UPC #                 | Shank Size |        |
|                      |                       | Square     | Length |
| 3WRKT-40-25          | <a href="#">23135</a> | 25mm       | 125mm  |
| 3WRKT-40-100         | <a href="#">23140</a> | 1.00"      | 5.00"  |

Knurl Tool Head and Optional Shanks are Sold Separately

\* Supplied with one (1) set of two (2) diagonal right and one (1) diagonal left beveled high speed TiN coated knurl wheels, 30 TPI (0.8mm)

\*\* Supplied with one (1) set of two (2) diagonal right and one (1) diagonal left beveled high speed TiN coated knurl wheels, 25 TPI (1.0mm)

\*\*\* One (1) set consists of three (3) knurling pins and washers

## Circular Pitch Inch and Metric

| Knurl Pattern       | Coarse |       |       |       |       | Medium |       |       | Fine  |       |       |       |     |
|---------------------|--------|-------|-------|-------|-------|--------|-------|-------|-------|-------|-------|-------|-----|
|                     | TPI    | 8     | 10    | 12    | 14    | 16     | 20    | 25    | 30    | 35    | 40    | 50    | 80  |
| Tooth Angle         | 90°    | 90°   | 90°   | 90°   | 90°   | 90°    | 90°   | 90°   | 90°   | 90°   | 90°   | 70°   | 70° |
| Circular Pitch Inch | 0.125  | 0.100 | 0.083 | 0.071 | 0.063 | 0.050  | 0.040 | 0.033 | 0.029 | 0.025 | 0.020 | 0.013 |     |
| Circular Pitch mm   | 3.2    | 2.5   | 2.0   | 1.8   | 1.6   | 1.2    | 1.0   | 0.8   | 0.7   | 0.6   | 0.5   | 0.3   |     |

## Diametral Pitch

|                            |     |     |     |     |
|----------------------------|-----|-----|-----|-----|
| DP                         | 64  | 96  | 128 | 160 |
| Tooth Angle $\alpha^\circ$ | 80° | 80° | 80° | 80° |

- **TPI system** is the number of teeth per inch (measured on a linear inch).
- **Circular pitch Inch system** is the distance from tooth to tooth, or is derived from 1" divided by the number of teeth per inch.

- **Circular pitch metric system** is the distance from tooth to tooth in mm.
- **Diametral pitch system** is derived by the number of teeth per inch on the work divided by the theoretical work blank diameter.

## Knurling Wheel Identification

**Knurl Pattern**

|                       |                              |                             |                           |                             |
|-----------------------|------------------------------|-----------------------------|---------------------------|-----------------------------|
| <b>S-</b><br>Straight | <b>DR-</b><br>Diagonal Right | <b>DL-</b><br>Diagonal Left | <b>M-</b><br>Male Diamond | <b>F-</b><br>Female Diamond |
|-----------------------|------------------------------|-----------------------------|---------------------------|-----------------------------|

**TPI**

TPI is the number of teeth per inch.

Circular Pitch is the distance between tooth to tooth

**Edge Prep**

**Full Faced F**

**Beveled Edge B**

**D** - **DL** - **25** or **96** - **2** - **C** **B**

**Knurl Wheel Series**

|             | A    | B     | C     | D     | M     | O     | P    | R    | S    | SW2  | SW4  |
|-------------|------|-------|-------|-------|-------|-------|------|------|------|------|------|
| <b>DIA.</b> | .750 | .3125 | .500  | .500  | 1.00  | 1.00  | 1.25 | .750 | .750 | .500 | 1.00 |
| <b>THK.</b> | .375 | .1562 | .1875 | .1562 | .236  | .375  | .500 | .197 | .250 | .250 | .375 |
| <b>HOLE</b> | .250 | .125  | .1875 | .1875 | .3125 | .3125 | .500 | .250 | .250 | .250 | .500 |

**Material**

**C - Cobalt (TiN Coated)**

**HS - High Speed (TiN Coated)**

Knurling Wheel Tooth Pattern & Workpiece Knurl Pattern

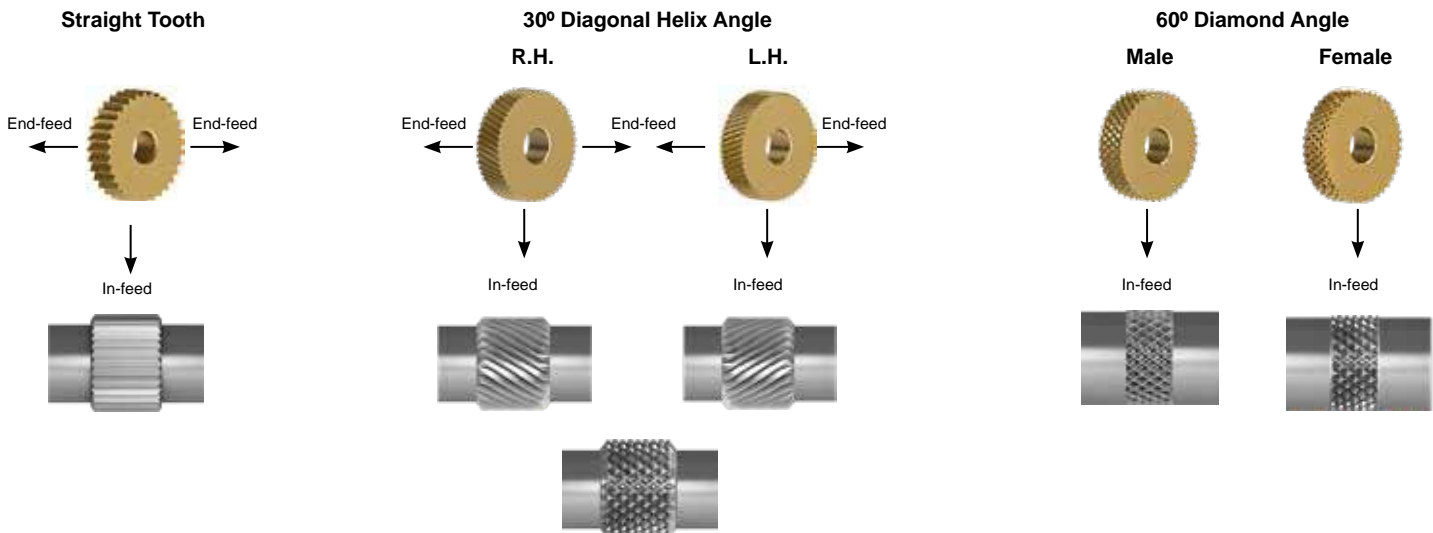

**Knurl Wheel Technology**

Dorian knurl wheels are engineered and manufactured with the highest Quality Standards and precise workmanship, to meet and exceed industry requirements in working performance and tool life expectancy.

All knurl wheels are available in High Speed Tool Steel or 8.5% Cobalt content Tool Steel.



Every knurl wheel is individually hob cut, heat-treated, and ground to precise tolerance. The teeth are lapped to a smooth surface finish in order to create a hard and precise tooth.



The knurl wheels are TiN coated to improve the working performance and generate a smooth and clean surface of the knurled part.

**Knurl Wheel Material**

**High Speed Wheels:**

The high speed tool steel knurl wheels are tough and shock resistant.

**First Choice:** to knurl hard to machine materials such as Carbon Steel, Alloy Steel, and Stainless Steel.

**Cobalt Wheels:**

The 8.5% cobalt content adds hardness and wear resistance to the wheels.

**First Choice:** to knurl abrasive and soft materials such as Free Machining Steel, Aluminum, and nonferrous materials

**Knurl Wheel Edge Prep**

For knurl cutting, use full faced knurl wheels only.

For end-feed form knurling, use beveled knurl wheels only.

For in-feed form knurling, beveled or full faced may be used.

**Knurl Forming (plunge) Versus Knurl Cutting**

**Knurl Forming**

The force applied through knurl forming is increased with harder materials, larger knurled diameter parts and larger knurl pitch, making knurling slow and difficult. The excessive pressure applied in form knurling may damage the spindle of the machine.

**First Choice:**

- Small diameter parts under 1" or 25 mm
- Larger diameters of soft material as Aluminum and low Carbon Steel
- When high surface finished is required
- When high precision knurl pitch is required
- Knurling to square shoulder
- Band in center of the part
- Manual Lathe

**Knurl Cutting**

The force applied through knurl cutting versus knurl forming is decreased to the same level of a turning operation because the knurl wheels cut instead of forming the blank, making knurling faster and easier, with no damage to the spindle of the machine.

**First Choice;**

- Diameter parts over 1/2" or 12 mm
- Larger diameters of any material
- When high surface finish is not required
- When high precision knurl pitch is not required
- Knurling to open diameter
- Cosmetic Knurling
- High production
- CNC Turning Center

**SFM Knurling**

**SFM Knurl Forming**

For speed and feed, see Page H-16.

**SFM Knurl Cutting**

For speed and feed, See Page H-16.

# Knurl Wheels

## A Series

For knurl cutting, use full faced knurl wheels only.

For end-feed form knurling, use beveled knurl wheels only.

For in-feed form knurling, beveled or full faced may be used.

Knurl wheels can be reversed for right or left hand operation.

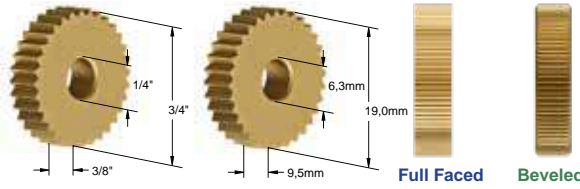

Knurl wheels are TiN coated to reduce the coefficient of friction when knurling, increasing the quality and the force of knurling as well as the life of the knurl wheels.

| Circular Knurl Pitch |        | Included Tooth Angle | Knurl Pattern | A Series Knurl Wheel                                  | Straight                   |                           | Diagonal Right              |                            | Diagonal Left               |                            | Diamond                    |                              |
|----------------------|--------|----------------------|---------------|---|----------------------------|---------------------------|-----------------------------|----------------------------|-----------------------------|----------------------------|----------------------------|------------------------------|
| Inch                 | Metric |                      |               |   | High Speed TiN Coated      | Cobalt TiN Coated         | High Speed TiN Coated       | Cobalt TiN Coated          | High Speed TiN Coated       | Cobalt TiN Coated          | Male High Speed TiN Coated | Female High Speed TiN Coated |
| 08 (TPI)             | 3,2mm  | 90°                  | Coarse        | Description<br>Tracking Data<br>Full Faced<br>Beveled | AS-08-HS<br>19T / .0400"   | AS-08-C<br>19T / .0400"   | ADR-08-HS<br>16T / .0475"   | ADR-08-C<br>16T / .0475"   | ADL-08-HS<br>16T / .0475"   | ADL-08-C<br>16T / .0475"   | AM-08-HS<br>16T / .0475"   | AF-08-HS<br>16T / .0475"     |
| 10 (TPI)             | 2,5mm  | 90°                  |               | Description<br>Tracking Data<br>Full Faced<br>Beveled | AS-10-HS<br>23T / .0330"   | AS-10-C<br>23T / .0330"   | ADR-10-HS<br>20T / .0380"   | ADR-10-C<br>20T / .0380"   | ADL-10-HS<br>20T / .0380"   | ADL-10-C<br>20T / .0380"   | AM-10-HS<br>20T / .0380"   | AF-10-HS<br>20T / .0380"     |
| 12 (TPI)             | 2,0mm  | 90°                  |               | Description<br>Tracking Data<br>Full Faced<br>Beveled | AS-12-HS<br>28T / .0271"   | AS-12-C<br>28T / .0271"   | ADR-12-HS<br>25T / .0304"   | ADR-12-C<br>25T / .0304"   | ADL-12-HS<br>25T / .0304"   | ADL-12-C<br>25T / .0304"   | AM-12-HS<br>25T / .0304"   | AF-12-HS<br>25T / .0304"     |
| 14 (TPI)             | 1,8mm  | 90°                  |               | Description<br>Tracking Data<br>Full Faced<br>Beveled | AS-14-HS<br>34T / .0224"   | AS-14-C<br>34T / .0224"   | ADR-14-HS<br>34T / .0224"   | ADR-14-C<br>34T / .0224"   | ADL-14-HS<br>34T / .0224"   | ADL-14-C<br>34T / .0224"   | AM-14-HS<br>34T / .0224"   | AF-14-HS<br>34T / .0224"     |
| 16 (TPI)             | 1,6mm  | 90°                  |               | Description<br>Tracking Data<br>Full Faced<br>Beveled | AS-16-HS<br>38T / .0200"   | AS-16-C<br>38T / .0200"   | ADR-16-HS<br>33T / .0230"   | ADR-16-C<br>33T / .0230"   | ADL-16-HS<br>33T / .0230"   | ADL-16-C<br>33T / .0230"   | AM-16-HS<br>33T / .0230"   | AF-16-HS<br>33T / .0230"     |
| 20 (TPI)             | 1,2mm  | 90°                  | Medium        | Description<br>Tracking Data<br>Full Faced<br>Beveled | AS-20-HS<br>47T / .0161"   | AS-20-C<br>47T / .0161"   | ADR-20-HS<br>41T / .0185"   | ADR-20-C<br>41T / .0185"   | ADL-20-HS<br>41T / .0185"   | ADL-20-C<br>41T / .0185"   | AM-20-HS<br>41T / .0185"   | AF-20-HS<br>41T / .0185"     |
| 25 (TPI)             | 1,0mm  | 90°                  |               | Description<br>Tracking Data<br>Full Faced<br>Beveled | AS-25-HS<br>59T / .0128"   | AS-25-C<br>59T / .0128"   | ADR-25-HS<br>51T / .0148"   | ADR-25-C<br>51T / .0148"   | ADL-25-HS<br>51T / .0148"   | ADL-25-C<br>51T / .0148"   | AM-25-HS<br>51T / .0148"   | AF-25-HS<br>51T / .0148"     |
| 30 (TPI)             | 0,8mm  | 90°                  |               | Description<br>Tracking Data<br>Full Faced<br>Beveled | AS-30-HS<br>71T / .0106"   | AS-30-C<br>71T / .0106"   | ADR-30-HS<br>61T / .0124"   | ADR-30-C<br>61T / .0124"   | ADL-30-HS<br>61T / .0124"   | ADL-30-C<br>61T / .0124"   | AM-30-HS<br>61T / .0124"   | AF-30-HS<br>61T / .0124"     |
| 35 (TPI)             | 0,7mm  | 90°                  |               | Description<br>Tracking Data<br>Full Faced<br>Beveled | AS-35-HS<br>82T / .0092"   | AS-35-C<br>82T / .0092"   | ADR-35-HS<br>71T / .0106"   | ADR-35-C<br>71T / .0106"   | ADL-35-HS<br>71T / .0106"   | ADL-35-C<br>71T / .0106"   | AM-35-HS<br>71T / .0106"   | AF-35-HS<br>71T / .0106"     |
| 40 (TPI)             | 0,6mm  | 90°                  | Fine          | Description<br>Tracking Data<br>Full Faced<br>Beveled | AS-40-HS<br>94T / .0080"   | AS-40-C<br>94T / .0080"   | ADR-40-HS<br>81T / .0093"   | ADR-40-C<br>81T / .0093"   | ADL-40-HS<br>81T / .0093"   | ADL-40-C<br>81T / .0093"   | AM-40-HS<br>81T / .0093"   | AF-40-HS<br>81T / .0093"     |
| 50 (TPI)             | 0,5mm  | 70°                  |               | Description<br>Tracking Data<br>Full Faced<br>Beveled | AS-50-HS<br>117T / .0064"  | AS-50-C<br>117T / .0064"  | ADR-50-HS<br>102T / .0074"  | ADR-50-C<br>102T / .0074"  | ADL-50-HS<br>102T / .0074"  | ADL-50-C<br>102T / .0074"  | AM-50-HS<br>102T / .0074"  | AF-50-HS<br>102T / .0074"    |
| 80 (TPI)             | 0,3mm  | 70°                  |               | Description<br>Tracking Data<br>Full Faced<br>Beveled | AS-80-HS<br>189T / .0040"  | AS-80-C<br>189T / .0040"  | ADR-80-HS<br>163T / .0046"  | ADR-80-C<br>163T / .0046"  | ADL-80-HS<br>163T / .0046"  | ADL-80-C<br>163T / .0046"  | AM-80-HS<br>163T / .0046"  | AF-80-HS<br>163T / .0046"    |
| Diametral Pitch      |        |                      |               |   |                            |                           |                             |                            |                             |                            |                            |                              |
| 64                   | 1,2mm  | 80°                  | Medium        | Description<br>Tracking Data<br>Full Faced<br>Beveled | AS-64-HS<br>48T / .0156"   | AS-64-C<br>48T / .0156"   | ADR-64-HS<br>48T / .0156"   | ADR-64-C<br>48T / .0156"   | ADL-64-HS<br>48T / .0156"   | ADL-64-C<br>48T / .0156"   | AM-64-HS<br>48T / .0156"   | AF-64-HS<br>48T / .0156"     |
| 96                   | 0,8mm  | 80°                  |               | Description<br>Tracking Data<br>Full Faced<br>Beveled | AS-96-HS<br>72T / .0104"   | AS-96-C<br>72T / .0104"   | ADR-96-HS<br>72T / .0104"   | ADR-96-C<br>72T / .0104"   | ADL-96-HS<br>72T / .0104"   | ADL-96-C<br>72T / .0104"   | AM-96-HS<br>72T / .0104"   | AF-96-HS<br>72T / .0104"     |
| 128                  | 0,6mm  | 80°                  | Fine          | Description<br>Tracking Data<br>Full Faced<br>Beveled | AS-128-HS<br>96T / .0078"  | AS-128-C<br>96T / .0078"  | ADR-128-HS<br>96T / .0078"  | ADR-128-C<br>96T / .0078"  | ADL-128-HS<br>96T / .0078"  | ADL-128-C<br>96T / .0078"  | AM-128-HS<br>96T / .0078"  | AF-128-HS<br>96T / .0078"    |
| 160                  | 0,5mm  | 80°                  |               | Description<br>Tracking Data<br>Full Faced<br>Beveled | AS-160-HS<br>120T / .0063" | AS-160-C<br>120T / .0063" | ADR-160-HS<br>120T / .0063" | ADR-160-C<br>120T / .0063" | ADL-160-HS<br>120T / .0063" | ADL-160-C<br>120T / .0063" | AM-160-HS<br>120T / .0063" | AF-160-HS<br>120T / .0063"   |

**B Series**

For knurl cutting, use full faced knurl wheels only.

For end-feed form knurling, use beveled knurl wheels only.

For in-feed form knurling, beveled or full faced may be used.

Knurl wheels can be reversed for right or left hand operation.

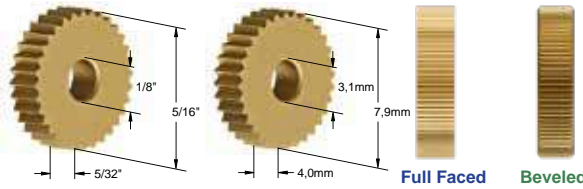

Knurl wheels are TiN coated to reduce the coefficient of friction when knurling, increasing the quality and the force of knurling as well as the life of the knurl wheels.

| Circular Knurl Pitch   |        | Included Tooth Angle | Knurl Pattern | B Series Knurl Wheel | Straight              |                   | Diagonal Right        |                   | Diagonal Left         |                   | Diamond                    |                              |              |
|------------------------|--------|----------------------|---------------|----------------------|-----------------------|-------------------|-----------------------|-------------------|-----------------------|-------------------|----------------------------|------------------------------|--------------|
| Inch                   | Metric |                      |               |                      | High Speed TiN Coated | Cobalt TiN Coated | High Speed TiN Coated | Cobalt TiN Coated | High Speed TiN Coated | Cobalt TiN Coated | Male High Speed TiN Coated | Female High Speed TiN Coated |              |
| 20 (TPI)               | 1,2mm  | 90°                  | Medium        | Description          | BS-20-HS              | BS-20-C           | BDR-20-HS             | BDR-20-C          | BDL-20-HS             | BDL-20-C          | BM-20-HS                   | BF-20-HS                     |              |
|                        |        |                      |               | Tracking Data        | 19T / .0168"          | 19T / .0168"      | 17T / .0188"          | 17T / .0188"      | 17T / .0188"          | 17T / .0188"      | 17T / .0188"               | 17T / .0188"                 |              |
|                        |        |                      |               | Full Faced           | -                     | -                 | -                     | -                 | -                     | -                 | -                          | -                            |              |
| Beveled                | -      | -                    |               | -                    | -                     | -                 | -                     | -                 | -                     |                   |                            |                              |              |
| 25 (TPI)               | 1,0mm  | 90°                  |               | Description          | BS-25-HS              | BS-25-C           | BDR-25-HS             | BDR-25-C          | BDL-25-HS             | BDL-25-C          | BM-25-HS                   | BF-25-HS                     |              |
|                        |        |                      |               | Tracking Data        | 25T / .0128"          | 25T / .0128"      | 21T / .0152"          | 21T / .0152"      | 21T / .0152"          | 21T / .0152"      | 21T / .0152"               | 21T / .0152"                 |              |
|                        |        |                      |               | Full Faced           | -                     | -                 | -                     | -                 | -                     | -                 | -                          | -                            |              |
| Beveled                | -      | -                    |               | -                    | -                     | -                 | -                     | -                 | -                     |                   |                            |                              |              |
| 30 (TPI)               | 0,8mm  | 90°                  |               | Description          | BS-30-HS              | BS-30-C           | BDR-30-HS             | BDR-30-C          | BDL-30-HS             | BDL-30-C          | BM-30-HS                   | BF-30-HS                     |              |
|                        |        |                      | Tracking Data | 29T / .0110"         | 29T / .0110"          | 26T / .0122"      | 26T / .0122"          | 26T / .0122"      | 26T / .0122"          | 26T / .0122"      | 26T / .0122"               |                              |              |
|                        |        |                      | Full Faced    | -                    | -                     | -                 | -                     | -                 | -                     | -                 | 24382                      |                              |              |
| Beveled                | 24129  | -                    | 24221         | -                    | 24313                 | -                 | -                     | -                 |                       |                   |                            |                              |              |
| 35 (TPI)               | 0,7mm  | 90°                  | Description   | BS-35-HS             | BS-35-C               | BDR-35-HS         | BDR-35-C              | BDL-35-HS         | BDL-35-C              | BM-35-HS          | BF-35-HS                   |                              |              |
|                        |        |                      | Tracking Data | 34T / .0093"         | 34T / .0093"          | 29T / .0110"      | 29T / .0110"          | 29T / .0110"      | 29T / .0110"          | 29T / .0110"      | 29T / .0110"               |                              |              |
|                        |        |                      | Full Faced    | -                    | 24154                 | 24200             | -                     | 24292             | -                     | -                 | -                          |                              |              |
| Beveled                | -      | -                    | -             | -                    | -                     | -                 | -                     | -                 |                       |                   |                            |                              |              |
| 40 (TPI)               | 0,6mm  | 90°                  | Description   | BS-40-HS             | BS-40-C               | BDR-40-HS         | BDR-40-C              | BDL-40-HS         | BDL-40-C              | BM-40-HS          | BF-40-HS                   |                              |              |
|                        |        |                      | Tracking Data | 39T / .0081"         | 39T / .0081"          | 34T / .0093"      | 34T / .0093"          | 34T / .0093"      | 34T / .0093"          | 34T / .0093"      | 34T / .0093"               |                              |              |
|                        |        |                      | Full Faced    | 24110                | 24156                 | 24202             | 24248                 | 24294             | 24340                 | -                 | -                          |                              |              |
| Beveled                | -      | -                    | -             | -                    | -                     | -                 | -                     | -                 |                       |                   |                            |                              |              |
| 50 (TPI)               | 0,5mm  | 70°                  | Description   | BS-50-HS             | BS-50-C               | BDR-50-HS         | BDR-50-C              | BDL-50-HS         | BDL-50-C              | BM-50-HS          | BF-50-HS                   |                              |              |
|                        |        |                      | Tracking Data | 49T / .0064"         | 49T / .0064"          | 43T / .0073"      | 43T / .0073"          | 43T / .0073"      | 43T / .0073"          | 43T / .0073"      | 43T / .0073"               |                              |              |
|                        |        |                      | Full Faced    | -                    | 24158                 | -                 | -                     | -                 | -                     | 24388             | -                          |                              |              |
| Beveled                | -      | -                    | -             | -                    | -                     | -                 | -                     | -                 |                       |                   |                            |                              |              |
| 80 (TPI)               | 0,3mm  | 70°                  | Description   | BS-80-HS             | BS-80-C               | BDR-80-HS         | BDR-80-C              | BDL-80-HS         | BDL-80-C              | BM-80-HS          | BF-80-HS                   |                              |              |
|                        |        |                      | Tracking Data | 79T / .0040"         | 79T / .0040"          | 68T / .0046"      | 68T / .0046"          | 68T / .0046"      | 68T / .0046"          | 68T / .0046"      | 68T / .0046"               |                              |              |
|                        |        |                      | Full Faced    | -                    | -                     | -                 | -                     | -                 | -                     | -                 | -                          |                              |              |
| Beveled                | 24137  | -                    | -             | -                    | -                     | -                 | -                     | -                 |                       |                   |                            |                              |              |
| <b>Diametral Pitch</b> |        |                      |               |                      |                       |                   |                       |                   |                       |                   |                            |                              |              |
| 96                     | 0,8mm  | 80°                  | Medium        | Description          | BS-96-HS              | BS-96-C           | BDR-96-HS             | BDR-96-C          | BDL-96-HS             | BDL-96-C          | BM-96-HS                   | BF-96-HS                     |              |
|                        |        |                      |               | Tracking Data        | 30T / .0104"          | 30T / .0104"      | 30T / .0104"          | 30T / .0104"      | 30T / .0104"          | 30T / .0104"      | 30T / .0104"               | 30T / .0104"                 |              |
|                        |        |                      |               | Full Faced           | 24116                 | 24162             | 24208                 | -                 | 24300                 | -                 | -                          | -                            |              |
| Beveled                | -      | -                    |               | -                    | -                     | -                 | -                     | -                 | -                     |                   |                            |                              |              |
| 128                    | 0,6mm  | 80°                  |               | Fine                 | Description           | BS-128-HS         | BS-128-C              | BDR-128-HS        | BDR-128-C             | BDL-128-HS        | BDL-128-C                  | BM-128-HS                    | BF-128-HS    |
|                        |        |                      |               |                      | Tracking Data         | 40T / .0078"      | 40T / .0078"          | 40T / .0078"      | 40T / .0078"          | 40T / .0078"      | 40T / .0078"               | 40T / .0078"                 | 40T / .0078" |
|                        |        |                      |               |                      | Full Faced            | 24118             | -                     | 24210             | -                     | 24302             | -                          | -                            | -            |
| Beveled                | -      | -                    |               |                      | -                     | -                 | -                     | -                 | -                     | -                 |                            |                              |              |
| 160                    | 0,5mm  | 80°                  |               |                      | Description           | BS-160-HS         | BS-160-C              | BDR-160-HS        | BDR-160-C             | BDL-160-HS        | BDL-160-C                  | BM-160-HS                    | BF-160-HS    |
|                        |        |                      | Tracking Data |                      | 50T / .0063"          | 50T / .0063"      | 50T / .0063"          | 50T / .0063"      | 50T / .0063"          | 50T / .0063"      | 50T / .0063"               | 50T / .0063"                 |              |
|                        |        |                      | Full Faced    |                      | 24120                 | -                 | -                     | -                 | -                     | -                 | -                          | -                            |              |
| Beveled                | -      | -                    | -             |                      | -                     | -                 | -                     | -                 | -                     |                   |                            |                              |              |

|      |                                  |
|------|----------------------------------|
| A    | Knurl wheel size                 |
| S    | Knurl wheel pattern              |
| 08   | TPI number of teeth per inches   |
| HS   | Knurl wheel material             |
| 19T  | Number of the teeth of the wheel |
| .400 | Tracking value                   |
| F    | Full face knurl wheel            |
| B    | Beveled edge knurl wheel         |

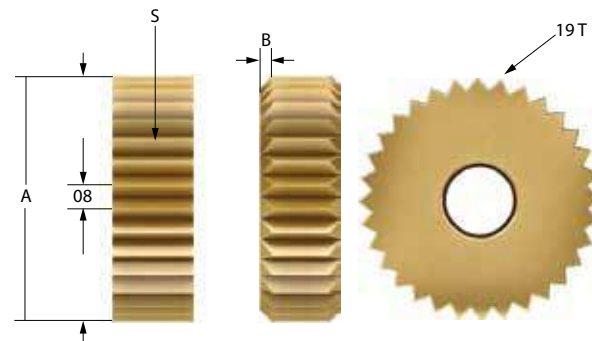

## C Series

For knurl cutting, use full faced knurl wheels only.

For end-feed form knurling, use beveled knurl wheels only.

For in-feed form knurling, beveled or full faced may be used.

Knurl wheels can be reversed for right or left hand operation.

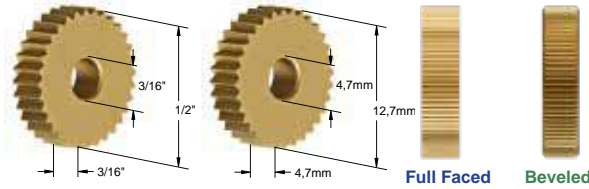

Knurl wheels are TiN coated to reduce the coefficient of friction when knurling, increasing the quality and the force of knurling as well as the life of the knurl wheels.

| Circular Knurl Pitch |        | Included Tooth Angle | Knurl Pattern | C Series Knurl Wheel | Straight              |                   | Diagonal Right        |                   | Diagonal Left         |                   | Diamond                    |                              |
|----------------------|--------|----------------------|---------------|----------------------|-----------------------|-------------------|-----------------------|-------------------|-----------------------|-------------------|----------------------------|------------------------------|
| Inch                 | Metric |                      |               |                      | High Speed TiN Coated | Cobalt TiN Coated | High Speed TiN Coated | Cobalt TiN Coated | High Speed TiN Coated | Cobalt TiN Coated | Male High Speed TiN Coated | Female High Speed TiN Coated |
| 16 (TPI)             | 1,6mm  | 90°                  | Coarse        | Description          | CS-16-HS              | CS-16-C           | CDR-16-HS             | CDR-16-C          | CDL-16-HS             | CDL-16-C          | CM-16-HS                   | CF-16-HS                     |
|                      |        |                      |               | Tracking Data        | 25T / .0204"          | 25T / .0204"      | 22T / .0232"          | 22T / .0232"      | 22T / .0232"          | 22T / .0232"      | 22T / .0232"               | 22T / .0232"                 |
|                      |        |                      |               | Full Faced           | 24502                 | -                 | 24610                 | -                 | 24718                 | -                 | -                          | -                            |
|                      |        |                      |               | Beveled              | -                     | -                 | -                     | -                 | -                     | -                 | -                          |                              |
| 20 (TPI)             | 1,2mm  | 90°                  | Medium        | Description          | CS-20-HS              | CS-20-C           | CDR-20-HS             | CDR-20-C          | CDL-20-HS             | CDL-20-C          | CM-20-HS                   | CF-20-HS                     |
|                      |        |                      |               | Tracking Data        | 31T / .0164"          | 31T / .0164"      | 27T / .0188"          | 27T / .0188"      | 27T / .0188"          | 27T / .0188"      | 27T / .0188"               | 27T / .0188"                 |
|                      |        |                      |               | Full Faced           | 24504                 | -                 | -                     | -                 | -                     | -                 | -                          | -                            |
|                      |        |                      |               | Beveled              | -                     | -                 | -                     | -                 | -                     | -                 | -                          |                              |
| 25 (TPI)             | 1,0mm  | 90°                  | Medium        | Description          | CS-25-HS              | CS-25-C           | CDR-25-HS             | CDR-25-C          | CDL-25-HS             | CDL-25-C          | CM-25-HS                   | CF-25-HS                     |
|                      |        |                      |               | Tracking Data        | 38T / .0133"          | 38T / .0133"      | 34T / .0149"          | 34T / .0149"      | 34T / .0149"          | 34T / .0149"      | 34T / .0149"               | 34T / .0149"                 |
|                      |        |                      |               | Full Faced           | 24506                 | -                 | 24614                 | 24668             | 24722                 | 24776             | -                          | 24884                        |
|                      |        |                      |               | Beveled              | -                     | -                 | 24641                 | 24749             | -                     | -                 | -                          |                              |
| 30 (TPI)             | 0,8mm  | 90°                  | Medium        | Description          | CS-30-HS              | CS-30-C           | CDR-30-HS             | CDR-30-C          | CDL-30-HS             | CDL-30-C          | CM-30-HS                   | CF-30-HS                     |
|                      |        |                      |               | Tracking Data        | 47T / .0107"          | 47T / .0107"      | 40T / .0126"          | 40T / .0126"      | 40T / .0126"          | 40T / .0126"      | 40T / .0126"               | 40T / .0126"                 |
|                      |        |                      |               | Full Faced           | 24508                 | 24562             | 24616                 | 24670             | 24724                 | 24778             | -                          | -                            |
|                      |        |                      |               | Beveled              | -                     | -                 | -                     | -                 | -                     | -                 | -                          |                              |
| 35 (TPI)             | 0,7mm  | 90°                  | Medium        | Description          | CS-35-HS              | CS-35-C           | CDR-35-HS             | CDR-35-C          | CDL-35-HS             | CDL-35-C          | CM-35-HS                   | CF-35-HS                     |
|                      |        |                      |               | Tracking Data        | 55T / .0092"          | 55T / .0092"      | 47T / .0107"          | 47T / .0107"      | 47T / .0107"          | 47T / .0107"      | 47T / .0107"               | 47T / .0107"                 |
|                      |        |                      |               | Full Faced           | 24510                 | -                 | -                     | -                 | -                     | -                 | -                          | -                            |
|                      |        |                      |               | Beveled              | -                     | -                 | -                     | -                 | -                     | -                 | -                          |                              |
| 40 (TPI)             | 0,6mm  | 90°                  | Fine          | Description          | CS-40-HS              | CS-40-C           | CDR-40-HS             | CDR-40-C          | CDL-40-HS             | CDL-40-C          | CM-40-HS                   | CF-40-HS                     |
|                      |        |                      |               | Tracking Data        | 63T / .0080"          | 63T / .0080"      | 55T / .0092"          | 55T / .0092"      | 55T / .0092"          | 55T / .0092"      | 55T / .0092"               | 55T / .0092"                 |
|                      |        |                      |               | Full Faced           | 24512                 | 24566             | -                     | 24674             | -                     | 24782             | 24836                      | -                            |
|                      |        |                      |               | Beveled              | -                     | -                 | -                     | -                 | -                     | -                 | -                          |                              |
| 50 (TPI)             | 0,5mm  | 70°                  | Fine          | Description          | CS-50-HS              | CS-50-C           | CDR-50-HS             | CDR-50-C          | CDL-50-HS             | CDL-50-C          | CM-50-HS                   | CF-50-HS                     |
|                      |        |                      |               | Tracking Data        | 79T / .0064"          | 79T / .0064"      | 68T / .0074"          | 68T / .0074"      | 68T / .0074"          | 68T / .0074"      | 68T / .0074"               | 68T / .0074"                 |
|                      |        |                      |               | Full Faced           | 24514                 | 24568             | -                     | -                 | -                     | -                 | -                          | 24892                        |
|                      |        |                      |               | Beveled              | -                     | -                 | -                     | -                 | -                     | -                 | -                          |                              |
| 80 (TPI)             | 0,3mm  | 70°                  | Fine          | Description          | CS-80-HS              | CS-80-C           | CDR-80-HS             | CDR-80-C          | CDL-80-HS             | CDL-80-C          | CM-80-HS                   | CF-80-HS                     |
|                      |        |                      |               | Tracking Data        | 125T / .0040"         | 125T / .0040"     | 107T / .0047"         | 107T / .0047"     | 107T / .0047"         | 107T / .0047"     | 107T / .0047"              | 107T / .0047"                |
|                      |        |                      |               | Full Faced           | 24516                 | 24570             | 24624                 | 24678             | 24732                 | 24786             | -                          | -                            |
|                      |        |                      |               | Beveled              | -                     | 24597             | -                     | -                 | -                     | -                 | -                          |                              |
| Diametral Pitch      |        |                      |               |                      |                       |                   |                       |                   |                       |                   |                            |                              |
| 64                   | 1,2mm  | 80°                  | Medium        | Description          | CS-64-HS              | CS-64-C           | CDR-64-HS             | CDR-64-C          | CDL-64-HS             | CDL-64-C          | CM-64-HS                   | CF-64-HS                     |
|                      |        |                      |               | Tracking Data        | 32T / .0156"          | 32T / .0156"      | 32T / .0156"          | 32T / .0156"      | 32T / .0156"          | 32T / .0156"      | 32T / .0156"               | 32T / .0156"                 |
|                      |        |                      |               | Full Faced           | -                     | -                 | 24626                 | 24680             | 24734                 | 24788             | 24842                      | -                            |
|                      |        |                      |               | Beveled              | -                     | -                 | -                     | -                 | -                     | -                 | -                          |                              |
| 96                   | 0,8mm  | 80°                  | Medium        | Description          | CS-96-HS              | CS-96-C           | CDR-96-HS             | CDR-96-C          | CDL-96-HS             | CDL-96-C          | CM-96-HS                   | CF-96-HS                     |
|                      |        |                      |               | Tracking Data        | 48T / .0104"          | 48T / .0104"      | 48T / .0104"          | 48T / .0104"      | 48T / .0104"          | 48T / .0104"      | 48T / .0104"               | 48T / .0104"                 |
|                      |        |                      |               | Full Faced           | -                     | -                 | -                     | -                 | -                     | -                 | -                          | 24898                        |
|                      |        |                      |               | Beveled              | -                     | -                 | -                     | -                 | -                     | -                 | -                          |                              |
| 128                  | 0,6mm  | 80°                  | Fine          | Description          | CS-128-HS             | CS-128-C          | CDR-128-HS            | CDR-128-C         | CDL-128-HS            | CDL-128-C         | CM-128-HS                  | CF-128-HS                    |
|                      |        |                      |               | Tracking Data        | 64T / .0078"          | 64T / .0078"      | 64T / .0078"          | 64T / .0078"      | 64T / .0078"          | 64T / .0078"      | 64T / .0078"               | 64T / .0078"                 |
|                      |        |                      |               | Full Faced           | 24522                 | -                 | -                     | -                 | -                     | -                 | -                          | -                            |
|                      |        |                      |               | Beveled              | -                     | -                 | -                     | -                 | -                     | -                 | -                          |                              |
| 160                  | 0,5mm  | 80°                  | Fine          | Description          | CS-160-HS             | CS-160-C          | CDR-160-HS            | CDR-160-C         | CDL-160-HS            | CDL-160-C         | CM-160-HS                  | CF-160-HS                    |
|                      |        |                      |               | Tracking Data        | 80T / .0063"          | 80T / .0063"      | 80T / .0063"          | 80T / .0063"      | 80T / .0063"          | 80T / .0063"      | 80T / .0063"               | 80T / .0063"                 |
|                      |        |                      |               | Full Faced           | 24524                 | 24578             | -                     | -                 | -                     | -                 | -                          | -                            |
|                      |        |                      |               | Beveled              | -                     | -                 | -                     | -                 | -                     | -                 | -                          |                              |

**D Series**

For knurl cutting, use full faced knurl wheels only.

For end-feed form knurling, use beveled knurl wheels only.

For in-feed form knurling, beveled or full faced may be used.

Knurl wheels can be reversed for right or left hand operation.

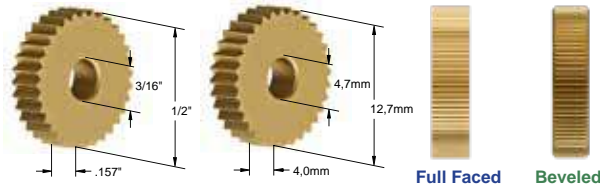

Knurl wheels are TiN coated to reduce the coefficient of friction when knurling, increasing the quality and the force of knurling as well as the life of the knurl wheels.

| Circular Knurl Pitch   |        | Included Tooth Angle | Knurl Pattern | D Series Knurl Wheel | Straight              |                   | Diagonal Right        |                   | Diagonal Left         |                   | Diamond                      |                          |
|------------------------|--------|----------------------|---------------|----------------------|-----------------------|-------------------|-----------------------|-------------------|-----------------------|-------------------|------------------------------|--------------------------|
| Inch                   | Metric |                      |               |                      | High Speed TiN Coated | Cobalt TiN Coated | High Speed TiN Coated | Cobalt TiN Coated | High Speed TiN Coated | Cobalt TiN Coated | Female High Speed TiN Coated | Female Cobalt TiN Coated |
| 16 (TPI)               | 1,6mm  | 90°                  | Coarse        | Description          | DS-16-HS              | DS-16-C           | DDR-16-HS             | DDR-16-C          | DDL-16-HS             | DDL-16-C          | DF-16-HS                     | DF-16-C                  |
|                        |        |                      |               | Tracking Data        | 25T / .0204"          | 25T / .0204"      | 22T / .0232"          | 22T / .0232"      | 22T / .0232"          | 22T / .0232"      | 22T / .0232"                 | 22T / .0232"             |
|                        |        |                      |               | Full Faced           | 25001                 | -                 | 25055                 | 25056             | 25109                 | 25110             | -                            | -                        |
|                        |        |                      | Beveled       | -                    | -                     | 25082             | 25083                 | 25136             | 25137                 | -                 | -                            |                          |
| 20 (TPI)               | 1,2mm  | 90°                  | Medium        | Description          | DS-20-HS              | DS-20-C           | DDR-20-HS             | DDR-20-C          | DDL-20-HS             | DDL-20-C          | DF-20-HS                     | DF-20-C                  |
|                        |        |                      |               | Tracking Data        | 31T / .0164"          | 31T / .0164"      | 27T / .0188"          | 27T / .0188"      | 27T / .0188"          | 27T / .0188"      | 27T / .0188"                 | 27T / .0188"             |
|                        |        |                      |               | Full Faced           | 25003                 | 25004             | 25057                 | 25058             | 25111                 | 25112             | -                            | -                        |
|                        |        |                      | Beveled       | 25030                | 25031                 | 25084             | 25085                 | 25138             | 25139                 | 25192             | -                            |                          |
| 25 (TPI)               | 1,0mm  | 90°                  | Medium        | Description          | DS-25-HS              | DS-25-C           | DDR-25-HS             | DDR-25-C          | DDL-25-HS             | DDL-25-C          | DF-25-HS                     | DF-25-C                  |
|                        |        |                      |               | Tracking Data        | 38T / .0133"          | 38T / .0133"      | 34T / .0149"          | 34T / .0149"      | 34T / .0149"          | 34T / .0149"      | 34T / .0149"                 | 34T / .0149"             |
|                        |        |                      |               | Full Faced           | 25005                 | 25006             | 25059                 | -                 | 25113                 | -                 | -                            | -                        |
|                        |        |                      | Beveled       | 25032                | 25033                 | 25086             | 25087                 | 25140             | 25141                 | -                 | -                            |                          |
| 30 (TPI)               | 0,8mm  | 90°                  | Medium        | Description          | DS-30-HS              | DS-30-C           | DDR-30-HS             | DDR-30-C          | DDL-30-HS             | DDL-30-C          | DF-30-HS                     | DF-30-C                  |
|                        |        |                      |               | Tracking Data        | 47T / .0107"          | 47T / .0107"      | 40T / .0126"          | 40T / .0126"      | 40T / .0126"          | 40T / .0126"      | 40T / .0126"                 | 40T / .0126"             |
|                        |        |                      |               | Full Faced           | 25007                 | 25008             | 25061                 | 25062             | 25115                 | 25116             | 25169                        | 25170                    |
|                        |        |                      | Beveled       | 25034                | 25035                 | 25088             | 25089                 | 25142             | 25143                 | -                 | -                            |                          |
| 35 (TPI)               | 0,7mm  | 90°                  | Medium        | Description          | DS-35-HS              | DS-35-C           | DDR-35-HS             | DDR-35-C          | DDL-35-HS             | DDL-35-C          | DF-35-HS                     | DF-35-C                  |
|                        |        |                      |               | Tracking Data        | 55T / .0092"          | 55T / .0092"      | 47T / .0107"          | 47T / .0107"      | 47T / .0107"          | 47T / .0107"      | 47T / .0107"                 | 47T / .0107"             |
|                        |        |                      |               | Full Faced           | 25009                 | 25010             | 25063                 | -                 | 25117                 | -                 | -                            | -                        |
|                        |        |                      | Beveled       | 25036                | -                     | 25090             | -                     | 25144             | -                     | -                 | -                            |                          |
| 40 (TPI)               | 0,6mm  | 90°                  | Fine          | Description          | DS-40-HS              | DS-40-C           | DDR-40-HS             | DDR-40-C          | DDL-40-HS             | DDL-40-C          | DF-40-HS                     | DF-40-C                  |
|                        |        |                      |               | Tracking Data        | 63T / .0080"          | 63T / .0080"      | 55T / .0092"          | 55T / .0092"      | 55T / .0092"          | 55T / .0092"      | 55T / .0092"                 | 55T / .0092"             |
|                        |        |                      |               | Full Faced           | -                     | -                 | 25065                 | -                 | 25119                 | -                 | -                            | 25174                    |
|                        |        |                      | Beveled       | 25038                | 25039                 | 25092             | 25093                 | 25146             | 25147                 | -                 | -                            |                          |
| 50 (TPI)               | 0,5mm  | 70°                  | Fine          | Description          | DS-50-HS              | DS-50-C           | DDR-50-HS             | DDR-50-C          | DDL-50-HS             | DDL-50-C          | DF-50-HS                     | DF-50-C                  |
|                        |        |                      |               | Tracking Data        | 79T / .0064"          | 79T / .0064"      | 68T / .0074"          | 68T / .0074"      | 68T / .0074"          | 68T / .0074"      | 68T / .0074"                 | 68T / .0074"             |
|                        |        |                      |               | Full Faced           | 25013                 | -                 | 25067                 | -                 | 25121                 | -                 | -                            | -                        |
|                        |        |                      | Beveled       | 25040                | 25041                 | 25094             | -                     | 25148             | -                     | -                 | -                            |                          |
| 80 (TPI)               | 0,3mm  | 70°                  | Fine          | Description          | DS-80-HS              | DS-80-C           | DDR-80-HS             | DDR-80-C          | DDL-80-HS             | DDL-80-C          | DF-80-HS                     | DF-80-C                  |
|                        |        |                      |               | Tracking Data        | 125T / .0040"         | 125T / .0040"     | 107T / .0047"         | 107T / .0047"     | 107T / .0047"         | 107T / .0047"     | 107T / .0047"                | 107T / .0047"            |
|                        |        |                      |               | Full Faced           | 25015                 | 25016             | 25069                 | -                 | 25123                 | -                 | -                            | -                        |
|                        |        |                      | Beveled       | -                    | 25043                 | -                 | 25097                 | -                 | 25151                 | -                 | 25205                        |                          |
| <b>Diametral Pitch</b> |        |                      |               |                      |                       |                   |                       |                   |                       |                   |                              |                          |
| 64                     | 1,2mm  | 80°                  | Medium        | Description          | DS-64-HS              | DS-64-C           | DDR-64-HS             | DDR-64-C          | DDL-64-HS             | DDL-64-C          | DF-64-HS                     | DF-64-C                  |
|                        |        |                      |               | Tracking Data        | 32T / .0156"          | 32T / .0156"      | 32T / .0156"          | 32T / .0156"      | 32T / .0156"          | 32T / .0156"      | 32T / .0156"                 | 32T / .0156"             |
|                        |        |                      |               | Full Faced           | 25017                 | -                 | -                     | -                 | -                     | -                 | -                            | -                        |
|                        |        |                      | Beveled       | -                    | -                     | 25099             | -                     | 25153             | -                     | -                 | -                            |                          |
| 96                     | 0,8mm  | 80°                  | Medium        | Description          | DS-96-HS              | DS-96-C           | DDR-96-HS             | DDR-96-C          | DDL-96-HS             | DDL-96-C          | DF-96-HS                     | DF-96-C                  |
|                        |        |                      |               | Tracking Data        | 48T / .0104"          | 48T / .0104"      | 48T / .0104"          | 48T / .0104"      | 48T / .0104"          | 48T / .0104"      | 48T / .0104"                 | 48T / .0104"             |
|                        |        |                      |               | Full Faced           | 25019                 | -                 | -                     | 25074             | -                     | 25128             | 25181                        | -                        |
|                        |        |                      | Beveled       | 25046                | -                     | -                 | 25101                 | -                 | 25155                 | -                 | -                            |                          |
| 128                    | 0,6mm  | 80°                  | Fine          | Description          | DS-128-HS             | DS-128-C          | DDR-128-HS            | DDR-128-C         | DDL-128-HS            | DDL-128-C         | DF-128-HS                    | DF-128-C                 |
|                        |        |                      |               | Tracking Data        | 64T / .0078"          | 64T / .0078"      | 64T / .0078"          | 64T / .0078"      | 64T / .0078"          | 64T / .0078"      | 64T / .0078"                 | 64T / .0078"             |
|                        |        |                      |               | Full Faced           | 25021                 | -                 | -                     | 25076             | -                     | 25130             | -                            | -                        |
|                        |        |                      | Beveled       | 25048                | -                     | -                 | -                     | -                 | -                     | -                 | -                            |                          |
| 160                    | 0,5mm  | 80°                  | Fine          | Description          | DS-160-HS             | DS-160-C          | DDR-160-HS            | DDR-160-C         | DDL-160-HS            | DDL-160-C         | DF-160-HS                    | DF-160-C                 |
|                        |        |                      |               | Tracking Data        | 80T / .0063"          | 80T / .0063"      | 80T / .0063"          | 80T / .0063"      | 80T / .0063"          | 80T / .0063"      | 80T / .0063"                 | 80T / .0063"             |
|                        |        |                      |               | Full Faced           | -                     | 25024             | -                     | 25078             | -                     | 25132             | -                            | -                        |
|                        |        |                      | Beveled       | -                    | 25051                 | -                 | -                     | -                 | -                     | -                 | -                            |                          |

## M Series

For knurl cutting, use full faced knurl wheels only.

For end-feed form knurling, use beveled knurl wheels only.

For in-feed form knurling, beveled or full faced may be used.

Knurl wheels can be reversed for right or left hand operation.

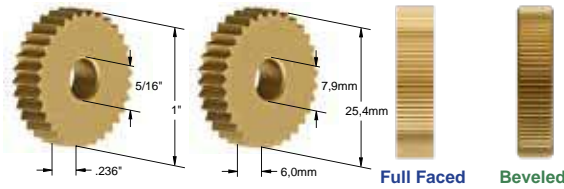

Knurl wheels are TiN coated to reduce the coefficient of friction when knurling, increasing the quality and the force of knurling as well as the life of the knurl wheels.

| Circular Knurl Pitch |                       | Included Tooth Angle  | Knurl Pattern         | M Series Knurl Wheel  | Straight              |                       | Diagonal Right        |                       | Diagonal Left         |                       | Diamond                      |                          |
|----------------------|-----------------------|-----------------------|-----------------------|-----------------------|-----------------------|-----------------------|-----------------------|-----------------------|-----------------------|-----------------------|------------------------------|--------------------------|
| Inch                 | Metric                |                       |                       |                       | High Speed TiN Coated | Cobalt TiN Coated     | High Speed TiN Coated | Cobalt TiN Coated     | High Speed TiN Coated | Cobalt TiN Coated     | Female High Speed TiN Coated | Female Cobalt TiN Coated |
| 10 (TPI)             | 2,5mm                 | 90°                   | Coarse                | Description           | MS-10-HS              | MS-10-C               | MDR-10-HS             | MDR-10-C              | MDL-10-HS             | MDL-10-C              | MF-10-HS                     | MF-10-C                  |
|                      |                       |                       |                       | Tracking Data         | 31T / .0326"          | 31T / .0326"          | 26T / .0389"          | 26T / .0389"          | 26T / .0389"          | 26T / .0389"          | 26T / .0389"                 | 26T / .0389"             |
|                      |                       |                       |                       | Full Faced            | <a href="#">25303</a> | <a href="#">25304</a> | <a href="#">25369</a> | -                     | <a href="#">25435</a> | -                     | -                            | -                        |
| Beveled              | <a href="#">25336</a> | <a href="#">25337</a> |                       | <a href="#">25402</a> | -                     | <a href="#">25468</a> | -                     | -                     | -                     |                       |                              |                          |
| 12 (TPI)             | 2,0mm                 | 90°                   |                       | Description           | MS-12-HS              | MS-12-C               | MDR-12-HS             | MDR-12-C              | MDL-12-HS             | MDL-12-C              | MF-12-HS                     | MF-12-C                  |
|                      |                       |                       |                       | Tracking Data         | 37T / .0273"          | 37T / .0273"          | 33T / .0306"          | 33T / .0306"          | 33T / .0306"          | 33T / .0306"          | 33T / .0306"                 | 33T / .0306"             |
|                      |                       |                       |                       | Full Faced            | <a href="#">25305</a> | <a href="#">25306</a> | <a href="#">25371</a> | <a href="#">25372</a> | <a href="#">25437</a> | <a href="#">25438</a> | -                            | -                        |
| Beveled              | <a href="#">25338</a> | <a href="#">25339</a> |                       | <a href="#">25404</a> | <a href="#">25405</a> | <a href="#">25470</a> | <a href="#">25471</a> | -                     | -                     |                       |                              |                          |
| 14 (TPI)             | 1,8mm                 | 90°                   |                       | Description           | MS-14-HS              | MS-14-C               | MDR-14-HS             | MDR-14-C              | MDL-14-HS             | MDL-14-C              | MF-14-HS                     | MF-14-C                  |
|                      |                       |                       |                       | Tracking Data         | 44T / .0230"          | 44T / .0230"          | 46T / .0220"          | 46T / .0220"          | 46T / .0220"          | 46T / .0220"          | 46T / .0220"                 | 46T / .0220"             |
|                      |                       |                       |                       | Full Faced            | <a href="#">25307</a> | <a href="#">25308</a> | <a href="#">25373</a> | <a href="#">25374</a> | <a href="#">25439</a> | <a href="#">25440</a> | -                            | -                        |
| Beveled              | <a href="#">25340</a> | <a href="#">25341</a> |                       | <a href="#">25406</a> | <a href="#">25407</a> | <a href="#">25472</a> | <a href="#">25473</a> | -                     | -                     |                       |                              |                          |
| 16 (TPI)             | 1,6mm                 | 90°                   | Description           | MS-16-HS              | MS-16-C               | MDR-16-HS             | MDR-16-C              | MDL-16-HS             | MDL-16-C              | MF-16-HS              | MF-16-C                      |                          |
|                      |                       |                       | Tracking Data         | 50T / .0202"          | 50T / .0202"          | 45T / .0224"          | 45T / .0224"          | 45T / .0224"          | 45T / .0224"          | 45T / .0224"          | 45T / .0224"                 |                          |
|                      |                       |                       | Full Faced            | <a href="#">25309</a> | <a href="#">25310</a> | <a href="#">25375</a> | <a href="#">25376</a> | <a href="#">25441</a> | <a href="#">25442</a> | -                     | -                            |                          |
| Beveled              | <a href="#">25342</a> | <a href="#">25343</a> | <a href="#">25408</a> | <a href="#">25409</a> | <a href="#">25474</a> | <a href="#">25475</a> | -                     | -                     |                       |                       |                              |                          |
| 20 (TPI)             | 1,2mm                 | 90°                   | Description           | MS-20-HS              | MS-20-C               | MDR-20-HS             | MDR-20-C              | MDL-20-HS             | MDL-20-C              | MF-20-HS              | MF-20-C                      |                          |
|                      |                       |                       | Tracking Data         | 61T / .0165"          | 61T / .0165"          | 54T / .0187"          | 54T / .0187"          | 54T / .0187"          | 54T / .0187"          | 54T / .0187"          | 54T / .0187"                 |                          |
|                      |                       |                       | Full Faced            | <a href="#">25311</a> | <a href="#">25312</a> | <a href="#">25377</a> | <a href="#">25378</a> | <a href="#">25443</a> | <a href="#">25444</a> | -                     | -                            |                          |
| Beveled              | -                     | <a href="#">25345</a> | <a href="#">25410</a> | <a href="#">25411</a> | <a href="#">25476</a> | <a href="#">25477</a> | -                     | <a href="#">25543</a> |                       |                       |                              |                          |
| 25 (TPI)             | 1,0mm                 | 90°                   | Description           | MS-25-HS              | MS-25-C               | MDR-25-HS             | MDR-25-C              | MDL-25-HS             | MDL-25-C              | MF-25-HS              | MF-25-C                      |                          |
|                      |                       |                       | Tracking Data         | 78T / .0129"          | 78T / .0129"          | 68T / .0148"          | 68T / .0148"          | 68T / .0148"          | 68T / .0148"          | 68T / .0148"          | 68T / .0148"                 |                          |
|                      |                       |                       | Full Faced            | <a href="#">25313</a> | <a href="#">25314</a> | <a href="#">25379</a> | <a href="#">25380</a> | <a href="#">25445</a> | <a href="#">25446</a> | -                     | -                            |                          |
| Beveled              | <a href="#">25346</a> | <a href="#">25347</a> | <a href="#">25412</a> | <a href="#">25413</a> | <a href="#">25478</a> | <a href="#">25479</a> | -                     | -                     |                       |                       |                              |                          |
| 30 (TPI)             | 0,8mm                 | 90°                   | Description           | MS-30-HS              | MS-30-C               | MDR-30-HS             | MDR-30-C              | MDL-30-HS             | MDL-30-C              | MF-30-HS              | MF-30-C                      |                          |
|                      |                       |                       | Tracking Data         | 95T / .0106"          | 95T / .0106"          | 81T / .0124"          | 81T / .0124"          | 81T / .0124"          | 81T / .0124"          | 81T / .0124"          | 81T / .0124"                 |                          |
|                      |                       |                       | Full Faced            | <a href="#">25315</a> | <a href="#">25316</a> | <a href="#">25381</a> | <a href="#">25382</a> | <a href="#">25447</a> | <a href="#">25448</a> | <a href="#">25513</a> | <a href="#">25514</a>        |                          |
| Beveled              | <a href="#">25348</a> | <a href="#">25349</a> | <a href="#">25414</a> | <a href="#">25415</a> | <a href="#">25480</a> | <a href="#">25481</a> | -                     | <a href="#">25547</a> |                       |                       |                              |                          |
| 35 (TPI)             | 0,7mm                 | 90°                   | Description           | MS-35-HS              | MS-35-C               | MDR-35-HS             | MDR-35-C              | MDL-35-HS             | MDL-35-C              | MF-35-HS              | MF-35-C                      |                          |
|                      |                       |                       | Tracking Data         | 110T / .0091"         | 110T / .0091"         | 95T / .0106"          | 95T / .0106"          | 95T / .0106"          | 95T / .0106"          | 95T / .0106"          | 95T / .0106"                 |                          |
|                      |                       |                       | Full Faced            | <a href="#">25317</a> | <a href="#">25318</a> | -                     | -                     | -                     | -                     | -                     | -                            |                          |
| Beveled              | <a href="#">25350</a> | -                     | -                     | -                     | -                     | -                     | -                     | -                     |                       |                       |                              |                          |
| 40 (TPI)             | 0,6mm                 | 90°                   | Description           | MS-40-HS              | MS-40-C               | MDR-40-HS             | MDR-40-C              | MDL-40-HS             | MDL-40-C              | MF-40-HS              | MF-40-C                      |                          |
|                      |                       |                       | Tracking Data         | 124T / .0081"         | 124T / .0081"         | 108T / .0093"         | 108T / .0093"         | 108T / .0093"         | 108T / .0093"         | 108T / .0093"         | 108T / .0093"                |                          |
|                      |                       |                       | Full Faced            | -                     | -                     | -                     | -                     | -                     | -                     | -                     | -                            |                          |
| Beveled              | -                     | -                     | -                     | -                     | -                     | -                     | -                     | -                     |                       |                       |                              |                          |
| 50 (TPI)             | 0,5mm                 | 70°                   | Description           | MS-50-HS              | MS-50-C               | MDR-50-HS             | MDR-50-C              | MDL-50-HS             | MDL-50-C              | MF-50-HS              | MF-50-C                      |                          |
|                      |                       |                       | Tracking Data         | 158T / .0063"         | 158T / .0063"         | 135T / .0074"         | 135T / .0074"         | 135T / .0074"         | 135T / .0074"         | 135T / .0074"         | 135T / .0074"                |                          |
|                      |                       |                       | Full Faced            | <a href="#">25321</a> | <a href="#">25322</a> | -                     | -                     | -                     | -                     | -                     | -                            |                          |
| Beveled              | -                     | -                     | -                     | -                     | -                     | -                     | -                     | -                     |                       |                       |                              |                          |
| Diametral Pitch      |                       |                       |                       |                       |                       |                       |                       |                       |                       |                       |                              |                          |
| 64                   | 1,2mm                 | 80°                   | Medium                | Description           | MS-64-HS              | MS-64-C               | MDR-64-HS             | MDR-64-C              | MDL-64-HS             | MDL-64-C              | MF-64-HS                     | MF-64-C                  |
|                      |                       |                       |                       | Tracking Data         | 64T / .0156"          | 64T / .0156"          | 64T / .0156"          | 64T / .0156"          | 64T / .0156"          | 64T / .0156"          | 64T / .0156"                 | 64T / .0156"             |
|                      |                       |                       |                       | Full Faced            | <a href="#">25323</a> | <a href="#">25324</a> | -                     | -                     | -                     | -                     | -                            | -                        |
| Beveled              | <a href="#">25356</a> | <a href="#">25357</a> |                       | -                     | -                     | -                     | -                     | -                     | -                     |                       |                              |                          |
| 96                   | 0,8mm                 | 80°                   |                       | Description           | MS-96-HS              | MS-96-C               | MDR-96-HS             | MDR-96-C              | MDL-96-HS             | MDL-96-C              | MF-96-HS                     | MF-96-C                  |
|                      |                       |                       |                       | Tracking Data         | 96T / .0104"          | 96T / .0104"          | 96T / .0104"          | 96T / .0104"          | 96T / .0104"          | 96T / .0104"          | 96T / .0104"                 | 96T / .0104"             |
|                      |                       |                       |                       | Full Faced            | <a href="#">25325</a> | <a href="#">25326</a> | -                     | <a href="#">25392</a> | -                     | <a href="#">25458</a> | <a href="#">25523</a>        | -                        |
| Beveled              | <a href="#">25358</a> | <a href="#">25359</a> |                       | <a href="#">25424</a> | <a href="#">25425</a> | <a href="#">25490</a> | <a href="#">25491</a> | -                     | -                     |                       |                              |                          |
| 128                  | 0,6mm                 | 80°                   |                       | Description           | MS-128-HS             | MS-128-C              | MDR-128-HS            | MDR-128-C             | MDL-128-HS            | MDL-128-C             | MF-128-HS                    | MF-128-C                 |
|                      |                       |                       |                       | Tracking Data         | 128T / .0078"         | 128T / .0078"         | 128T / .0078"         | 128T / .0078"         | 128T / .0078"         | 128T / .0078"         | 128T / .0078"                | 128T / .0078"            |
|                      |                       |                       |                       | Full Faced            | -                     | -                     | -                     | -                     | -                     | -                     | -                            | -                        |
| Beveled              | <a href="#">25360</a> | -                     |                       | -                     | -                     | -                     | -                     | -                     | -                     |                       |                              |                          |

**O Series**

For knurl cutting, use full faced knurl wheels only.  
 For end-feed form knurling, use beveled knurl wheels only.  
 For in-feed form knurling, beveled or full faced may be used.  
 Knurl wheels can be reversed for right or left hand operation.

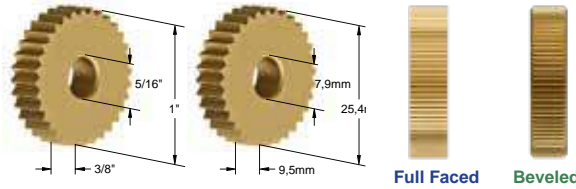

Knurl wheels are TiN coated to reduce the coefficient of friction when knurling, increasing the quality and the force of knurling as well as the life of the knurl wheels.

| Circular Knurl Pitch   |        | Included Tooth Angle | Knurl Pattern | O Series Knurl Wheel | Straight              |                   | Diagonal Right        |                   | Diagonal Left         |                   | Diamond                    |                              |
|------------------------|--------|----------------------|---------------|----------------------|-----------------------|-------------------|-----------------------|-------------------|-----------------------|-------------------|----------------------------|------------------------------|
| Inch                   | Metric |                      |               |                      | High Speed TiN Coated | Cobalt TiN Coated | High Speed TiN Coated | Cobalt TiN Coated | High Speed TiN Coated | Cobalt TiN Coated | Male High Speed TiN Coated | Female High Speed TiN Coated |
| 10 (TPI)               | 2,5mm  | 90°                  | Coarse        | Description          | OS-10-HS              | OS-10-C           | ODR-10-HS             | ODR-10-C          | ODL-10-HS             | ODL-10-C          | OM-10-HS                   | OF-10-HS                     |
|                        |        |                      |               | Tracking Data        | 31T / .0326"          | 31T / .0326"      | 26T / .0389"          | 26T / .0389"      | 26T / .0389"          | 26T / .0389"      | 26T / .0389"               | 26T / .0389"                 |
|                        |        |                      |               | Full Faced           | 25604                 | -                 | 25736                 | -                 | 25868                 | -                 | -                          | -                            |
| Beveled                | -      | -                    |               | -                    | -                     | -                 | -                     | -                 | -                     | -                 |                            |                              |
| 12 (TPI)               | 2,0mm  | 90°                  |               | Description          | OS-12-HS              | OS-12-C           | ODR-12-HS             | ODR-12-C          | ODL-12-HS             | ODL-12-C          | OM-12-HS                   | OF-12-HS                     |
|                        |        |                      |               | Tracking Data        | 37T / .0273"          | 37T / .0273"      | 33T / .0306"          | 33T / .0306"      | 33T / .0306"          | 33T / .0306"      | 33T / .0306"               | 33T / .0306"                 |
|                        |        |                      |               | Full Faced           | 25606                 | -                 | -                     | -                 | 25870                 | -                 | -                          | -                            |
| Beveled                | -      | -                    |               | 25771                | -                     | 25903             | -                     | -                 | -                     |                   |                            |                              |
| 14 (TPI)               | 1,8mm  | 90°                  |               | Description          | OS-14-HS              | OS-14-C           | ODR-14-HS             | ODR-14-C          | ODL-14-HS             | ODL-14-C          | OM-14-HS                   | OF-14-HS                     |
|                        |        |                      |               | Tracking Data        | 44T / .0230"          | 44T / .0230"      | 46T / .0220"          | 46T / .0220"      | 46T / .0220"          | 46T / .0220"      | 46T / .0220"               | 46T / .0220"                 |
|                        |        |                      |               | Full Faced           | 25608                 | 25674             | -                     | -                 | -                     | -                 | -                          | -                            |
| Beveled                | 25641  | 25707                |               | -                    | 25839                 | -                 | 25971                 | -                 | -                     |                   |                            |                              |
| 16 (TPI)               | 1,6mm  | 90°                  | Description   | OS-16-HS             | OS-16-C               | ODR-16-HS         | ODR-16-C              | ODL-16-HS         | ODL-16-C              | OM-16-HS          | OF-16-HS                   |                              |
|                        |        |                      | Tracking Data | 50T / .0202"         | 50T / .0202"          | 45T / .0224"      | 45T / .0224"          | 45T / .0224"      | 45T / .0224"          | 45T / .0224"      | 45T / .0224"               |                              |
|                        |        |                      | Full Faced    | 25610                | 25676                 | 25742             | -                     | 25874             | -                     | -                 | -                          |                              |
| Beveled                | 25643  | 25709                | -             | -                    | -                     | -                 | -                     | -                 |                       |                   |                            |                              |
| 20 (TPI)               | 1,2mm  | 90°                  | Description   | OS-20-HS             | OS-20-C               | ODR-20-HS         | ODR-20-C              | ODL-20-HS         | ODL-20-C              | OM-20-HS          | OF-20-HS                   |                              |
|                        |        |                      | Tracking Data | 61T / .0165"         | 61T / .0165"          | 54T / .0187"      | 54T / .0187"          | 54T / .0187"      | 54T / .0187"          | 54T / .0187"      | 54T / .0187"               |                              |
|                        |        |                      | Full Faced    | 25612                | 25678                 | -                 | -                     | -                 | -                     | 26008             | 26074                      |                              |
| Beveled                | 25645  | 25711                | 25777         | -                    | 25909                 | -                 | -                     | 26107             |                       |                   |                            |                              |
| 25 (TPI)               | 1,0mm  | 90°                  | Description   | OS-25-HS             | OS-25-C               | ODR-25-HS         | ODR-25-C              | ODL-25-HS         | ODL-25-C              | OM-25-HS          | OF-25-HS                   |                              |
|                        |        |                      | Tracking Data | 78T / .0129"         | 78T / .0129"          | 68T / .0148"      | 68T / .0148"          | 68T / .0148"      | 68T / .0148"          | 68T / .0148"      | 68T / .0148"               |                              |
|                        |        |                      | Full Faced    | 25614                | 25680                 | -                 | 25812                 | -                 | 25944                 | 26010             | 26076                      |                              |
| Beveled                | 25647  | 25713                | 25779         | 25845                | 25911                 | 25977             | 26043                 | 26109             |                       |                   |                            |                              |
| 30 (TPI)               | 0,8mm  | 90°                  | Description   | OS-30-HS             | OS-30-C               | ODR-30-HS         | ODR-30-C              | ODL-30-HS         | ODL-30-C              | OM-30-HS          | OF-30-HS                   |                              |
|                        |        |                      | Tracking Data | 95T / .0106"         | 95T / .0106"          | 81T / .0124"      | 81T / .0124"          | 81T / .0124"      | 81T / .0124"          | 81T / .0124"      | 81T / .0124"               |                              |
|                        |        |                      | Full Faced    | 25616                | 25682                 | -                 | -                     | -                 | -                     | 26012             | 26078                      |                              |
| Beveled                | 25649  | -                    | -             | -                    | -                     | -                 | -                     | 26111             |                       |                   |                            |                              |
| 35 (TPI)               | 0,7mm  | 90°                  | Description   | OS-35-HS             | OS-35-C               | ODR-35-HS         | ODR-35-C              | ODL-35-HS         | ODL-35-C              | OM-35-HS          | OF-35-HS                   |                              |
|                        |        |                      | Tracking Data | 110T / .0091"        | 110T / .0091"         | 95T / .0106"      | 95T / .0106"          | 95T / .0106"      | 95T / .0106"          | 95T / .0106"      | 95T / .0106"               |                              |
|                        |        |                      | Full Faced    | 25618                | 25684                 | -                 | -                     | -                 | -                     | -                 | -                          |                              |
| Beveled                | -      | -                    | -             | -                    | -                     | -                 | -                     | -                 |                       |                   |                            |                              |
| 40 (TPI)               | 0,6mm  | 90°                  | Description   | OS-40-HS             | OS-40-C               | ODR-40-HS         | ODR-40-C              | ODL-40-HS         | ODL-40-C              | OM-40-HS          | OF-40-HS                   |                              |
|                        |        |                      | Tracking Data | 124T / .0081"        | 124T / .0081"         | 108T / .0093"     | 108T / .0093"         | 108T / .0093"     | 108T / .0093"         | 108T / .0093"     | 108T / .0093"              |                              |
|                        |        |                      | Full Faced    | -                    | -                     | -                 | -                     | -                 | -                     | -                 | -                          |                              |
| Beveled                | -      | -                    | -             | -                    | -                     | -                 | -                     | -                 |                       |                   |                            |                              |
| 50 (TPI)               | 0,5mm  | 70°                  | Description   | OS-50-HS             | OS-50-C               | ODR-50-HS         | ODR-50-C              | ODL-50-HS         | ODL-50-C              | OM-50-HS          | OF-50-HS                   |                              |
|                        |        |                      | Tracking Data | 158T / .0063"        | 158T / .0063"         | 135T / .0074"     | 135T / .0074"         | 135T / .0074"     | 135T / .0074"         | 135T / .0074"     | 135T / .0074"              |                              |
|                        |        |                      | Full Faced    | -                    | -                     | -                 | -                     | -                 | -                     | -                 | -                          |                              |
| Beveled                | -      | -                    | -             | -                    | -                     | -                 | -                     | -                 |                       |                   |                            |                              |
| <b>Diametral Pitch</b> |        |                      |               |                      |                       |                   |                       |                   |                       |                   |                            |                              |
| 64                     | 1,2mm  | 80°                  | Medium        | Description          | OS-64-HS              | OS-64-C           | ODR-64-HS             | ODR-64-C          | ODL-64-HS             | ODL-64-C          | OM-64-HS                   | OF-64-HS                     |
|                        |        |                      |               | Tracking Data        | 64T / .0156"          | 64T / .0156"      | 64T / .0156"          | 64T / .0156"      | 64T / .0156"          | 64T / .0156"      | 64T / .0156"               | 64T / .0156"                 |
|                        |        |                      |               | Full Faced           | 25624                 | -                 | -                     | -                 | -                     | -                 | -                          | -                            |
| Beveled                | 25657  | -                    |               | -                    | -                     | -                 | -                     | -                 | -                     |                   |                            |                              |
| 96                     | 0,8mm  | 80°                  |               | Description          | OS-96-HS              | OS-96-C           | ODR-96-HS             | ODR-96-C          | ODL-96-HS             | ODL-96-C          | OM-96-HS                   | OF-96-HS                     |
|                        |        |                      |               | Tracking Data        | 96T / .0104"          | 96T / .0104"      | 96T / .0104"          | 96T / .0104"      | 96T / .0104"          | 96T / .0104"      | 96T / .0104"               | 96T / .0104"                 |
|                        |        |                      |               | Full Faced           | 25626                 | -                 | -                     | -                 | -                     | -                 | -                          | -                            |
| Beveled                | 25659  | -                    |               | -                    | -                     | -                 | -                     | -                 | -                     |                   |                            |                              |
| 128                    | 0,6mm  | 80°                  |               | Description          | OS-128-HS             | OS-128-C          | ODR-128-HS            | ODR-128-C         | ODL-128-HS            | ODL-128-C         | OM-128-HS                  | OF-128-HS                    |
|                        |        |                      |               | Tracking Data        | 128T / .0078"         | 128T / .0078"     | 128T / .0078"         | 128T / .0078"     | 128T / .0078"         | 128T / .0078"     | 128T / .0078"              | 128T / .0078"                |
|                        |        |                      |               | Full Faced           | -                     | 25694             | -                     | -                 | -                     | -                 | -                          | -                            |
| Beveled                | -      | -                    |               | -                    | -                     | -                 | -                     | -                 | -                     |                   |                            |                              |

## P Series

For knurl cutting, use full faced knurl wheels only.

For end-feed form knurling, use beveled knurl wheels only.

For in-feed form knurling, beveled or full faced may be used.

Knurl wheels can be reversed for right or left hand operation.

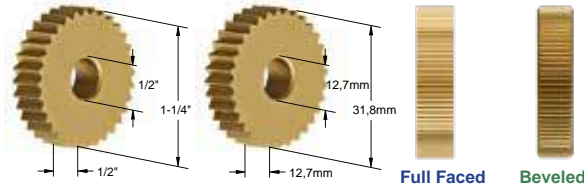

Knurl wheels are TiN coated to reduce the coefficient of friction when knurling, increasing the quality and the force of knurling as well as the life of the knurl wheels.

| Circular Knurl Pitch |        | Included Tooth Angle | Knurl Pattern | P Series Knurl Wheel | Straight              |                   | Diagonal Right        |                   | Diagonal Left         |                   | Diamond                    |                              |
|----------------------|--------|----------------------|---------------|----------------------|-----------------------|-------------------|-----------------------|-------------------|-----------------------|-------------------|----------------------------|------------------------------|
| Inch                 | Metric |                      |               |                      | High Speed TiN Coated | Cobalt TiN Coated | High Speed TiN Coated | Cobalt TiN Coated | High Speed TiN Coated | Cobalt TiN Coated | Male High Speed TiN Coated | Female High Speed TiN Coated |
| 10 (TPI)             | 2,5mm  | 90°                  | Coarse        | Description          | PS-10-HS              | PS-10-C           | PDR-10-HS             | PDR-10-C          | PDL-10-HS             | PDL-10-C          | PM-10-HS                   | PF-10-HS                     |
|                      |        |                      |               | Tracking Data        | 39T / .0323"          | 39T / .0323"      | 34T / .0371"          | 34T / .0371"      | 34T / .0371"          | 34T / .0371"      | 34T / .0371"               | 34T / .0371"                 |
|                      |        |                      |               | Full Faced           | -                     | -                 | -                     | -                 | -                     | -                 | -                          | -                            |
|                      |        |                      |               | Beveled              | 26215                 | -                 | -                     | -                 | -                     | -                 | -                          | -                            |
| 12 (TPI)             | 2,0mm  | 90°                  | Coarse        | Description          | PS-12-HS              | PS-12-C           | PDR-12-HS             | PDR-12-C          | PDL-12-HS             | PDL-12-C          | PM-12-HS                   | PF-12-HS                     |
|                      |        |                      |               | Tracking Data        | 47T / .0268"          | 47T / .0268"      | 41T / .0307"          | 41T / .0307"      | 41T / .0307"          | 41T / .0307"      | 41T / .0307"               | 41T / .0307"                 |
|                      |        |                      |               | Full Faced           | -                     | -                 | 26268                 | -                 | 26336                 | -                 | 26404                      | -                            |
|                      |        |                      |               | Beveled              | 26217                 | -                 | 26285                 | -                 | 26353                 | -                 | -                          | -                            |
| 14 (TPI)             | 1,8mm  | 90°                  | Coarse        | Description          | PS-14-HS              | PS-14-C           | PDR-14-HS             | PDR-14-C          | PDL-14-HS             | PDL-14-C          | PM-14-HS                   | PF-14-HS                     |
|                      |        |                      |               | Tracking Data        | 55T / .0229"          | 55T / .0229"      | 55T / .0229"          | 55T / .0229"      | 55T / .0229"          | 55T / .0229"      | 55T / .0229"               | 55T / .0229"                 |
|                      |        |                      |               | Full Faced           | 26202                 | -                 | -                     | -                 | -                     | -                 | -                          | -                            |
|                      |        |                      |               | Beveled              | -                     | -                 | -                     | -                 | -                     | -                 | -                          | -                            |
| 16 (TPI)             | 1,6mm  | 90°                  | Coarse        | Description          | PS-16-HS              | PS-16-C           | PDR-16-HS             | PDR-16-C          | PDL-16-HS             | PDL-16-C          | PM-16-HS                   | PF-16-HS                     |
|                      |        |                      |               | Tracking Data        | 63T / .0200"          | 63T / .0200"      | 53T / .0238"          | 53T / .0238"      | 53T / .0238"          | 53T / .0238"      | 53T / .0238"               | 53T / .0238"                 |
|                      |        |                      |               | Full Faced           | -                     | 26238             | -                     | -                 | -                     | 26408             | 26442                      | -                            |
|                      |        |                      |               | Beveled              | -                     | -                 | -                     | 26323             | -                     | 26391             | -                          | 26459                        |
| 20 (TPI)             | 1,2mm  | 90°                  | Medium        | Description          | PS-20-HS              | PS-20-C           | PDR-20-HS             | PDR-20-C          | PDL-20-HS             | PDL-20-C          | PM-20-HS                   | PF-20-HS                     |
|                      |        |                      |               | Tracking Data        | 79T / .0159"          | 79T / .0159"      | 68T / .0185"          | 68T / .0185"      | 68T / .0185"          | 68T / .0185"      | 68T / .0185"               | 68T / .0185"                 |
|                      |        |                      |               | Full Faced           | -                     | 26240             | 26274                 | -                 | 26342                 | -                 | 26410                      | -                            |
|                      |        |                      |               | Beveled              | -                     | 26257             | -                     | -                 | -                     | 26427             | -                          |                              |
| 25 (TPI)             | 1,0mm  | 90°                  | Medium        | Description          | PS-25-HS              | PS-25-C           | PDR-25-HS             | PDR-25-C          | PDL-25-HS             | PDL-25-C          | PM-25-HS                   | PF-25-HS                     |
|                      |        |                      |               | Tracking Data        | 97T / .0130"          | 97T / .0130"      | 85T / .0148"          | 85T / .0148"      | 85T / .0148"          | 85T / .0148"      | 85T / .0148"               | 85T / .0148"                 |
|                      |        |                      |               | Full Faced           | -                     | 26242             | -                     | -                 | -                     | -                 | 26446                      | -                            |
|                      |        |                      |               | Beveled              | 26225                 | 26259             | 26293                 | -                 | 26361                 | -                 | 26429                      | -                            |
| 30 (TPI)             | 0,8mm  | 90°                  | Medium        | Description          | PS-30-HS              | PS-30-C           | PDR-30-HS             | PDR-30-C          | PDL-30-HS             | PDL-30-C          | PM-30-HS                   | PF-30-HS                     |
|                      |        |                      |               | Tracking Data        | 117T / .0107"         | 117T / .0107"     | 103T / .0122"         | 103T / .0122"     | 103T / .0122"         | 103T / .0122"     | 103T / .0122"              | 103T / .0122"                |
|                      |        |                      |               | Full Faced           | -                     | -                 | 26278                 | -                 | 26346                 | -                 | -                          | -                            |
|                      |        |                      |               | Beveled              | -                     | 26261             | -                     | -                 | -                     | -                 | -                          | -                            |
| Diametral Pitch      |        |                      |               |                      |                       |                   |                       |                   |                       |                   |                            |                              |
| 64                   | 1,2mm  | 80°                  | Medium        | Description          | PS-64-HS              | PS-64-C           | PDR-64-HS             | PDR-64-C          | PDL-64-HS             | PDL-64-C          | PM-64-HS                   | PF-64-HS                     |
|                      |        |                      |               | Tracking Data        | 81T / .0156"          | 81T / .0156"      | 81T / .0156"          | 81T / .0156"      | 81T / .0156"          | 81T / .0156"      | 81T / .0156"               | 81T / .0156"                 |
|                      |        |                      |               | Full Faced           | -                     | -                 | -                     | -                 | -                     | -                 | -                          | -                            |
| 96                   | 0,8mm  | 80°                  | Medium        | Description          | PS-96-HS              | PS-96-C           | PDR-96-HS             | PDR-96-C          | PDL-96-HS             | PDL-96-C          | PM-96-HS                   | PF-96-HS                     |
|                      |        |                      |               | Tracking Data        | 121T / .0104"         | 121T / .0104"     | 121T / .0104"         | 121T / .0104"     | 121T / .0104"         | 121T / .0104"     | 121T / .0104"              | 121T / .0104"                |
|                      |        |                      |               | Full Faced           | -                     | 26248             | 26282                 | -                 | 26350                 | -                 | -                          | -                            |
|                      |        |                      |               | Beveled              | -                     | 26265             | -                     | -                 | -                     | -                 | -                          |                              |

**R Series**

For knurl cutting, use full faced knurl wheels only.  
 For end-feed form knurling, use beveled knurl wheels only.  
 For in-feed form knurling, beveled or full faced may be used.  
 Knurl wheels can be reversed for right or left hand operation.

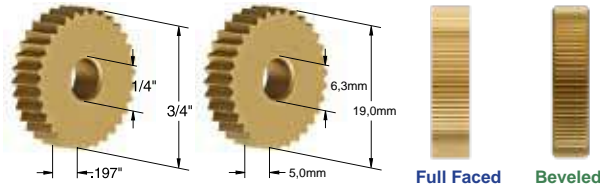

Knurl wheels are TiN coated to reduce the coefficient of friction when knurling, increasing the quality and the force of knurling as well as the life of the knurl wheels.

| Circular Knurl Pitch |        | Included Tooth Angle | Knurl Pattern | R Series Knurl Wheel | Straight              |                   | Diagonal Right        |                   | Diagonal Left         |                   | Diamond                      |                          |
|----------------------|--------|----------------------|---------------|----------------------|-----------------------|-------------------|-----------------------|-------------------|-----------------------|-------------------|------------------------------|--------------------------|
| Inch                 | Metric |                      |               |                      | High Speed TiN Coated | Cobalt TiN Coated | High Speed TiN Coated | Cobalt TiN Coated | High Speed TiN Coated | Cobalt TiN Coated | Female High Speed TiN Coated | Female Cobalt TiN Coated |
| 10 (TPI)             | 2,5mm  | 90°                  | Coarse        | Description          | RS-10-HS              | RS-10-C           | RDR-10-HS             | RDR-10-C          | RDL-10-HS             | RDL-10-C          | RF-10-HS                     | RF-10-C                  |
|                      |        |                      |               | Tracking Data        | 23T / .0330"          | 23T / .0330"      | 20T / .0380"          | 20T / .0380"      | 20T / .0380"          | 20T / .0380"      | 20T / .0380"                 | 20T / .0380"             |
|                      |        |                      |               | Full Faced           | 26501                 | 26502             | 26563                 | 26564             | 26625                 | 26626             | -                            | -                        |
| Beveled              | 26532  | -                    |               | -                    | -                     | -                 | -                     | -                 | -                     | -                 |                              |                          |
| 12 (TPI)             | 2,0mm  | 90°                  |               | Description          | RS-12-HS              | RS-12-C           | RDR-12-HS             | RDR-12-C          | RDL-12-HS             | RDL-12-C          | RF-12-HS                     | RF-12-C                  |
|                      |        |                      |               | Tracking Data        | 28T / .0271"          | 28T / .0271"      | 25T / .0304"          | 25T / .0304"      | 25T / .0304"          | 25T / .0304"      | 25T / .0304"                 | 25T / .0304"             |
|                      |        |                      |               | Full Faced           | 26503                 | 26504             | -                     | 26566             | -                     | 26628             | -                            | -                        |
| Beveled              | -      | 26535                |               | -                    | -                     | -                 | -                     | -                 | -                     | -                 |                              |                          |
| 14 (TPI)             | 1,8mm  | 90°                  |               | Description          | RS-14-HS              | RS-14-C           | RDR-14-HS             | RDR-14-C          | RDL-14-HS             | RDL-14-C          | RF-14-HS                     | RF-14-C                  |
|                      |        |                      |               | Tracking Data        | 34T / .0224"          | 34T / .0224"      | 34T / .0224"          | 34T / .0224"      | 34T / .0224"          | 34T / .0224"      | 34T / .0224"                 | 34T / .0224"             |
|                      |        |                      |               | Full Faced           | 26505                 | 26506             | 26567                 | 26568             | 26629                 | 26630             | -                            | -                        |
| Beveled              | 26536  | 26537                |               | -                    | -                     | -                 | -                     | -                 | -                     | -                 |                              |                          |
| 16 (TPI)             | 1,6mm  | 90°                  | Description   | RS-16-HS             | RS-16-C               | RDR-16-HS         | RDR-16-C              | RDL-16-HS         | RDL-16-C              | RF-16-HS          | RF-16-C                      |                          |
|                      |        |                      | Tracking Data | 38T / .0200"         | 38T / .0200"          | 33T / .0230"      | 33T / .0230"          | 33T / .0230"      | 33T / .0230"          | 33T / .0230"      | 33T / .0230"                 |                          |
|                      |        |                      | Full Faced    | 26507                | 26508                 | 26569             | -                     | 26631             | -                     | -                 | -                            |                          |
| Beveled              | 26538  | 26539                | -             | -                    | -                     | -                 | -                     | -                 | -                     |                   |                              |                          |
| 20 (TPI)             | 1,2mm  | 90°                  | Description   | RS-20-HS             | RS-20-C               | RDR-20-HS         | RDR-20-C              | RDL-20-HS         | RDL-20-C              | RF-20-HS          | RF-20-C                      |                          |
|                      |        |                      | Tracking Data | 47T / .0161"         | 47T / .0161"          | 41T / .0185"      | 41T / .0185"          | 41T / .0185"      | 41T / .0185"          | 41T / .0185"      | 41T / .0185"                 |                          |
|                      |        |                      | Full Faced    | 26509                | 26510                 | 26571             | 26572                 | 26633             | 26634                 | -                 | -                            |                          |
| Beveled              | 26540  | 26541                | -             | 26603                | -                     | 26665             | -                     | -                 | -                     |                   |                              |                          |
| 25 (TPI)             | 1,0mm  | 90°                  | Description   | RS-25-HS             | RS-25-C               | RDR-25-HS         | RDR-25-C              | RDL-25-HS         | RDL-25-C              | RF-25-HS          | RF-25-C                      |                          |
|                      |        |                      | Tracking Data | 59T / .0128"         | 59T / .0128"          | 51T / .0148"      | 51T / .0148"          | 51T / .0148"      | 51T / .0148"          | 51T / .0148"      | 51T / .0148"                 |                          |
|                      |        |                      | Full Faced    | 26511                | 26512                 | 26573             | 26574                 | 26635             | 26636                 | 26697             | -                            |                          |
| Beveled              | 26542  | 26543                | 26604         | -                    | 26666                 | -                 | -                     | -                 | -                     |                   |                              |                          |
| 30 (TPI)             | 0,8mm  | 90°                  | Description   | RS-30-HS             | RS-30-C               | RDR-30-HS         | RDR-30-C              | RDL-30-HS         | RDL-30-C              | RF-30-HS          | RF-30-C                      |                          |
|                      |        |                      | Tracking Data | 71T / .0106"         | 71T / .0106"          | 61T / .0124"      | 61T / .0124"          | 61T / .0124"      | 61T / .0124"          | 61T / .0124"      | 61T / .0124"                 |                          |
|                      |        |                      | Full Faced    | 26513                | 26514                 | 26575             | 26576                 | 26637             | 26638                 | -                 | -                            |                          |
| Beveled              | 26544  | 26545                | 26606         | 26607                | 26668                 | 26669             | -                     | 26731             |                       |                   |                              |                          |
| 35 (TPI)             | 0,7mm  | 90°                  | Description   | RS-35-HS             | RS-35-C               | RDR-35-HS         | RDR-35-C              | RDL-35-HS         | RDL-35-C              | RF-35-HS          | RF-35-C                      |                          |
|                      |        |                      | Tracking Data | 82T / .0092"         | 82T / .0092"          | 71T / .0106"      | 71T / .0106"          | 71T / .0106"      | 71T / .0106"          | 71T / .0106"      | 71T / .0106"                 |                          |
|                      |        |                      | Full Faced    | 26515                | 26516                 | -                 | -                     | -                 | -                     | -                 | -                            |                          |
| Beveled              | -      | 26547                | 26608         | -                    | 26670                 | -                 | -                     | -                 | -                     |                   |                              |                          |
| 40 (TPI)             | 0,6mm  | 90°                  | Description   | RS-40-HS             | RS-40-C               | RDR-40-HS         | RDR-40-C              | RDL-40-HS         | RDL-40-C              | RF-40-HS          | RF-40-C                      |                          |
|                      |        |                      | Tracking Data | 94T / .0080"         | 94T / .0080"          | 81T / .0093"      | 81T / .0093"          | 81T / .0093"      | 81T / .0093"          | 81T / .0093"      | 81T / .0093"                 |                          |
|                      |        |                      | Full Faced    | 26517                | 26518                 | 26579             | 26580                 | 26641             | 26642                 | -                 | -                            |                          |
| Beveled              | 26548  | -                    | -             | 26611                | -                     | -                 | -                     | -                 | -                     |                   |                              |                          |
| 50 (TPI)             | 0,5mm  | 70°                  | Description   | RS-50-HS             | RS-50-C               | RDR-50-HS         | RDR-50-C              | RDL-50-HS         | RDL-50-C              | RF-50-HS          | RF-50-C                      |                          |
|                      |        |                      | Tracking Data | 117T / .0064"        | 117T / .0064"         | 102T / .0074"     | 102T / .0074"         | 102T / .0074"     | 102T / .0074"         | 102T / .0074"     | 102T / .0074"                |                          |
|                      |        |                      | Full Faced    | 26519                | 26520                 | -                 | 26582                 | -                 | 26644                 | -                 | 26706                        |                          |
| Beveled              | -      | -                    | 26612         | -                    | 26674                 | -                 | -                     | -                 | -                     |                   |                              |                          |
| Diametral Pitch      |        |                      |               |                      |                       |                   |                       |                   |                       |                   |                              |                          |
| 64                   | 1,2mm  | 80°                  | Medium        | Description          | RS-64-HS              | RS-64-C           | RDR-64-HS             | RDR-64-C          | RDL-64-HS             | RDL-64-C          | RF-64-HS                     | RF-64-C                  |
|                      |        |                      |               | Tracking Data        | 48T / .0156"          | 48T / .0156"      | 48T / .0156"          | 48T / .0156"      | 48T / .0156"          | 48T / .0156"      | 48T / .0156"                 | 48T / .0156"             |
|                      |        |                      |               | Full Faced           | 26521                 | -                 | 26583                 | -                 | 26645                 | -                 | -                            | -                        |
| Beveled              | -      | -                    |               | -                    | -                     | -                 | -                     | -                 | -                     | -                 |                              |                          |
| 96                   | 0,8mm  | 80°                  |               | Description          | RS-96-HS              | RS-96-C           | RDR-96-HS             | RDR-96-C          | RDL-96-HS             | RDL-96-C          | RF-96-HS                     | RF-96-C                  |
|                      |        |                      |               | Tracking Data        | 72T / .0104"          | 72T / .0104"      | 72T / .0104"          | 72T / .0104"      | 72T / .0104"          | 72T / .0104"      | 72T / .0104"                 | 72T / .0104"             |
|                      |        |                      |               | Full Faced           | 26523                 | 26524             | -                     | 26586             | -                     | 26648             | -                            | -                        |
| Beveled              | 26554  | 26555                |               | -                    | 26617                 | -                 | 26679                 | -                 | -                     | -                 |                              |                          |
| 128                  | 0,6mm  | 80°                  |               | Description          | RS-128-HS             | RS-128-C          | RDR-128-HS            | RDR-128-C         | RDL-128-HS            | RDL-128-C         | RF-128-HS                    | RF-128-C                 |
|                      |        |                      |               | Tracking Data        | 96T / .0078"          | 96T / .0078"      | 96T / .0078"          | 96T / .0078"      | 96T / .0078"          | 96T / .0078"      | 96T / .0078"                 | 96T / .0078"             |
|                      |        |                      |               | Full Faced           | -                     | 26526             | -                     | 26588             | -                     | 26650             | -                            | -                        |
| Beveled              | -      | -                    |               | -                    | -                     | -                 | -                     | -                 | -                     | -                 |                              |                          |
| 160                  | 0,5mm  | 80°                  | Description   | RS-160-HS            | RS-160-C              | RDR-160-HS        | RDR-160-C             | RDL-160-HS        | RDL-160-C             | RF-160-HS         | RF-160-C                     |                          |
|                      |        |                      | Tracking Data | 120T / .0063"        | 120T / .0063"         | 120T / .0063"     | 120T / .0063"         | 120T / .0063"     | 120T / .0063"         | 120T / .0063"     | 120T / .0063"                |                          |
|                      |        |                      | Full Faced    | -                    | -                     | -                 | -                     | -                 | -                     | -                 | -                            |                          |
| Beveled              | -      | -                    | -             | -                    | -                     | -                 | -                     | -                 | -                     |                   |                              |                          |

## S Series

For knurl cutting, use full faced knurl wheels only.

For end-feed form knurling, use beveled knurl wheels only.

For in-feed form knurling, beveled or full faced may be used.

Knurl wheels can be reversed for right or left hand operation.

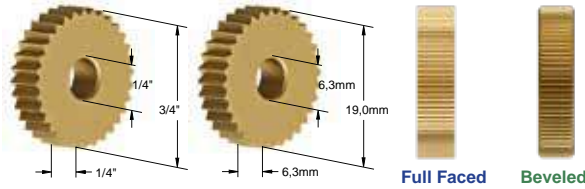

Knurl wheels are TiN coated to reduce the coefficient of friction when knurling, increasing the quality and the force of knurling as well as the life of the knurl wheels.

| Circular Knurl Pitch |        | Included Tooth Angle | Knurl Pattern | S Series Knurl Wheel | Straight              |                   | Diagonal Right        |                   | Diagonal Left         |                   | Diamond                    |                              |
|----------------------|--------|----------------------|---------------|----------------------|-----------------------|-------------------|-----------------------|-------------------|-----------------------|-------------------|----------------------------|------------------------------|
| Inch                 | Metric |                      |               |                      | High Speed TiN Coated | Cobalt TiN Coated | High Speed TiN Coated | Cobalt TiN Coated | High Speed TiN Coated | Cobalt TiN Coated | Male High Speed TiN Coated | Female High Speed TiN Coated |
| 10 (TPI)             | 2,5mm  | 90°                  | Coarse        | Description          | SS-10-HS              | SS-10-C           | SDR-10-HS             | SDR-10-C          | SDL-10-HS             | SDL-10-C          | SM-10-HS                   | SF-10-HS                     |
|                      |        |                      |               | Tracking Data        | 23T / .0330"          | 23T / .0330"      | 20T / .0380"          | 20T / .0380"      | 20T / .0380"          | 20T / .0380"      | 20T / .0380"               | 20T / .0380"                 |
| Full Faced           | -      | 26862                |               | 26924                | -                     | 27048             | -                     | -                 |                       |                   |                            |                              |
| Beveled              | -      | -                    |               | -                    | -                     | -                 | -                     | -                 |                       |                   |                            |                              |
| 12 (TPI)             | 2,0mm  | 90°                  |               | Description          | SS-12-HS              | SS-12-C           | SDR-12-HS             | SDR-12-C          | SDL-12-HS             | SDL-12-C          | SM-12-HS                   | SF-12-HS                     |
|                      |        |                      |               | Tracking Data        | 28T / .0271"          | 28T / .0271"      | 25T / .0304"          | 25T / .0304"      | 25T / .0304"          | 25T / .0304"      | 25T / .0304"               | 25T / .0304"                 |
| Full Faced           | 26804  | 26864                |               | 26926                | -                     | 27050             | -                     | -                 |                       |                   |                            |                              |
| Beveled              | -      | 26895                |               | -                    | -                     | -                 | -                     | -                 |                       |                   |                            |                              |
| 14 (TPI)             | 1,8mm  | 90°                  |               | Description          | SS-14-HS              | SS-14-C           | SDR-14-HS             | SDR-14-C          | SDL-14-HS             | SDL-14-C          | SM-14-HS                   | SF-14-HS                     |
|                      |        |                      |               | Tracking Data        | 34T / .0224"          | 34T / .0224"      | 34T / .0224"          | 34T / .0224"      | 34T / .0224"          | 34T / .0224"      | 34T / .0224"               | 34T / .0224"                 |
| Full Faced           | 26806  | -                    | -             | -                    | -                     | -                 | -                     |                   |                       |                   |                            |                              |
| Beveled              | -      | -                    | 26959         | -                    | 27083                 | -                 | -                     |                   |                       |                   |                            |                              |
| 16 (TPI)             | 1,6mm  | 90°                  | Description   | SS-16-HS             | SS-16-C               | SDR-16-HS         | SDR-16-C              | SDL-16-HS         | SDL-16-C              | SM-16-HS          | SF-16-HS                   |                              |
|                      |        |                      | Tracking Data | 38T / .0200"         | 38T / .0200"          | 33T / .0230"      | 33T / .0230"          | 33T / .0230"      | 33T / .0230"          | 33T / .0230"      | 33T / .0230"               |                              |
| Full Faced           | 26808  | 26868                | -             | -                    | -                     | -                 | 27178                 |                   |                       |                   |                            |                              |
| Beveled              | -      | -                    | -             | -                    | -                     | -                 | -                     |                   |                       |                   |                            |                              |
| 20 (TPI)             | 1,2mm  | 90°                  | Description   | SS-20-HS             | SS-20-C               | SDR-20-HS         | SDR-20-C              | SDL-20-HS         | SDL-20-C              | SM-20-HS          | SF-20-HS                   |                              |
|                      |        |                      | Tracking Data | 47T / .0161"         | 47T / .0161"          | 41T / .0185"      | 41T / .0185"          | 41T / .0185"      | 41T / .0185"          | 41T / .0185"      | 41T / .0185"               |                              |
| Full Faced           | 26810  | 26870                | -             | 26994                | -                     | 27118             | -                     |                   |                       |                   |                            |                              |
| Beveled              | 26841  | -                    | -             | -                    | -                     | -                 | -                     |                   |                       |                   |                            |                              |
| 25 (TPI)             | 1,0mm  | 90°                  | Description   | SS-25-HS             | SS-25-C               | SDR-25-HS         | SDR-25-C              | SDL-25-HS         | SDL-25-C              | SM-25-HS          | SF-25-HS                   |                              |
|                      |        |                      | Tracking Data | 59T / .0128"         | 59T / .0128"          | 51T / .0148"      | 51T / .0148"          | 51T / .0148"      | 51T / .0148"          | 51T / .0148"      | 51T / .0148"               |                              |
| Full Faced           | 26812  | 26872                | 26934         | -                    | 27058                 | -                 | 27182                 |                   |                       |                   |                            |                              |
| Beveled              | 26843  | 26903                | 26965         | -                    | 27089                 | -                 | -                     |                   |                       |                   |                            |                              |
| 30 (TPI)             | 0,8mm  | 90°                  | Description   | SS-30-HS             | SS-30-C               | SDR-30-HS         | SDR-30-C              | SDL-30-HS         | SDL-30-C              | SM-30-HS          | SF-30-HS                   |                              |
|                      |        |                      | Tracking Data | 71T / .0106"         | 71T / .0106"          | 61T / .0124"      | 61T / .0124"          | 61T / .0124"      | 61T / .0124"          | 61T / .0124"      | 61T / .0124"               |                              |
| Full Faced           | 26814  | 26874                | 26936         | 26998                | 27060                 | -                 | -                     |                   |                       |                   |                            |                              |
| Beveled              | 26845  | 26905                | 26967         | -                    | -                     | -                 | -                     |                   |                       |                   |                            |                              |
| 35 (TPI)             | 0,7mm  | 90°                  | Description   | SS-35-HS             | SS-35-C               | SDR-35-HS         | SDR-35-C              | SDL-35-HS         | SDL-35-C              | SM-35-HS          | SF-35-HS                   |                              |
|                      |        |                      | Tracking Data | 82T / .0092"         | 82T / .0092"          | 71T / .0106"      | 71T / .0106"          | 71T / .0106"      | 71T / .0106"          | 71T / .0106"      | 71T / .0106"               |                              |
| Full Faced           | 26816  | -                    | -             | 27000                | -                     | 27124             | -                     |                   |                       |                   |                            |                              |
| Beveled              | -      | -                    | -             | -                    | -                     | -                 | -                     |                   |                       |                   |                            |                              |
| 40 (TPI)             | 0,6mm  | 90°                  | Description   | SS-40-HS             | SS-40-C               | SDR-40-HS         | SDR-40-C              | SDL-40-HS         | SDL-40-C              | SM-40-HS          | SF-40-HS                   |                              |
|                      |        |                      | Tracking Data | 94T / .0080"         | 94T / .0080"          | 81T / .0093"      | 81T / .0093"          | 81T / .0093"      | 81T / .0093"          | 81T / .0093"      | 81T / .0093"               |                              |
| Full Faced           | 26818  | -                    | -             | -                    | -                     | -                 | 27250                 |                   |                       |                   |                            |                              |
| Beveled              | -      | -                    | 27033         | -                    | 27157                 | -                 | -                     |                   |                       |                   |                            |                              |
| 50 (TPI)             | 0,5mm  | 70°                  | Description   | SS-50-HS             | SS-50-C               | SDR-50-HS         | SDR-50-C              | SDL-50-HS         | SDL-50-C              | SM-50-HS          | SF-50-HS                   |                              |
|                      |        |                      | Tracking Data | 117T / .0064"        | 117T / .0064"         | 102T / .0074"     | 102T / .0074"         | 102T / .0074"     | 102T / .0074"         | 102T / .0074"     | 102T / .0074"              |                              |
| Full Faced           | -      | -                    | 26942         | 27004                | 27066                 | 27128             | -                     | 27252             |                       |                   |                            |                              |
| Beveled              | -      | -                    | -             | -                    | -                     | -                 | -                     |                   |                       |                   |                            |                              |
| Diametral Pitch      |        |                      |               |                      |                       |                   |                       |                   |                       |                   |                            |                              |
| 64                   | 1,2mm  | 80°                  | Medium        | Description          | SS-64-HS              | SS-64-C           | SDR-64-HS             | SDR-64-C          | SDL-64-HS             | SDL-64-C          | SM-64-HS                   | SF-64-HS                     |
|                      |        |                      |               | Tracking Data        | 48T / .0156"          | 48T / .0156"      | 48T / .0156"          | 48T / .0156"      | 48T / .0156"          | 48T / .0156"      | 48T / .0156"               | 48T / .0156"                 |
| Full Faced           | 26822  | 26882                |               | -                    | -                     | 27130             | -                     | -                 |                       |                   |                            |                              |
| Beveled              | -      | -                    |               | 26975                | -                     | 27099             | -                     | -                 |                       |                   |                            |                              |
| 96                   | 0,8mm  | 80°                  |               | Description          | SS-96-HS              | SS-96-C           | SDR-96-HS             | SDR-96-C          | SDL-96-HS             | SDL-96-C          | SM-96-HS                   | SF-96-HS                     |
|                      |        |                      |               | Tracking Data        | 72T / .0104"          | 72T / .0104"      | 72T / .0104"          | 72T / .0104"      | 72T / .0104"          | 72T / .0104"      | 72T / .0104"               | 72T / .0104"                 |
| Full Faced           | 26824  | 26884                |               | -                    | -                     | -                 | -                     | -                 |                       |                   |                            |                              |
| Beveled              | -      | -                    |               | -                    | -                     | -                 | -                     | -                 |                       |                   |                            |                              |
| 128                  | 0,6mm  | 80°                  |               | Description          | SS-128-HS             | SS-128-C          | SDR-128-HS            | SDR-128-C         | SDL-128-HS            | SDL-128-C         | SM-128-HS                  | SF-128-HS                    |
|                      |        |                      |               | Tracking Data        | 96T / .0078"          | 96T / .0078"      | 96T / .0078"          | 96T / .0078"      | 96T / .0078"          | 96T / .0078"      | 96T / .0078"               | 96T / .0078"                 |
| Full Faced           | 26826  | -                    | -             | -                    | -                     | -                 | 27258                 |                   |                       |                   |                            |                              |
| Beveled              | -      | -                    | -             | -                    | -                     | -                 | -                     |                   |                       |                   |                            |                              |
| 160                  | 0,5mm  | 80°                  | Description   | SS-160-HS            | SS-160-C              | SDR-160-HS        | SDR-160-C             | SDL-160-HS        | SDL-160-C             | SM-160-HS         | SF-160-HS                  |                              |
|                      |        |                      | Tracking Data | 120T / .0063"        | 120T / .0063"         | 120T / .0063"     | 120T / .0063"         | 120T / .0063"     | 120T / .0063"         | 120T / .0063"     | 120T / .0063"              |                              |
| Full Faced           | -      | -                    | -             | 27012                | -                     | 27136             | -                     |                   |                       |                   |                            |                              |
| Beveled              | 26859  | -                    | -             | -                    | -                     | -                 | -                     |                   |                       |                   |                            |                              |

**SW2 Series**

For knurl cutting, use full faced knurl wheels only.

For End Feed form knurling, use beveled knurl wheels only.

For In Feed form knurling, beveled or full faced may be used.

"SW" knurling wheels are technically designed to knurl against a square shoulder.

With super precise workmanship, the wheels are made of heat treated High Speed and Cobalt steel to withstand severe knurling operation.

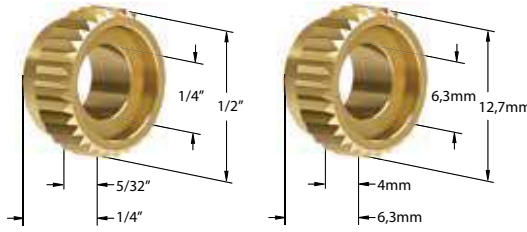

Knurl wheels are TiN coated to reduce the co-efficient of friction when knurling, increasing the quality and the force of knurling as well as the life of the knurl wheels.



Full Faced Beveled

| Circular Knurl Pitch   |        | Included Tooth Angle | Knurl Pattern | SW2 Series Knurl Wheel | Straight              |                   | Diagonal Right        |                   | Diagonal Left         |                   | Diamond                      |                          |
|------------------------|--------|----------------------|---------------|------------------------|-----------------------|-------------------|-----------------------|-------------------|-----------------------|-------------------|------------------------------|--------------------------|
| Inch                   | Metric |                      |               |                        | High Speed TiN Coated | Cobalt TiN Coated | High Speed TiN Coated | Cobalt TiN Coated | High Speed TiN Coated | Cobalt TiN Coated | Female High Speed TiN Coated | Female Cobalt TiN Coated |
| 16 (TPI)               | 1,6mm  | 90°                  | Coarse        | Description            | SW2S-16-HS            | SW2S-16-C         | SW2R-16-HS            | SW2R-16-C         | SW2L-16-HS            | SW2L-16-C         | SW2F-16-HS                   | SW2F-16-C                |
|                        |        |                      |               | Tracking Data          | 25T / .0204"          | 25T / .0204"      | 22T / .0232"          | 22T / .0232"      | 22T / .0232"          | 22T / .0232"      | 22T / .0232"                 | 22T / .0232"             |
|                        |        |                      |               | Full Faced             | 27401                 | 27402             | -                     | -                 | 27501                 | -                 | 27551                        | -                        |
|                        |        |                      |               | Beveled                | -                     | -                 | -                     | -                 | 27526                 | -                 | -                            | -                        |
| 20 (TPI)               | 1,2mm  | 90°                  | Medium        | Description            | SW2S-20-HS            | SW2S-20-C         | SW2R-20-HS            | SW2R-20-C         | SW2L-20-HS            | SW2L-20-C         | SW2F-20-HS                   | SW2F-20-C                |
|                        |        |                      |               | Tracking Data          | 31T / .0164"          | 31T / .0164"      | 27T / .0188"          | 27T / .0188"      | 27T / .0188"          | 27T / .0188"      | 27T / .0188"                 | 27T / .0188"             |
|                        |        |                      |               | Full Faced             | 27403                 | 27404             | 27453                 | 27454             | 27503                 | 27504             | -                            | -                        |
|                        |        |                      |               | Beveled                | 27428                 | 27429             | 27478                 | 27479             | 27528                 | 27529             | -                            | -                        |
| 25 (TPI)               | 1,0mm  | 90°                  | Medium        | Description            | SW2S-25-HS            | SW2S-25-C         | SW2R-25-HS            | SW2R-25-C         | SW2L-25-HS            | SW2L-25-C         | SW2F-25-HS                   | SW2F-25-C                |
|                        |        |                      |               | Tracking Data          | 38T / .0133"          | 38T / .0133"      | 34T / .0149"          | 34T / .0149"      | 34T / .0149"          | 34T / .0149"      | 34T / .0149"                 | 34T / .0149"             |
|                        |        |                      |               | Full Faced             | 27405                 | 27406             | -                     | -                 | 27505                 | 27506             | 27555                        | -                        |
|                        |        |                      |               | Beveled                | 27430                 | 27431             | 27480                 | 27481             | 27530                 | 27531             | -                            | -                        |
| 30 (TPI)               | 0,8mm  | 90°                  | Medium        | Description            | SW2S-30-HS            | SW2S-30-C         | SW2R-30-HS            | SW2R-30-C         | SW2L-30-HS            | SW2L-30-C         | SW2F-30-HS                   | SW2F-30-C                |
|                        |        |                      |               | Tracking Data          | 47T / .0107"          | 47T / .0107"      | 40T / .0126"          | 40T / .0126"      | 40T / .0126"          | 40T / .0126"      | 40T / .0126"                 | 40T / .0126"             |
|                        |        |                      |               | Full Faced             | 27407                 | 27408             | 27457                 | 27458             | 27507                 | 27508             | 27557                        | -                        |
|                        |        |                      |               | Beveled                | 27432                 | 27433             | 27482                 | 27483             | 27532                 | 27533             | -                            | -                        |
| 35 (TPI)               | 0,7mm  | 90°                  | Fine          | Description            | SW2S-35-HS            | SW2S-35-C         | SW2R-35-HS            | SW2R-35-C         | SW2L-35-HS            | SW2L-35-C         | SW2F-35-HS                   | SW2F-35-C                |
|                        |        |                      |               | Tracking Data          | 55T / .0092"          | 55T / .0092"      | 47T / .0107"          | 47T / .0107"      | 47T / .0107"          | 47T / .0107"      | 47T / .0107"                 | 47T / .0107"             |
|                        |        |                      |               | Full Faced             | -                     | 27410             | 27459                 | -                 | 27509                 | -                 | -                            | -                        |
|                        |        |                      |               | Beveled                | -                     | 27435             | -                     | -                 | -                     | -                 | -                            |                          |
| 40 (TPI)               | 0,6mm  | 90°                  | Fine          | Description            | SW2S-40-HS            | SW2S-40-C         | SW2R-40-HS            | SW2R-40-C         | SW2L-40-HS            | SW2L-40-C         | SW2F-40-HS                   | SW2F-40-C                |
|                        |        |                      |               | Tracking Data          | 63T / .0080"          | 63T / .0080"      | 55T / .0092"          | 55T / .0092"      | 55T / .0092"          | 55T / .0092"      | 55T / .0092"                 | 55T / .0092"             |
|                        |        |                      |               | Full Faced             | 27411                 | 27412             | -                     | -                 | -                     | -                 | 27561                        | -                        |
|                        |        |                      |               | Beveled                | -                     | 27437             | -                     | -                 | -                     | -                 | -                            |                          |
| 50 (TPI)               | 0,5mm  | 70°                  | Fine          | Description            | SW2S-50-HS            | SW2S-50-C         | SW2R-50-HS            | SW2R-50-C         | SW2L-50-HS            | SW2L-50-C         | SW2F-50-HS                   | SW2F-50-C                |
|                        |        |                      |               | Tracking Data          | 79T / .0064"          | 79T / .0064"      | 68T / .0074"          | 68T / .0074"      | 68T / .0074"          | 68T / .0074"      | 68T / .0074"                 | 68T / .0074"             |
|                        |        |                      |               | Full Faced             | -                     | -                 | -                     | -                 | -                     | -                 | 27563                        | -                        |
|                        |        |                      |               | Beveled                | -                     | 27439             | -                     | -                 | -                     | -                 | -                            |                          |
| <b>Diametral Pitch</b> |        |                      |               |                        |                       |                   |                       |                   |                       |                   |                              |                          |
| 64                     | 1,2mm  | 80°                  | Medium        | Description            | SW2S-64-HS            | SW2S-64-C         | SW2R-64-HS            | SW2R-64-C         | SW2L-64-HS            | SW2L-64-C         | SW2F-64-HS                   | SW2F-64-C                |
|                        |        |                      |               | Tracking Data          | 32T / .0156"          | 32T / .0156"      | 32T / .0156"          | 32T / .0156"      | 32T / .0156"          | 32T / .0156"      | 32T / .0156"                 | 32T / .0156"             |
|                        |        |                      |               | Full Faced             | -                     | -                 | -                     | -                 | -                     | -                 | -                            | -                        |
|                        |        |                      |               | Beveled                | -                     | -                 | 27490                 | -                 | 27540                 | -                 | -                            | -                        |
| 96                     | 0,8mm  | 80°                  | Medium        | Description            | SW2S-96-HS            | SW2S-96-C         | SW2R-96-HS            | SW2R-96-C         | SW2L-96-HS            | SW2L-96-C         | SW2F-96-HS                   | SW2F-96-C                |
|                        |        |                      |               | Tracking Data          | 48T / .0104"          | 48T / .0104"      | 48T / .0104"          | 48T / .0104"      | 48T / .0104"          | 48T / .0104"      | 48T / .0104"                 | 48T / .0104"             |
|                        |        |                      |               | Full Faced             | 27417                 | -                 | 27467                 | 27468             | 27517                 | 27518             | 27567                        | -                        |
|                        |        |                      |               | Beveled                | 27442                 | -                 | 27493                 | -                 | 27543                 | -                 | -                            |                          |
| 128                    | 0,6mm  | 80°                  | Fine          | Description            | SW2S-128-HS           | SW2S-128-C        | SW2R-128-HS           | SW2R-128-C        | SW2L-128-HS           | SW2L-128-C        | SW2F-128-HS                  | SW2F-128-C               |
|                        |        |                      |               | Tracking Data          | 64T / .0078"          | 64T / .0078"      | 64T / .0078"          | 64T / .0078"      | 64T / .0078"          | 64T / .0078"      | 64T / .0078"                 | 64T / .0078"             |
|                        |        |                      |               | Full Faced             | 27419                 | -                 | 27469                 | -                 | 27519                 | -                 | -                            | -                        |
|                        |        |                      |               | Beveled                | -                     | -                 | -                     | -                 | -                     | -                 | -                            |                          |
| 160                    | 0,5mm  | 80°                  | Fine          | Description            | SW2S-160-HS           | SW2S-160-C        | SW2R-160-HS           | SW2R-160-C        | SW2L-160-HS           | SW2L-160-C        | SW2F-160-HS                  | SW2F-160-C               |
|                        |        |                      |               | Tracking Data          | 80T / .0063"          | 80T / .0063"      | 80T / .0063"          | 80T / .0063"      | 80T / .0063"          | 80T / .0063"      | 80T / .0063"                 | 80T / .0063"             |
|                        |        |                      |               | Full Faced             | -                     | -                 | -                     | -                 | -                     | -                 | -                            | -                        |
|                        |        |                      |               | Beveled                | -                     | -                 | -                     | -                 | -                     | -                 | -                            |                          |

## SW4 Series

For knurl cutting, use full faced knurl wheels only.

For end-feed form knurling, use beveled knurl wheels only.

For in-feed form knurling, beveled or full faced may be used.

"SW" Knurl Wheels are technically designed to knurl against a square shoulder.

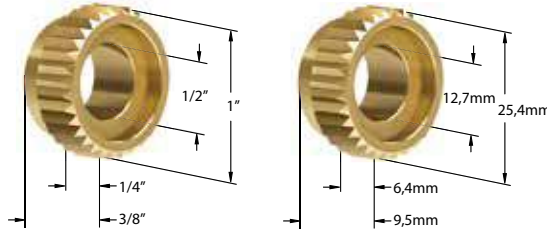

Knurl wheels are TiN coated to reduce the coefficient of friction when knurling, increasing the quality and the force of knurling as well as the life of the knurl wheels.



Full Faced Beveled

| Circular Knurl Pitch |                       | Included Tooth Angle  | Knurl Pattern         | SW4 Series Knurl Wheel | Straight              |                       | Diagonal Right        |                       | Diagonal Left         |                   | Diamond                      |                          |
|----------------------|-----------------------|-----------------------|-----------------------|------------------------|-----------------------|-----------------------|-----------------------|-----------------------|-----------------------|-------------------|------------------------------|--------------------------|
| Inch                 | Metric                |                       |                       |                        | High Speed TiN Coated | Cobalt TiN Coated     | High Speed TiN Coated | Cobalt TiN Coated     | High Speed TiN Coated | Cobalt TiN Coated | Female High Speed TiN Coated | Female Cobalt TiN Coated |
| 14 (TPI)             | 1,8mm                 | 90°                   | Coarse                | Description            | SW4S-14-HS            | SW4S-14-C             | SW4R-14-HS            | SW4R-14-C             | SW4L-14-HS            | SW4L-14-C         | SW4F-14-HS                   | SW4F-14-C                |
|                      |                       |                       |                       | Tracking Data          | 44T / .0230"          | 44T / .0230"          | 38T / .0266"          | 38T / .0266"          | 38T / .0266"          | 38T / .0266"      | 38T / .0266"                 | 38T / .0266"             |
| Full Faced           | <a href="#">28001</a> | <a href="#">28002</a> |                       | <a href="#">28055</a>  | <a href="#">28056</a> | <a href="#">28109</a> | <a href="#">28110</a> | <a href="#">28163</a> | -                     |                   |                              |                          |
| Beveled              | <a href="#">28028</a> | <a href="#">28029</a> |                       | <a href="#">28082</a>  | <a href="#">28083</a> | <a href="#">28136</a> | <a href="#">28137</a> | -                     | -                     |                   |                              |                          |
| 16 (TPI)             | 1,6mm                 | 90°                   | Description           | SW4S-16-HS             | SW4S-16-C             | SW4R-16-HS            | SW4R-16-C             | SW4L-16-HS            | SW4L-16-C             | SW4F-16-HS        | SW4F-16-C                    |                          |
|                      |                       |                       | Tracking Data         | 50T / .0202"           | 50T / .0202"          | 45T / .0224"          | 45T / .0224"          | 45T / .0224"          | 45T / .0224"          | 45T / .0224"      | 45T / .0224"                 | 45T / .0224"             |
| Standard             | <a href="#">28003</a> | <a href="#">28004</a> | <a href="#">28057</a> | <a href="#">28058</a>  | 28111                 | 28112                 | 28165                 | <a href="#">28166</a> |                       |                   |                              |                          |
| Bevel                | <a href="#">28030</a> | <a href="#">28031</a> | <a href="#">28084</a> | <a href="#">28085</a>  | <a href="#">28138</a> | <a href="#">28139</a> | -                     | <a href="#">28193</a> |                       |                   |                              |                          |
| 20 (TPI)             | 1,2mm                 | 90°                   | Description           | SW4S-20-HS             | SW4S-20-C             | SW4R-20-HS            | SW4R-20-C             | SW4L-20-HS            | SW4L-20-C             | SW4F-20-HS        | SW4F-20-C                    |                          |
|                      |                       |                       | Tracking Data         | 61T / .0165"           | 61T / .0165"          | 54T / .0187"          | 54T / .0187"          | 54T / .0187"          | 54T / .0187"          | 54T / .0187"      | 54T / .0187"                 | 54T / .0187"             |
| Full Faced           | <a href="#">28005</a> | <a href="#">28006</a> | <a href="#">28059</a> | <a href="#">28060</a>  | 28113                 | 28114                 | 28167                 | <a href="#">28168</a> |                       |                   |                              |                          |
| Beveled              | <a href="#">28032</a> | <a href="#">28033</a> | <a href="#">28086</a> | <a href="#">28087</a>  | <a href="#">28140</a> | <a href="#">28141</a> | -                     | <a href="#">28195</a> |                       |                   |                              |                          |
| 25 (TPI)             | 1,0mm                 | 90°                   | Description           | SW4S-25-HS             | SW4S-25-C             | SW4R-25-HS            | SW4R-25-C             | SW4L-25-HS            | SW4L-25-C             | SW4F-25-HS        | SW4F-25-C                    |                          |
|                      |                       |                       | Tracking Data         | 78T / .0129"           | 78T / .0129"          | 68T / .0148"          | 68T / .0148"          | 68T / .0148"          | 68T / .0148"          | 68T / .0148"      | 68T / .0148"                 | 68T / .0148"             |
| Full Faced           | <a href="#">28007</a> | <a href="#">28008</a> | <a href="#">28061</a> | <a href="#">28062</a>  | 28115                 | 28116                 | -                     | -                     |                       |                   |                              |                          |
| Beveled              | <a href="#">28034</a> | <a href="#">28035</a> | <a href="#">28088</a> | <a href="#">28089</a>  | <a href="#">28142</a> | <a href="#">28143</a> | -                     | -                     |                       |                   |                              |                          |
| 30 (TPI)             | 0,8mm                 | 90°                   | Description           | SW4S-30-HS             | SW4S-30-C             | SW4R-30-HS            | SW4R-30-C             | SW4L-30-HS            | SW4L-30-C             | SW4F-30-HS        | SW4F-30-C                    |                          |
|                      |                       |                       | Tracking Data         | 95T / .0106"           | 95T / .0106"          | 81T / .0124"          | 81T / .0124"          | 81T / .0124"          | 81T / .0124"          | 81T / .0124"      | 81T / .0124"                 | 81T / .0124"             |
| Full Faced           | <a href="#">28009</a> | <a href="#">28010</a> | <a href="#">28063</a> | <a href="#">28064</a>  | 28117                 | 28118                 | -                     | -                     |                       |                   |                              |                          |
| Beveled              | <a href="#">28036</a> | <a href="#">28037</a> | <a href="#">28090</a> | <a href="#">28091</a>  | <a href="#">28144</a> | <a href="#">28145</a> | -                     | -                     |                       |                   |                              |                          |
| 35 (TPI)             | 0,7mm                 | 90°                   | Description           | SW4S-35-HS             | SW4S-35-C             | SW4R-35-HS            | SW4R-35-C             | SW4L-35-HS            | SW4L-35-C             | SW4F-35-HS        | SW4F-35-C                    |                          |
|                      |                       |                       | Tracking Data         | 110T / .0091"          | 110T / .0091"         | 95T / .0106"          | 95T / .0106"          | 95T / .0106"          | 95T / .0106"          | 95T / .0106"      | 95T / .0106"                 | 95T / .0106"             |
| Full Faced           | -                     | <a href="#">28012</a> | -                     | <a href="#">28066</a>  | -                     | <a href="#">28120</a> | -                     | -                     |                       |                   |                              |                          |
| Beveled              | -                     | -                     | -                     | 28093                  | -                     | 28147                 | -                     | -                     |                       |                   |                              |                          |
| 40 (TPI)             | 0,6mm                 | 90°                   | Description           | SW4S-40-HS             | SW4S-40-C             | SW4R-40-HS            | SW4R-40-C             | SW4L-40-HS            | SW4L-40-C             | SW4F-40-HS        | SW4F-40-C                    |                          |
|                      |                       |                       | Tracking Data         | 124T / .0081"          | 124T / .0081"         | 108T / .0093"         | 108T / .0093"         | 108T / .0093"         | 108T / .0093"         | 108T / .0093"     | 108T / .0093"                | 108T / .0093"            |
| Full Faced           | <a href="#">28013</a> | <a href="#">28014</a> | -                     | <a href="#">28068</a>  | -                     | <a href="#">28122</a> | -                     | -                     |                       |                   |                              |                          |
| Beveled              | <a href="#">28040</a> | <a href="#">28041</a> | -                     | -                      | -                     | -                     | -                     | -                     |                       |                   |                              |                          |
| 50 (TPI)             | 0,5mm                 | 70°                   | Description           | SW4S-50-HS             | SW4S-50-C             | SW4R-50-HS            | SW4R-50-C             | SW4L-50-HS            | SW4L-50-C             | SW4F-50-HS        | SW4F-50-C                    |                          |
|                      |                       |                       | Tracking Data         | 158T / .0063"          | 158T / .0063"         | 135T / .0074"         | 135T / .0074"         | 135T / .0074"         | 135T / .0074"         | 135T / .0074"     | 135T / .0074"                | 135T / .0074"            |
| Standard             | -                     | -                     | -                     | <a href="#">28070</a>  | -                     | <a href="#">28124</a> | -                     | -                     |                       |                   |                              |                          |
| Bevel                | -                     | -                     | -                     | -                      | -                     | -                     | -                     | -                     |                       |                   |                              |                          |
| Diametral Pitch      |                       |                       |                       |                        |                       |                       |                       |                       |                       |                   |                              |                          |
| 64                   | 1,2mm                 | 80°                   | Medium                | Description            | SW4S-64-HS            | SW4S-64-C             | SW4R-64-HS            | SW4R-64-C             | SW4L-64-HS            | SW4L-64-C         | SW4F-64-HS                   | SW4F-64-C                |
|                      |                       |                       |                       | Tracking Data          | 64T / .0156"          | 64T / .0156"          | 64T / .0156"          | 64T / .0156"          | 64T / .0156"          | 64T / .0156"      | 64T / .0156"                 | 64T / .0156"             |
| Full Faced           | <a href="#">28017</a> | 28018                 |                       | -                      | -                     | -                     | -                     | -                     | -                     |                   |                              |                          |
| Beveled              | <a href="#">28044</a> | <a href="#">28045</a> |                       | -                      | -                     | -                     | -                     | -                     | -                     |                   |                              |                          |
| 96                   | 0,8mm                 | 80°                   | Description           | SW4S-96-HS             | SW4S-96-C             | SW4R-96-HS            | SW4R-96-C             | SW4L-96-HS            | SW4L-96-C             | SW4F-96-HS        | SW4F-96-C                    |                          |
|                      |                       |                       | Tracking Data         | 96T / .0104"           | 96T / .0104"          | 96T / .0104"          | 96T / .0104"          | 96T / .0104"          | 96T / .0104"          | 96T / .0104"      | 96T / .0104"                 | 96T / .0104"             |
| Full Faced           | <a href="#">28019</a> | <a href="#">28020</a> | -                     | <a href="#">28074</a>  | -                     | <a href="#">28128</a> | -                     | <a href="#">28181</a> |                       |                   |                              |                          |
| Beveled              | <a href="#">28046</a> | <a href="#">28047</a> | -                     | <a href="#">28101</a>  | -                     | <a href="#">28155</a> | -                     | -                     |                       |                   |                              |                          |

**CNC Modular Knurling Tool Adjustment Screw**

| Description | UPC #                 | Reference Knurling Tool    |
|-------------|-----------------------|----------------------------|
| CNC-1175    | <a href="#">28505</a> | CNC Modular Knurling Tool  |
| SCNC-875    | <a href="#">28510</a> | SCNC Modular Knurling Tool |

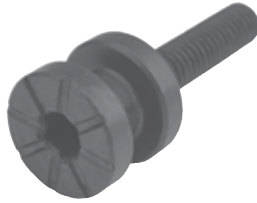

**CNC Modular Knurling Tool Lock Screw**

| Description | UPC #                 | Reference Knurling Tool    |
|-------------|-----------------------|----------------------------|
| CNC-1024*   | <a href="#">28515</a> | CNC Modular Knurling Tool  |
| SCNC-832    | <a href="#">28520</a> | SCNC Modular Knurling Tool |



\*Set of three (3) lock screws

**Spring & Ball Plunger For Self-Centering Knurl Tools**

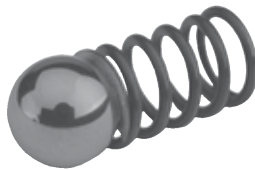

| Description | UPC #                 | Reference Knurling Tool   |
|-------------|-----------------------|---|
| STBL-18     | <a href="#">28525</a> | 3SHKT-50-D, 3SHKT-162-D<br>3SHKT-12-D, 3SHKT-162-D<br>SCKN-38-DW-D, SCKN-50-DWD, SCKN-162-DW-D<br>SCKN-10-DW-D, SCKN-12-DWD, SCKN-162-DW-D<br>SSCK-38-DW-2, SSCK-50-DW-2, SSCK-162-DW-2<br>SSCK-10-DW-2, SSCK-12-DW-2, SSCK-162-DW-2  |
| STBL-25     | <a href="#">28530</a> | 3SHKT-75-M, 3SHKT-100-M, 3SHKT-125-M<br>3SHKT-20-M, 3SHKT-25-M, 3SHKT-32-M<br>SCKN-75-DW-M, SCKN-100-DW-M, SCKN-125-DW-M<br>HDSCKN-75-DW-O, HDSCKN-100-DW-O,<br>HDSCKN-100-DW-P, HDSCKN-125-DW-P<br>SCKN-20-DW-M, SCKN-25-DW-M, SCKN-32-DW-M<br>HDSCKN-20-DW-O, HDSCKN-25-DW-O,<br>HDSCKN-25-DW-P, HDSCKN-32-DW-P<br>SSCK-75-DW-4, SSCK-100-DW-4, SSCK-125-DW-4<br>SSCK-20-DW-4, SSCK-25-DW-4, SSCK-32-DW-4 |

**KPS Series Knurling Pin Set**

| High Speed  |                       | Carbide      |                       | D (inch) | L (inch) |
|-------------|-----------------------|--------------|-----------------------|----------|----------|
| Description | UPC #                 | Description  | UPC #                 |          |          |
| KPS-12-38   | <a href="#">28800</a> | KPS-12-38-C  | <a href="#">28900</a> | 1/8      | 3/8      |
| KPS-18-50   | <a href="#">28805</a> | KPS-18-50-C  | <a href="#">28905</a> | 3/16     | 1/2      |
| KPS-18-62   | <a href="#">28810</a> | KPS-18-62-C  | <a href="#">28910</a> | 3/16     | 5/8      |
| KPS-25-62   | <a href="#">28815</a> | KPS-25-62-C  | <a href="#">28915</a> | 1/4      | 5/8      |
| KPS-25-75   | <a href="#">28820</a> | KPS-25-75-C  | <a href="#">28920</a> | 1/4      | 3/4      |
| KPS-25-87   | <a href="#">28825</a> | KPS-25-87-C  | <a href="#">28925</a> | 1/4      | 7/8      |
| KPS-25-100  | <a href="#">28830</a> | KPS-25-100-C | <a href="#">28930</a> | 1/4      | 1.0      |
| KPS-25-125  | <a href="#">28835</a> | KPS-25-125-C | <a href="#">28935</a> | 1/4      | 1-1/4    |
| KPS-31-75   | <a href="#">28840</a> | KPS-31-75-C  | <a href="#">28940</a> | 5/16     | 3/4      |
| KPS-31-100  | <a href="#">28845</a> | KPS-31-100-C | <a href="#">28945</a> | 5/16     | 1.0      |
| KPS-31-125  | <a href="#">28850</a> | KPS-31-125-C | <a href="#">28950</a> | 5/16     | 1-1/4    |
| KPS-50-125  | <a href="#">28855</a> | KPS-50-125-C | <a href="#">28955</a> | 1/2      | 1-1/4    |
| KPS-50-150  | <a href="#">28860</a> | KPS-50-150-C | <a href="#">28960</a> | 1/2      | 1-1/2    |



**SW Series Knurling Pin Set**

| High Speed   |                       | D (inch) | L (inch) |
|--------------|-----------------------|----------|----------|
| Description  | UPC #                 |          |          |
| SW2.0P-1S*   | <a href="#">29050</a> | 1/4      | 1/2      |
| SW2.0P-2S**  | <a href="#">29055</a> |          |          |
| SW2.0P-3S*** | <a href="#">29060</a> |          |          |
| SW4.0P-1S*   | <a href="#">29080</a> | 1/2      | 1-1/8    |
| SW4.0P-2S**  | <a href="#">29085</a> |          |          |
| SW4.0P-3S*** | <a href="#">29090</a> |          |          |

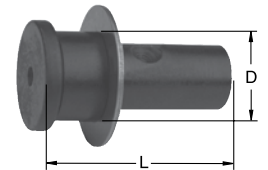

\* Set of one (1) pin and washer  
 \*\* Set of two (2) pins and washers  
 \*\*\* Set of three (3) pins and washers

**SW Series Knurling Pin Set Cobalt**

| Cobalt          |                       | D (inch) | L (inch) |
|-----------------|-----------------------|----------|----------|
| Description     | UPC #                 |          |          |
| SW2.0P-CO-1S*   | <a href="#">30003</a> | 1/4      | 1/2      |
| SW2.0P-CO-2S**  | <a href="#">30004</a> |          |          |
| SW2.0P-CO-3S*** | <a href="#">30005</a> |          |          |
| SW4.0P-CO-1S*   | <a href="#">30009</a> | 1/2      | 1-1/8    |
| SW4.0P-CO-2S**  | <a href="#">30010</a> |          |          |
| SW4.0P-CO-3S*** | <a href="#">30011</a> |          |          |

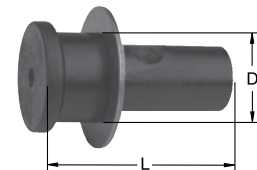

\* Set of one (1) pin and washer  
 \*\* Set of two (2) pins and washers  
 \*\*\* Set of three (3) pins and washers

## Linear Measurement

1 foot = 12 inches  
1 yard = 3 feet  
1 yard = 36 inches  
1 mile = 1,760 yards  
1 mile = 5,280 feet  
1 mile = 63,360 inches  
1 light year = 5.879 trillion miles

1 inch = 2.540 centimeters  
1 foot = .3048 meters  
1 yard = .9144 meters  
1 mile = 1.609 kilometers  
1 centimeter = .3937 inches  
1 meter = 3.281 feet  
1 meter = 1.094 yards  
1 kilometer = .6214 miles

1 kilometer = 1000 meters  
1 hectometer = 100 meters  
1 dekameter = 10 meters  
1 meter = 10 decimeters  
1 meter = 100 centimeters  
1 meter = 1000 millimeters  
1 light year = 9.46 trillion kilometers

## Square Measurement

1 sq. foot = 144 sq. inches  
1 sq. yard = 9 sq. feet  
1 sq. yard = 1,296 sq. inches  
1 sq. mile = 3,097,600 sq. yards  
1 sq. mile = 27,878,400 sq. feet  
1 sq. mile = 4,014,489,600 sq. inches  
1 acre = 4,840 sq. yards  
1 acre = 43,560 sq. feet  
1 acre = 6,272,640 sq. inches

1 sq. inch = 6.452 sq. centimeters  
1 sq. foot = .09290 sq. meters  
1 sq. yard = .8361 sq. meters  
1 sq. mile = 2.590 sq. kilometers  
1 sq. centimeter = .155 sq. inches  
1 sq. kilometer = 247.1 acres  
1 sq. kilometer = .3861 sq. miles  
1 sq. meter = 10.76 sq. feet  
1 sq. meter = 1.196 sq. yards

1 sq. kilometer = 1,000,000 sq. meters  
1 sq. hectometer = 10,000 sq. meters  
1 sq. dekameter = 100 sq. meters  
1 sq. meter = 100 sq. decimeters  
1 sq. meter = 10,000 sq. centimeters  
1 sq. meter = 1,000,000 sq. millimeters

## Cubic Measurement

1 cu. foot = 1,728 cu. inches  
1 cu. yard = 27 cu. feet  
1 cu. yard = 46,656 cu. inches

1 cu. inch = 16.39 cu. centimeters  
1 cu. foot = 28,320 cu. centimeters  
1 cu. foot = .02832 cu. meters  
1 cu. yard = 764,600 cu. centimeters  
1 cu. yard = .7646 cu. meters  
1 cu. centimeter = .06102 cu. inches  
1 cu. meter = 35.31 cu. feet  
1 cu. meter = 61,023 cu. inches  
1 cu. meter = 1.308 cu. yards

1 cu. kilometer = 1,000,000,000 cu. meters  
1 cu. hectometer = 1,000,000 cu. meters  
1 cu. dekameter = 1,000 cu. meters  
1 cu. meter = 1,000 cu. decimeters  
1 cu. meter = 1,000,000 cu. centimeters  
1 cu. meter = 1,000,000,000 cu. millimeters

## Weight Measurements

1 pound = 16 ounces  
1 ton = 2000 pounds  
1 ton = 32,000 ounces

1 ounce = 28.349527 grams  
1 pound = .4536 kilograms  
1 english ton = .90718 metric tons  
1 gram = .03527 ounces  
1 kilogram = 2.205 pounds  
1 metric ton = .98421 english tons

1 kilogram = 1000 grams  
1 hectogram = 100 grams  
1 dekagram = 10 grams  
1 gram = 10 decigrams  
1 gram = 100 centigrams  
1 gram = 1000 milligrams

## Fluid Volume Measurements

1 gallon = 4 quarts  
1 gallon = 8 pints  
1 gallon = 16 cups  
1 gallon = 256 liquid ounces  
1 quart = 2 pints  
1 quart = 4 cups  
1 quart = 64 liquid ounces  
1 pint = 2 cups  
1 pint = 16 liquid ounces  
1 cup = 8 liquid ounces

1 gallon = 3.785 liters

1 quart = .9463 liters  
1 pint = .4732 liters  
1 liter = .2642 gallons  
1 liter = 1.057 quarts  
1 liter = 2.113 pints

1 kiloliter = 1000 liters  
1 hectoliter = 100 liters  
1 dekaliter = 10 liters  
1 liter = 10 deciliters  
1 liter = 100 centiliters  
1 liter = 1000 milliliters

## Temperature Conversions

To convert Fahrenheit degrees into Celsius, subtract 32, multiply by .5556.

To convert Celsius into Fahrenheit, multiply by 1.8 and add 32.

## Speeds

1 mile/hour = 88 feet/minute  
1 mile/hour = 1.467 feet/second  
1 mile/hour = 1.609 kilometers/hour  
1 miles/hour = 44.70 centimeters/second  
1 foot/minute = .0113636 miles/hour  
1 foot/second = 30.48 centimeters/second  
1 foot/second = .6818 miles/hour  
1 centimeter/second = .3281 feet/second  
speed of sound = 742 miles/hour in air  
speed of sound = 1,193.9 kilometers/hour  
speed of light = 186,295 miles/second  
speed of light = 299,748 kilometers/second

## Time

1 minute = 60 seconds  
1 hour = 60 minutes  
1 hour = 3,600 seconds  
1 day = 24 hours  
1 day = 1,440 minutes  
1 day = 86,400 seconds  
1 week = 7 days  
1 week = 168 hours  
1 week = 10,080 minutes  
1 week = 604,800 seconds  
1 year = 12 months  
1 year = 52 weeks  
1 year = 365 days 6 hours  
1 year = 8,766 hours  
1 year = 525,960 minutes  
1 year = 31,557,600 seconds

**From Inch to Metric Formula**

| Inch Value |   | Metric Value |          |
|------------|---|--------------|----------|
| 1.000      | x | 25.4         | = 25.400 |
| 1.000      | ÷ | 0.03937      | = 25.400 |

**From Metric to Inch Formula**

| Metric Value |   | Inch Value |           |
|--------------|---|------------|-----------|
| 1.000        | ÷ | 25.4       | = 0.03937 |
| 1.000        | x | 0.03937    | = 0.03937 |

**From Inch to Metric Values**

| Inch    |   | Millimeter |            |
|---------|---|------------|------------|
| 0.00001 | x | 25.4       | = 0.000254 |
| 0.0001  | x | 25.4       | = 0.00254  |
| 0.001   | x | 25.4       | = 0.0254   |
| 0.01    | x | 25.4       | = 0.254    |
| 0.1     | x | 25.4       | = 2.54     |

**From Metric to Inch Values**

| Millimeter |   | Inch |              |
|------------|---|------|--------------|
| 0.00001    | ÷ | 25.4 | = 0.00000039 |
| 0.0001     | ÷ | 25.4 | = 0.0000039  |
| 0.001      | ÷ | 25.4 | = 0.000039   |
| 0.01       | ÷ | 25.4 | = 0.00039    |
| 0.1        | ÷ | 25.4 | = 0.00394    |

|       |   |      |   |        |
|-------|---|------|---|--------|
| 1.00  | x | 25.4 | = | 25.40  |
| 1.125 | x | 25.4 | = | 28.58  |
| 1.250 | x | 25.4 | = | 31.75  |
| 1.375 | x | 25.4 | = | 34.93  |
| 1.500 | x | 25.4 | = | 38.10  |
| 1.625 | x | 25.4 | = | 41.28  |
| 1.750 | x | 25.4 | = | 44.45  |
| 1.875 | x | 25.4 | = | 47.63  |
| 2.00  | x | 25.4 | = | 50.80  |
| 3.00  | x | 25.4 | = | 76.20  |
| 4.00  | x | 25.4 | = | 101.60 |
| 5.00  | x | 25.4 | = | 127.00 |
| 6.00  | x | 25.4 | = | 152.40 |
| 7.00  | x | 25.4 | = | 177.80 |
| 8.00  | x | 25.4 | = | 203.20 |
| 9.00  | x | 25.4 | = | 228.60 |
| 10.00 | x | 25.4 | = | 254.00 |

|     |   |      |   |        |
|-----|---|------|---|--------|
| 1   | ÷ | 25.4 | = | 0.0394 |
| 1.1 | ÷ | 25.4 | = | 0.0433 |
| 1.2 | ÷ | 25.4 | = | 0.0472 |
| 1.3 | ÷ | 25.4 | = | 0.0512 |
| 1.4 | ÷ | 25.4 | = | 0.0551 |
| 1.5 | ÷ | 25.4 | = | 0.0591 |
| 1.6 | ÷ | 25.4 | = | 0.0630 |
| 1.7 | ÷ | 25.4 | = | 0.0669 |
| 1.8 | ÷ | 25.4 | = | 0.0709 |
| 1.9 | ÷ | 25.4 | = | 0.0748 |
| 2   | ÷ | 25.4 | = | 0.0787 |
| 3   | ÷ | 25.4 | = | 0.1181 |
| 4   | ÷ | 25.4 | = | 0.1575 |
| 5   | ÷ | 25.4 | = | 0.1969 |
| 6   | ÷ | 25.4 | = | 0.2362 |
| 7   | ÷ | 25.4 | = | 0.2756 |
| 8   | ÷ | 25.4 | = | 0.3150 |
| 9   | ÷ | 25.4 | = | 0.3543 |
| 10  | ÷ | 25.4 | = | 0.3937 |

|       |   |      |   |        |
|-------|---|------|---|--------|
| 11.00 | x | 25.4 | = | 279.40 |
| 12.00 | x | 25.4 | = | 304.80 |
| 13.00 | x | 25.4 | = | 330.20 |
| 14.00 | x | 25.4 | = | 355.60 |
| 15.00 | x | 25.4 | = | 381.00 |
| 16.00 | x | 25.4 | = | 406.40 |
| 17.00 | x | 25.4 | = | 431.80 |
| 18.00 | x | 25.4 | = | 457.20 |
| 19.00 | x | 25.4 | = | 482.60 |
| 20.00 | x | 25.4 | = | 508.00 |
| 21.00 | x | 25.4 | = | 533.40 |
| 22.00 | x | 25.4 | = | 558.80 |
| 23.00 | x | 25.4 | = | 584.20 |
| 24.00 | x | 25.4 | = | 609.60 |
| 25.00 | x | 25.4 | = | 635.00 |

|    |   |      |   |        |
|----|---|------|---|--------|
| 11 | ÷ | 25.4 | = | 0.4331 |
| 12 | ÷ | 25.4 | = | 0.4724 |
| 13 | ÷ | 25.4 | = | 0.5118 |
| 14 | ÷ | 25.4 | = | 0.5512 |
| 15 | ÷ | 25.4 | = | 0.5906 |
| 16 | ÷ | 25.4 | = | 0.6299 |
| 17 | ÷ | 25.4 | = | 0.6693 |
| 18 | ÷ | 25.4 | = | 0.7087 |
| 19 | ÷ | 25.4 | = | 0.7480 |
| 20 | ÷ | 25.4 | = | 0.7874 |
| 21 | ÷ | 25.4 | = | 0.8268 |
| 22 | ÷ | 25.4 | = | 0.8661 |
| 23 | ÷ | 25.4 | = | 0.9055 |
| 24 | ÷ | 25.4 | = | 0.9449 |
| 25 | ÷ | 25.4 | = | 0.9843 |

|               |       |   |      |   |        |
|---------------|-------|---|------|---|--------|
| <b>1-Foot</b> | 12.00 | x | 25.4 | = | 304.80 |
| <b>1-Yard</b> | 36.00 | x | 25.4 | = | 914.40 |

|                     |      |   |      |   |         |
|---------------------|------|---|------|---|---------|
| <b>1-Meter</b>      | 1000 | ÷ | 25.4 | = | 39.3701 |
| <b>1-Decimeter</b>  | 100  | ÷ | 25.4 | = | 3.9370  |
| <b>1-Centimeter</b> | 10   | ÷ | 25.4 | = | 0.3937  |
| <b>1-Millimeter</b> | 1    | ÷ | 25.4 | = | 0.0394  |

## Safety Precautions & Product Hazards

This catalog contains information and specifications concerning knurling tools sold by Dorian Tool International. Although some of the Knurl Wheels are made from cobalt, are very tough and resist breakage, most are brittle and special safety precautions are required when using them. Small fragment and chips may be thrown from a knurling tool when a fracture occurs. Since these fragments or chips are thrown at very high speeds and are very hot, contact with the skin or eyes could cause severe injury. Also, the grinding of these cutting tools will produce fine cobalt dust which may be harmful to the lungs. Listed below are some suggestions on how to minimize the potential for injury while using knurling tools. Dorian Tool has no control over use of these knurling tools. The user must determine the suitability of these tools in its particular application.

**Warning:** Very hot chip fragments may be thrown from knurling tools at very high speeds. These chips can cause severe burns, cuts or punctures to the skin, or damage to the eyes. Along with safety glasses with side shields, the following are some of the safety precautions that must be followed by operators and observers while using knurling tools:

1. Make sure that the wheel size and style are adequate for use to which it is being put.
2. Chip control is necessary to prevent a continuous chip catching in the workpiece.
3. Chips are very hot and have sharp edges and should not be moved by hand.
4. Turn off the machine whenever chips are removed or when the knurling tools are changed.
5. Do not use air hoses to blow chips away from the machine.
6. To prevent tool breakage, use the correct size toolholder.
7. Make sure that the overhang on the knurl tool is as short as possible. Too much overhang can result in chatter and tool breakage.
8. To prevent the workpiece from coming loose during use, be sure the workpiece is tight and secure in its holder.
9. Overloading of cobalt knurl wheels may cause fractures of these wheels.

**Warning:** Grinding or finishing cobalt produces fine cobalt dust. This dust may cause injury to the lungs. Operators and observers must take the following safety precautions to minimize the possibility of such injury:

1. Use with adequate ventilation.
2. Maintain the dust or mist level below OSHA and ACGIH levels.
3. Avoid breathing dust or mist. If not possible, wear OSHA - approved respirators, particularly when grinding cobalt.
4. Minimize prolonged skin contact.
5. Wash hands thoroughly after handling.

1. Keep the cutting fluid clean so no particles can be carried back across the workpiece and possibly scratch it.
2. Cutting fluids may catch on fire when exposed to high temperatures generated during knurling.
3. Work materials such as aluminum, magnesium, uranium, and titanium are flammable and could catch on fire.
4. Cutting fluids should be treated or replaced to reduce bacterial levels which may cause illness.

