

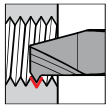

Cutting insert for internal threading, partial profile - UN-threads



• pitch 32-40 thread/inch

for tool holders type GH104/GB104 see from page 16

Cutting data page 148

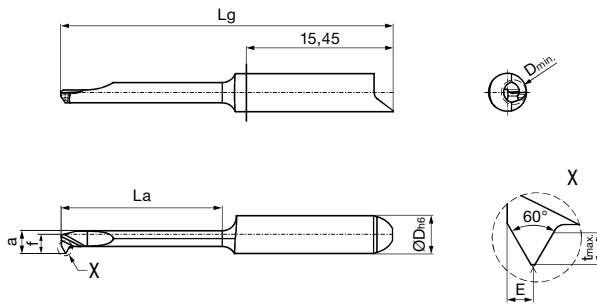

Right hand version shown
Left hand version mirror image

Tool material	Solid carbide		
Type	GG 104	GG 104	GG 104
Surface	S	a	○
	TiN	TiAlN-nanoA	bright

Series no.	25172	25174	25178
Cutting direction	(R)	(R)	(R)

Code no.	Description	P	D min	f	t max	a	E	La	Lg	D h6
		Thread/inch	mm	mm	mm	mm	mm	mm	mm	mm
4.001	GG104.TU32.040.17.26.R	32-40	2.60	1.95	0.55	2.35	0.45	17.00	35.00	4.00

Series no.	25173	25175	25179
Cutting direction	(L)	(L)	(L)

Code no.	Description	P	D min	f	t max	a	E	La	Lg	D h6
		Thread/inch	mm	mm	mm	mm	mm	mm	mm	mm
4.001	GG104.TU32.040.17.26.L	32-40	2.60	1.95	0.55	2.35	0.45	17.00	35.00	4.00



Machining	Feed range f (IPR)	Point radius R (mm)	Cutting depth ap (in)	General formulas
	0.0008 - 0.0031	R 0.05 (0.002in) R 0.10 (0.004in) R 0.15 (0.006in) R 0.20 (0.008in) R 0.25 (0.010in) R 0.30 (0.012in)	0.0008 - 0.0028 0.0020 - 0.0059 0.0031 - 0.0079 0.0047 - 0.0098 0.0051 - 0.0110 0.0067 - 0.0138	Cutting speed (SFM) RPM x Dia. / 3.82 = SFM
	0.0004 - 0.0012			Revolutions per minute (RPM) SFM x 3.82 / Dia. = RPM
	0.0004 - 0.0020		Rule of thumb: ap ~ r	Feed rate (IPM) IPR x RPM = IPM

Guide values for feed and cutting depths

ISO	Material	Material examples/ material number	Tensile strength (N/mm ²)	Brinell hardness (HB)	Cutting speed SFM (surface feet / min)			
					TiN \$	TiAlN nanoA P	Bright O	
P	Carbon steel	C ≤ 0.15 %	11SMn30+C / 1.0715 C15 / 1.0401	500 600	150 180	65-525	165-655	50-295
		C ≥ 0.15-0.45 %	S235JR (ST37-2) / 1.0037 Ck22 / 1.1151	400 600	120 180			
		C > 0.45 %	S355JO (St52-3) / 1.0553 C60 / 1.0601	600 900	180 270			
	Low-alloyed steel (alloy content ≤ 5%)	annealed	16MnCr5 / 1.7131 18CrNi8 / 1.5920	650 650	200 200	65-525	165-590	50-230
		heat-treatable	25CrMoV4 / 1.7218 42CrMo4V / 1.7225	900 1100	270 320			
	High-alloyed steel (alloy content > 5%)	annealed	X37CrMoV5-1 / 1.2343 X153CrMoV12 / 1.2379	750 850	220 250	80-295	130-460	-
		heat-treatable	55NiCrMoV7 / 1.2714	1200	350			
	Cast steel	un-alloyed, low-alloyed	GS52 / 1.0552	600	180	65-395	100-590	-
high-alloyed		GX40CrNiSi22-10 / 1.4826	750	220				
M	Stainless steel	martensitic, ferritic, tempered	X14CrMoS17 / 1.4104 X4CrNiMo16-5-1 / 1.4418	800 1000	240 300	65-230	100-295	-
		austenitic, Ni > 8%	X5CrNi18-10 / 1.4301 X2CrNiMo17-12-2 / 1.4404	650	200			
		austenitic, ferritic (Duplex)	X2CrNiMoCuN25-6-3 / 1.4507 X2CrNiMoN25-7-4 / 1.4410	850	250			
K	Grey cast iron	low tensile strength	EN-GJL-200 (GG20) / 0.6020		180	100-490	100-590	100-295
		high tensile strength	EN-GJL-400 (GG40) / 0.6040		260			
	Spheroidal graphite iron	low tensile strength	EN-GJS-400-15 (GGG40) / 0.7040		160	100-425	100-525	-
		high tensile strength	EN-GJS-700-2 (GGG70) / 0.7070		260			
	Malleable cast iron	low tensile strength	EN-GJMW-350-4 (GTW35) / 0.8035		125	100-425	100-525	-
		high tensile strength	EN-GJMB-550-4 (GTS55) / 0.8155		250			
N	Al-alloys	non-heat-treatable <12% Si	EN-AW-2017 (AlCuMg1) / 3.1325		60	100-1805	100-1805	100-820
		heat-treatable <12% Si	EN-AW-6082 (AlMgSi1) / 3.2315		100			
	Al-cast-alloys	non-heat-treatable <12% Si	AlSi9Cu3 / 3.2163		80	100-1805	100-1805	100-820
		heat-treatable <12% Si	AlSi10Mg / 3.2383		100			
	Copper alloys	brass, lead alloy	CuZn39Pb2 (MS58) / 2.0380	400	120	100-1310	100-1310	100-590
		bronze	CuSn6 / 2.1020	500	150			
S	Heat resistant alloys, super alloys	NiFe-base, annealed	NiCr15Fe (Alloy600) / 2.4816	700		-	50-230	-
		NiFe-base, hardened		950				
		NiCo-base, annealed	NiMo16Cr15W (Alloy C-276) / 2.4819	800				
		NiCo-base, cast		1100				
		NiCo-base, hardened	NiCr19NbMo (Alloy718) / 2.4668	1200				
	Titanium-alloys	annealed	Ti6Al4V / 3.7164	900		-	15-165	-
		hardened		1200				
H	Hardened steels	Heat-treatable steel		> 52 HRC	-	65-130	-	
		Heat-treatable/case hardened steel		> 59 HRC	-	30-100	-	
		Heat-treatable/case hardened steel		> 62 HRC	-	(CBN)	-	

The specified values must be adapted to the machine and machining conditions.



Troubleshooting

Subject		Solution											
		Feed	Feed at centre	Cutting speed	RH/LH edge orientation	Corner radius	Wiper	Width of groove	Tool clamping	Workpiece clamping	Tool overhang	Centre height of cutting edge	Coolant
Related to wear	Edge chipping	↓	↓			↑			🔍	🔍	🔍	🔍	
	Build up edge			↑									👍
	Flank wear	🔍	↓	↓		↑					🔍		👍
	Plastic deformation	↓	↑	↓		↑							👍
Related to the component	Vibrations	↑		↓		↓		↓	🔍	🔍	↓	🔍	
	Burrs		↓		👍	↓						🔍	👍
	Surface	↓	↓	↑		↑	👍	↑	🔍	🔍	↓	🔍	👍
	Long chips (no chip breakage)	↑		↑									👍
	(too) short chips, compressed chips	↓											

- ↓ decrease values (large impact)
- ↑ increase values (large impact)
- ↓ decrease values (low impact)
- ↑ increase values (low impact)
- 🔍 check
- 👍 apply



System 104/106

Positioning and clamping

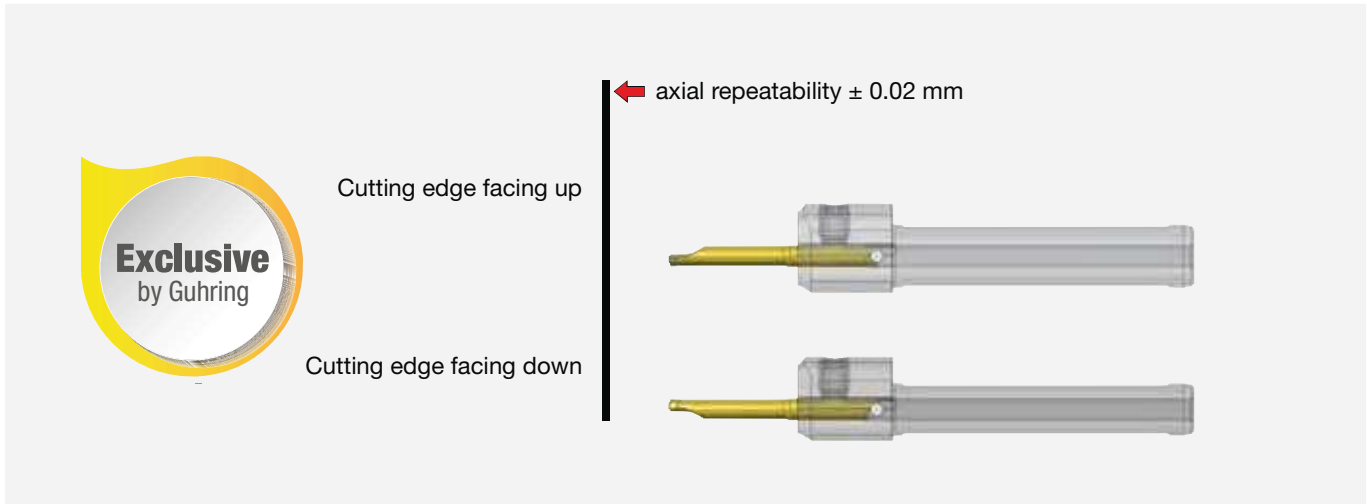

Guhring's system 104/106 is unique in terms of insert positioning and clamping: The position between cutting edge facing up and cutting edge facing down can be changed by keeping the same length position without loosening the holder.

Definition of the cutting edge position

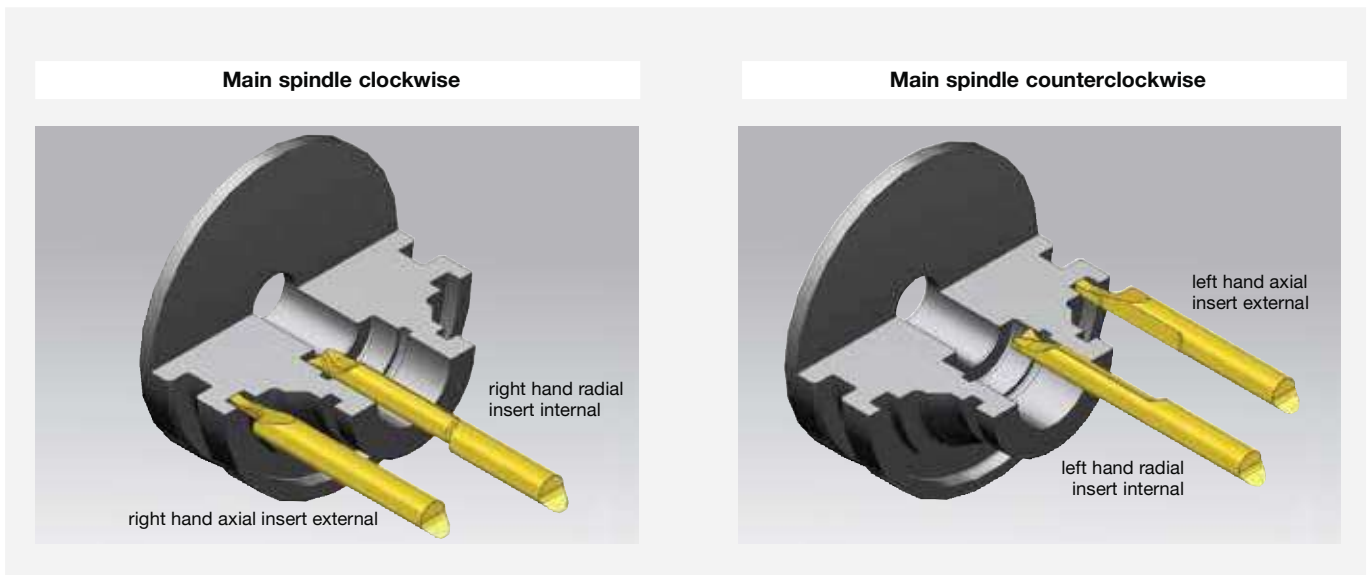



Internal threading System GG 104 and GG 106

Pitch/P		Recommended number of cuts with internal threading						
		Steel materials (tensile strength in N/mm ²)			Stainless steel	Cast iron	Heat-resistant alloys	Aluminium
mm	Gg/°	400-700	700-1150	> 1150				
0.3		3	4	5	5	3	5	3
0.5	48	5	6	8	8	5	8	5
0.8	32	7	8	9	9	7	9	7
1	24	8	9	10	10	8	10	8
1.25	20	10	11	12	12	10	12	10
1.5	16	12	13	15	15	12	15	12
1.75	14	14	15	18	18	14	18	14
2	12	16	17	20	20	16	20	16
3	8	22	24	30	30	22	30	22

Feed direction internal threading

Right-hand thread

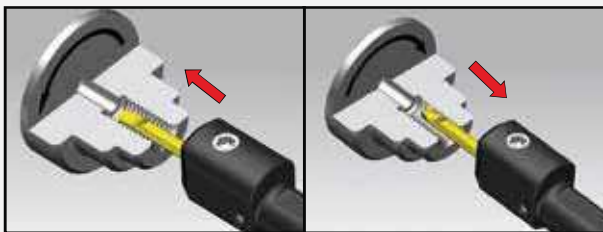

Insert: Right-hand design
Direction of rotation: Clockwise
M3 turning from outside in

Insert: Left-hand design
Direction of rotation: Counter-clockwise
M4 turning from inside out

Left-hand thread

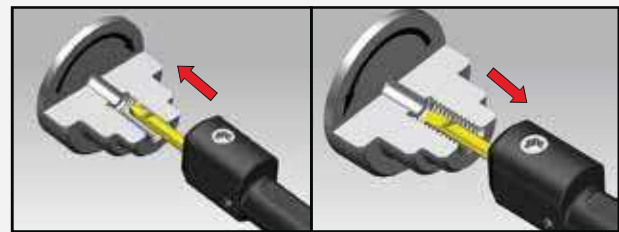

Insert: Left-hand design
Direction of rotation: Counterclockwise
M4 turning from outside in

Insert: Right-hand design
Direction of rotation: Clockwise
M3 turning from inside out

Feed process

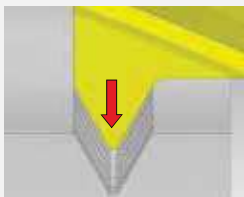

Radial feed

- Both cutting edges engaged at the same time
- High cutting pressure and thermal load
- Especially suitable for the machining of short-chipping materials
- For the production of threads with a small pitch and small thread depth as well as multiple start depths to prevent pitch errors



One-sided flank in-feed

- Only one cutting edge engaged
- Lower cutting pressure and thermal load
- Especially suitable for the machining of long-chipping materials
- Achieve a higher surface finish quality at the respective thread flank



Reciprocal flank in-feed

- Both cutting edges alternately engaged
- Lower cutting pressure and thermal load
- Especially suitable for the machining of long-chipping materials
- Achieve a higher surface finish quality at the flanks



Internal threading System GG 104 and GG 106

Pre-drill diameters for metric threads						
Standard pitch thread				Fine pitch thread		
Nominal Ø	Pitch mm	Pre-drill Ø* full profile mm	Pre-drill Ø partial profile mm	Nominal Ø	Pitch mm	Pre-drill Ø partial profile mm
M 2	0.40	1.50	1.60	M 2	0.20	1.80
M 2.5	0.45	1.85	2.05	M 2.5	0.35	2.15
M 3	0.50	2.40	2.50	M 3	0.35	2.65
M 4	0.7	3.10	3.30	M 3.5	0.35	3.15
M 4.5	0.75		3.75	M 4	0.50	3.50
M 5	0.80	4.00	4.20	M 4.5	0.50	4.00
M 6	1.00		5.00	M 5	0.50	4.50
M 8	1.25		6.80	M 5.5	0.50	5.00
M 10	1.5		8.5	M 6	0.75	5.25
M 12	1.75		10.25			

*max. allowance (ap) in core diameter = 0.2 mm

Application example

Application: Internal thread		Tool selection		Customer benefit
Component:	Threaded sleeve	System:	106	Guhring's cutting insert leads to considerably less manual re-working. The customer saves time and money.
Material:	TiAl 6 V 4	Holder:	GB106.0016.090.00.22.N.IK	
	3.7165	Insert:	GG106.TM08.125.22.68.R	
Machine:	Mazak Nexus 200			
Cooling:	12 bar			
Operat.step:	Threading			
vc:	25 m/min			
f:	Pitch			
ap:				
Groov. depth:				



SYSTEM 104

MICRO-PRECISION TOOLS



Round shank holder

from page 16



Square shank holder

from page 23



Modular holder

from page 25



Round shank holder
Broaching
page 56

Tool holder

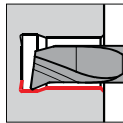

Boring out
and profiling, Type GT
from page 28

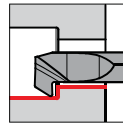

Back boring
and profiling, Type GT
from page 39

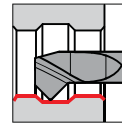

Boring out
and chamfering, Type GT
page 41

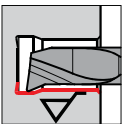

Boring out,
with Wiper, Type GJ
page 38

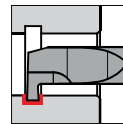

Internal grooving,
straight slots, Type GE
page 42

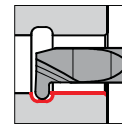

Internal grooving,
full radius slots, Type GE
page 44

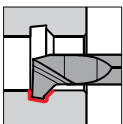

Internal pre-grooving
and chamfering, Type GV
page 45

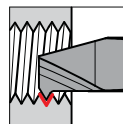

Internal threading,
Type GG
from page 51

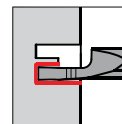

Axial grooving bores,
Type GA
from page 46

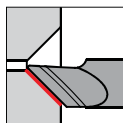

Axial chamfering
bores, Type GA
page 50

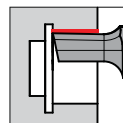

Broaching,
Type GN
from page 57

Cutting inserts from hole- \varnothing 0.7 mm