

HSK-C hydraulic chucks with increased clamping force

Product information

- balancing quality: G2.5 / 25,000 rev./min or U < 1 gmm
- axial length setting
- for tool shank tolerance h6
- HSK-C to ISO 12164-1/DIN 69893-1
- HSK-C32: with gripper groove, tapped hole for coolant supply set and bore for data chip

Scope of delivery

- incl. adjustment screw, Series no. 4900
- incl. hexagon chuck key, Series no. 4912

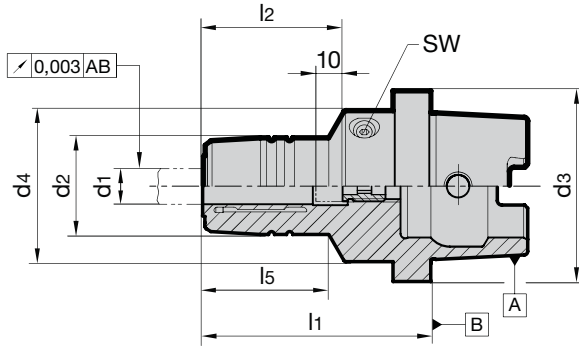

											Series no.	4267
HSK-C d ₃	for shank Ø d ₁ h ₆ mm	d ₂ mm	d ₄ mm	l ₁ mm	l ₂ mm	l ₅ mm	incl. setting screw 4900 ...	SW	kg	Code no.	EDP Number	
32	6	26	32	65	37.5	33	6.014	4	0.4	6.032	9042670060320	
32	8	28	32	67	37.5	34	8.014	4	0.4	8.032	9042670080320	
32	10	30	32	72.7	42.5	39	8.014	4	0.4	10.032	9042670100320	
32	12	31.5	32	76	46	45	8.014	4	0.4	12.032	9042670120320	
40	6	26	40	60	37	35	6.014	4	0.4	6.040	9042670060400	
40	8	28	40	60	37	36	8.014	4	0.4	8.040	9042670080400	
40	10	30	40	65	41	41	8.014	4	0.5	10.040	9042670100400	
40	12	32	40	70	46	47	8.014	4	0.6	12.040	9042670120400	
50	6	26	50	60	37	30	6.014	5	0.7	6.050	9042670060500	
50	8	28	50	60	37	30	8.014	5	0.7	8.050	9042670080500	
50	10	30	50	65	41	35	10.014	5	0.7	10.050	9042670100500	
50	12	32	50	75	46	44	12.014	5	0.8	12.050	9042670120500	
50	14	34	50	75	46	46	12.014	5	0.7	14.050	9042670140500	
50	16	38	50	80	49	51	16.014	5	0.8	16.050	9042670160500	
50	18	40	50	80	49	51	16.014	5	1.5	18.050	9042670180500	
50	20	42	50	80	51	52	20.114	5	1.2	20.050	9042670200500	
63	6	26	50	60	37	25	6.014	5	1.0	6.063	9042670060630	
63	8	28	50	60	37	26	8.014	5	1.0	8.063	9042670080630	
63	10	30	50	65	41	31	10.014	5	1.0	10.063	9042670100630	
63	12	32	50	75	46	41	12.014	5	1.1	12.063	9042670120630	
63	14	34	50	75	46	42	12.014	5	1.0	14.063	9042670140630	
63	16	38	50	80	49	48	16.014	5	1.1	16.063	9042670160630	
63	18	40	50	80	49	48	16.014	5	1.2	18.063	9042670180630	
63	20	42	50	80	51	49	20.114	5	1.2	20.063	9042670200630	
63	25	57	63	95	57	63	20.114	6	2.0	25.063	9042670250630	
63	32	62.5	75	100	61	60.3	20.114	6	2.0	32.063	9042670320630	

Product information

- for clamping smaller shank-Ø in hydraulic chucks
- clamping-Ø for tool shank tolerance h6
- concentricity $\leq 2 \mu\text{m}$
- with adjustable limit stop
- the application of reduction sleeves makes it possible to increase the permissible transferable torque by approx. 25% in comparison to direct clamping

Scope of delivery

- incl. stop element

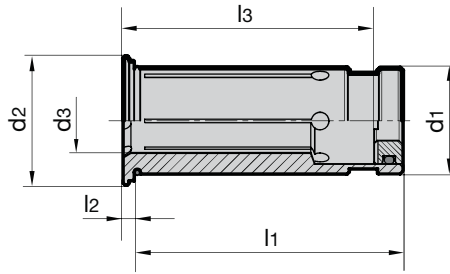

Series no. 4368

d ₁ inch/mm	for shank Ø d ₃ h ₆ inch/mm	d ₂ mm	l ₁ mm	l ₂ mm	l ₃ mm	Code no.	EDP Number
1/2	1/8	16.5	45	2	26.5	3.013	9043680030130
1/2	3/16	16.5	45	2	26.5	4.013	9043680040130
1/2	1/4	16.5	45	2	26.5	6.013	9043680060130
1/2	5/16	16.5	45	2	26.5	8.013	9043680080130
1/2	3/8	16.5	45	2	26.5	9.013	9043680090130
1/2	3/8	16.5	45	2	26.5	103.013	9043681030130
1/2	4	16.5	45	2	26.5	104.013	9043681040130
1/2	5	16.5	45	2	26.5	105.013	9043681050130
1/2	6	16.5	45	2	26.5	106.013	9043681060130
1/2	8	16.5	45	2	34.5	108.013	9043681080130
3/4	1/8	24	50.5	2	28.5	3.019	9043680030190
3/4	3/16	24	50.5	2	28.5	4.019	9043680040190
3/4	1/4	24	50.5	2	37.5	6.019	9043680060190
3/4	5/16	24	50.5	2	37.5	8.019	9043680080190
3/4	3/8	24	50.5	2	42.5	9.019	9043680090190
3/4	7/16	24	50.5	2	47.5	11.019	9043680110190
3/4	1/2	24	50.5	2	47.5	13.019	9043680130190
3/4	9/16	24	50.5	2	47.5	14.019	9043680140190
3/4	5/8	24	50.5	2	47.5	15.019	9043680150190
3/4	3	24	50.5	2	28.5	103.019	9043681030190
3/4	4	24	50.5	2	28.5	104.019	9043681040190
3/4	5	24	50.5	2	28.5	105.019	9043681050190
3/4	6	24	50.5	2	37.5	106.019	9043681060190
3/4	8	24	50.5	2	37.5	108.019	9043681080190
3/4	10	24	50.5	2	42.5	110.019	9043681100190
3/4	12	24	50.5	2	47.5	112.019	9043681120190
3/4	14	24	50.5	2	47.5	114.019	9043681140190
1 1/4	1/4	35.5	60.5	2	37.5	6.031	9043680060310
1 1/4	5/16	35.5	60.5	2	37.5	8.031	9043680080310
1 1/4	3/8	35.5	60.5	2	37.5	9.031	9043680090310
1 1/4	7/16	35.5	60.5	2	40.5	11.031	9043680110310
1 1/4	1/2	35.5	60.5	2	44.5	13.031	9043680130310
1 1/4	9/16	35.5	60.5	2	44.5	14.031	9043680140310
1 1/4	5/8	35.5	60.5	2	50.5	15.031	9043680150310
1 1/4	11/16	35.5	60.5	2	50.5	17.031	9043680170310
1 1/4	3/4	35.5	60.5	2	50.5	19.031	9043680190310
1 1/4	13/16	35.5	60.5	2	50.5	20.031	9043680200310
1 1/4	7/8	35.5	60.5	2	50.5	22.031	9043680220310
1 1/4	15/16	35.5	60.5	2	58.5	24.031	9043680240310
1 1/4	1	35.5	60.5	2	58.5	25.031	9043680250310
1 1/4	8	35.5	60.5	2	37.5	108.031	9043681080310
1 1/4	10	35.5	60.5	2	40.5	110.031	9043681100310
1 1/4	12	35.5	60.5	2	44.5	112.031	9043681120310
1 1/4	14	35.5	60.5	2	44.5	114.031	9043681140310
1 1/4	16	35.5	60.5	2	50.5	116.031	9043681160310
1 1/4	18	35.5	60.5	2	50.5	118.031	9043681180310

Reduction sleeves for hydraulic chucks, sealed

Series no. 4368

d ₁ inch/mm	for shank Ø d ₃ h ₆ inch/mm	d ₂ mm	l ₁ mm	l ₂ mm	l ₃ mm	Code no.	EDP Number
1 1/4	20	35.5	60.5	2	50.5	120.031	9043681200310
1 1/4	25	35.5	60.5	2	58.5	125.031	9043681250310
12	1/8	16.5	45	2	26.5	103.012	9043681030120
12	3/16	16.5	45	2	26.5	104.012	9043681040120
12	1/4	16.5	45	2	34.5	106.012	9043681060120
12	5/16	16.5	45	2	34.5	108.012	9043681080120
12	3/8	16.5	45	2	34.5	109.012	9043681090120
12	3	16.5	45	2	26.5	3.012	9043680030120
12	4	16.5	45	2	26.5	4.012	9043680040120
12	5	16.5	45	2	26.5	5.012	9043680050120
12	6	16.5	45	2	34.5	6.012	9043680060120
12	8	16.5	45	2	34.5	8.012	9043680080120
20	1/8	24	50.5	2	28.5	103.020	9043681030200
20	3/16	24	50.5	2	28.5	104.020	9043681040200
20	1/4	24	50.5	2	37.5	106.020	9043681060200
20	5/16	24	50.5	2	37.5	108.020	9043681080200
20	3/8	24	50.5	2	42.5	109.020	9043681090200
20	7/16	24	50.5	2	42.5	111.020	9043681110200
20	1/2	24	50.5	2	47.5	113.020	9043681130200
20	9/16	24	50.5	2	47.5	114.020	9043681140200
20	5/8	24	50.5	2	47.5	115.020	9043681150200
20	3	24	50.5	2	28.5	3.020	9043680030200
20	4	24	50.5	2	28.5	4.020	9043680040200
20	5	24	50.5	2	28.5	5.020	9043680050200
20	6	24	50.5	2	37.5	6.020	9043680060200
20	7	24	50.5	2	37.5	7.020	9043680070200
20	8	24	50.5	2	37.5	8.020	9043680080200
20	9	24	50.5	2	42.5	9.020	9043680090200
20	10	24	50.5	2	42.5	10.020	9043680100200
20	11	24	50.5	2	42.5	11.020	9043680110200
20	12	24	50.5	2	47.5	12.020	9043680120200
20	13	24	50.5	2	47.5	13.020	9043680130200
20	14	24	50.5	2	47.5	14.020	9043680140200
20	15	24	50.5	2	47.5	15.020	9043680150200
20	16	24	50.5	2	47.5	16.020	9043680160200
32	1/4	35.5	60.5	2	37.5	106.032	9043681060320
32	5/16	35.5	60.5	2	37.5	108.032	9043681080320
32	3/8	35.5	60.5	2	37.5	109.032	9043681090320
32	7/16	35.5	60.5	2	40.5	111.032	9043681110320
32	1/2	35.5	60.5	2	44.5	113.032	9043681130320
32	9/16	35.5	60.5	2	50.5	114.032	9043681140320
32	5/8	35.5	60.5	2	50.5	115.032	9043681150320
32	11/16	35.5	60.5	2	50.5	117.032	9043681170320
32	3/4	35.5	60.5	2	50.5	119.032	9043681190320
32	13/16	35.5	60.5	2	50.5	120.032	9043681200320
32	7/8	35.5	60.5	2	50.5	122.032	9043681220320
32	15/16	35.5	60.5	2	50.5	124.032	9043681240320
32	1	35.5	60.5	2	58.5	125.032	9043681250320
32	6	35.5	60.5	2	37.5	6.032	9043680060320
32	8	35.5	60.5	2	37.5	8.032	9043680080320
32	10	35.5	60.5	2	40.5	10.032	9043680100320
32	12	35.5	60.5	2	44.5	12.032	9043680120320
32	14	35.5	60.5	2	44.5	14.032	9043680140320
32	16	35.5	60.5	2	50.5	16.032	9043680160320
32	18	35.5	60.5	2	50.5	18.032	9043680180320
32	20	35.5	60.5	2	50.5	20.032	9043680200320
32	25	35.5	60.5	2	58.5	25.032	9043680250320

Product information

- for clamping smaller shank-Ø in hydraulic chucks
- clamping-Ø for tool shank tolerance h6
- with coolant slots for peripheral cooling, therefore process and tool life improvement
- concentricity $\leq 2 \mu\text{m}$
- with adjustable limit stop
- the application of reduction sleeves makes it possible to increase the permissible transferable torque by approx. 25% in comparison to direct clamping

Scope of delivery

- incl. stop element

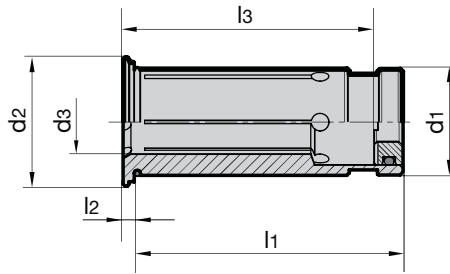

Series no. 4369

d_1 inch/mm	for shank Ø d_3 h6 inch/mm	d_2 mm	l_1 mm	l_2 mm	l_3 mm	Code no.	EDP Number
1/2	1/8	16.5	45	2	26.5	3.013	9043690030130
1/2	3/16	16.5	45	2	26.5	4.013	9043690040130
1/2	1/4	16.5	45	2	26.5	6.013	9043690060130
1/2	5/16	16.5	45	2	26.5	8.013	9043690080130
1/2	3/8	16.5	45	2	26.5	9.013	9043690090130
1/2	5	16.5	45	2	26.5	105.013	9043691050130
1/2	6	16.5	45	2	26.5	106.013	9043691060130
3/4	1/8	24	50.5	2	28.5	3.019	9043690030190
3/4	3/16	24	50.5	2	28.5	4.019	9043690040190
3/4	1/4	24	50.5	2	37.5	6.019	9043690060190
3/4	5/16	24	50.5	2	37.5	8.019	9043690080190
3/4	3/8	24	50.5	2	42.5	9.019	9043690090190
3/4	7/16	24	50.5	2	42.5	11.019	9043690110190
3/4	1/2	24	50.5	2	47.5	13.019	9043690130190
3/4	9/16	24	50.5	2	47.5	14.019	9043690140190
3/4	5/8	24	50.5	2	47.5	15.019	9043690150190
3/4	3	24	50.5	2	28.5	103.019	9043691030190
3/4	4	24	50.5	2	28.5	104.019	9043691040190
3/4	6	24	50.5	2	37.5	106.019	9043691060190
3/4	8	24	50.5	2	37.5	108.019	9043691080190
3/4	10	24	50.5	2	42.5	110.019	9043691100190
3/4	12	24	50.5	2	47.5	112.019	9043691120190
3/4	14	24	50.5	2	47.5	114.019	9043691140190
1 1/4	1/4	35.5	60.5	2	37.5	6.031	9043690060310
1 1/4	5/16	35.5	60.5	2	37.5	8.031	9043690080310
1 1/4	3/8	35.5	60.5	2	37.5	9.031	9043690090310
1 1/4	1/2	35.5	60.5	2	44.5	13.031	9043690130310
1 1/4	9/16	35.5	60.5	2	44.5	14.031	9043690140310
1 1/4	5/8	35.5	60.5	2	50.5	15.031	9043690150310
1 1/4	11/16	35.5	60.5	2	50.5	17.031	9043690170310
1 1/4	3/4	35.5	60.5	2	50.5	19.031	9043690190310
1 1/4	7/8	35.5	60.5	2	50.5	22.031	9043690220310
1 1/4	1	35.5	60.5	2	58.5	25.031	9043690250310
1 1/4	20	35.5	60.5	2	50.5	120.031	9043691200310
1 1/4	25	35.5	60.5	2	58.5	125.031	9043691250310
12	1/8	16.5	45	2	26.5	103.012	9043691030120
12	3/16	16.5	45	2	26.5	104.012	9043691040120
12	1/4	16.5	45	2	34.5	106.012	9043691060120
12	5/16	16.5	45	2	34.5	108.012	9043691080120
12	3/8	16.5	45	2	34.5	109.012	9043691090120
12	3	16.5	45	2	26.5	3.012	9043690030120
12	4	16.5	45	2	26.5	4.012	9043690040120
12	5	16.5	45	2	26.5	5.012	9043690050120
12	6	16.5	45	2	34.5	6.012	9043690060120
12	8	16.5	45	2	34.5	8.012	9043690080120

Series no. 4369

d ₁ inch/mm	for shank Ø d ₃ h ₆ inch/mm	d ₂ mm	l ₁ mm	l ₂ mm	l ₃ mm	Code no.	EDP Number
20	1/8	24	50.5	2	28.5	103.020	9043691030200
20	3/16	24	50.5	2	28.5	104.020	9043691040200
20	1/4	24	50.5	2	37.5	106.020	9043691060200
20	5/16	24	50.5	2	37.5	108.020	9043691080200
20	3/8	24	50.5	2	42.5	109.020	9043691090200
20	7/16	24	50.5	2	42.5	111.020	9043691110200
20	1/2	24	50.5	2	47.5	113.020	9043691130200
20	9/16	24	50.5	2	47.5	114.020	9043691140200
20	5/8	24	50.5	2	47.5	115.020	9043691150200
20	3	24	50.5	2	28.5	3.020	9043690030200
20	4	24	50.5	2	28.5	4.020	9043690040200
20	5	24	50.5	2	28.5	5.020	9043690050200
20	6	24	50.5	2	37.5	6.020	9043690060200
20	7	24	50.5	2	37.5	7.020	9043690070200
20	8	24	50.5	2	37.5	8.020	9043690080200
20	9	24	50.5	2	42.5	9.020	9043690090200
20	10	24	50.5	2	42.5	10.020	9043690100200
20	11	24	50.5	2	42.5	11.020	9043690110200
20	12	24	50.5	2	47.5	12.020	9043690120200
20	13	24	50.5	2	47.5	13.020	9043690130200
20	14	24	50.5	2	47.5	14.020	9043690140200
20	15	24	50.5	2	47.5	15.020	9043690150200
20	16	24	50.5	2	47.5	16.020	9043690160200
32	1/2	35.5	60.5	2	44.5	113.032	9043691130320
32	5/8	35.5	60.5	2	50.5	115.032	9043691150320
32	3/4	35.5	60.5	2	50.5	119.032	9043691190320
32	7/8	35.5	60.5	2	50.5	122.032	9043691220320
32	1	35.5	60.5	2	58.5	125.032	9043691250320
32	6	35.5	60.5	2	37.5	6.032	9043690060320
32	8	35.5	60.5	2	37.5	8.032	9043690080320
32	10	35.5	60.5	2	40.5	10.032	9043690100320
32	12	35.5	60.5	2	44.5	12.032	9043690120320
32	14	35.5	60.5	2	44.5	14.032	9043690140320
32	16	35.5	60.5	2	50.5	16.032	9043690160320
32	18	35.5	60.5	2	50.5	18.032	9043690180320
32	20	35.5	60.5	2	50.5	20.032	9043690200320
32	25	35.5	60.5	2	58.5	25.032	9043690250320

Extraction key for reduction bushes

Product information

- for Series no. 4368 and 4369
- for the simple removal of reduction bushes



	Series no.
	4099
for reduction bushes d ₁	EDP Number
12 to 32	9040990010000

Senso 3000

Product information

- accurate, quick and simple measuring of the clamping force of hydraulic chucks
- mobility allows measuring within machines and fixtures
- determines clamping force via a pressure sensitive plug gauge
- display of absolute measuring value or percentage clamping force in relation to reference value

Scope of delivery

- incl. type CR 2430 battery
- incl. sturdy case
- Inch dimensions upon request



	Series no.
	4038
clamping diameter mm	EDP Number
6.0	9040380060000
8.0	9040380080000
10.0	9040380100000
12.0	9040380120000
14.0	9040380140000
16.0	9040380160000
18.0	9040380180000
20.0	9040380200000
25.0	9040380250000
32.0	9040380320000
kg	
1.1	
1.1	
1.3	
1.3	
1.3	
1.3	
1.5	
1.5	
2.0	
2.5	

Operating instructions for Hydraulic chucks

TECHNICAL INFORMATION AND ADVANTAGES

Clamping standard tool shanks to DIN 6535 in hydraulic chucks

Direct clamping
of tool preferred
run-out ≤ 0.003 mm

Form HA $\varnothing 6 \dots 20$ mm



Form HA $\varnothing 25 \dots 32$ mm

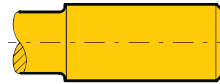

Form HB $\varnothing 6 \dots 20$ mm



Clamping of tool shank
only with reduction bushes
run-out ≤ 0.005 mm

Form HB $\varnothing 25 \dots 32$ mm



Form HE $\varnothing 6 \dots 20$ mm

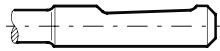

Form HE $\varnothing 25 \dots 32$ mm



General notes:

Our hydraulic chucks must not be operated with motor-driven tools (impulse screwdrivers or similar). The hexagonal key should not exceed the key size over its entire length, this largely prevents excessive torque being transferred. We recommend the hexagon clamping key, Series no. 4912. A tightening moment of 10 Nm must not be exceeded.

Gühring Hydraulic chucks with increased clamping force

Hydraulic chucks are suitable for clamping rotary symmetrical tools or workpieces. Straight shank tools without drive flats may be clamped up to $\varnothing 32$ mm, but also shanks according to DIN 6535 form HA and HB up to $\varnothing 20$ mm without reduction sleeves. The given values in the table below are not to be exceeded. If the inserted length is less than the given minimum insertion depth or other tool shanks than specified above are applied, lower accuracy and breakage may occur!

Above all it is the high revolutions with High-Speed-Cutting operations that puts special demands on the tool holder. The clamping of the tool in a hydraulic chuck is, therefore, especially significant. Gühring has developed a hydraulic chuck that offers reliable and powerful clamping with higher torque figures, guaranteeing excellent tool clamping in the tool holder.

Combined with precise concentricity (max. 3 μm deviation from concentricity), a very fast and simple tool change as well as the vibration cushioning effect of the pressure chamber, the new hydraulic chuck can tackle the most demanding of machining tasks. The result is optimal tool life and excellent surface qualities or dimensional accuracy of the workpiece respectively.

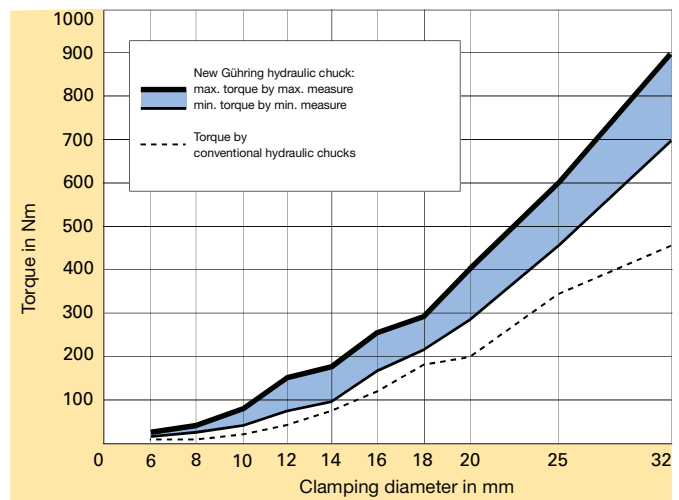

Considerably higher:
The clamping force of Gühring's new HSK-A hydraulic chuck in comparison to conventional chucks.

Hydraulic chucks

TECHNICAL INFORMATION AND ADVANTAGES

Modern machining processes place heavy demands on tool holding. Hydraulic chucks provide excellent clamping characteristics combined with precise concentricity. Furthermore, they enable a simple and fast tool change, with the assistance of a special extraction key. Turning the pressure screw generates sufficient pressure in the pressure chamber resulting in an elastic deformation of the clamping bush, providing powerful tool clamping and precise concentricity. A safe and powerful fit is guaranteed. If reduction sleeves are applied that are able to hold varying tool diameters, the tool application may be extended without problem. If such bushes are not applied, it is essential to observe the minimum clamping length!

A summary of the advantages:

- precise tool clamping with a maximum 3 µm deviation from concentricity
- transmission of high torque through (excellent clamping) optimised bush clamping system
- high speed compatibility (no centrifugal forces from clamping segments)
- precise concentricity, therefore excellent surface qualities and dimensional accuracy of the workpiece
- rapid tool change thanks to simple operation of the clamping screw
- optimal tool life
- hydraulic cushioning has vibration absorbing effect

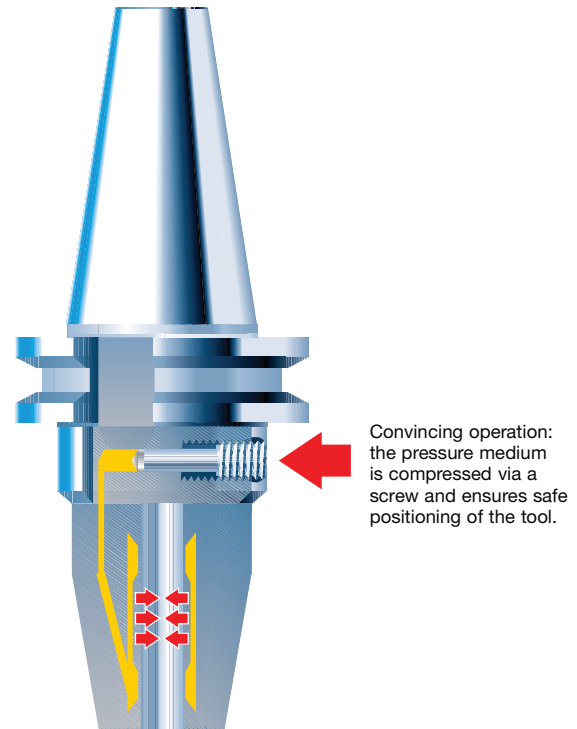
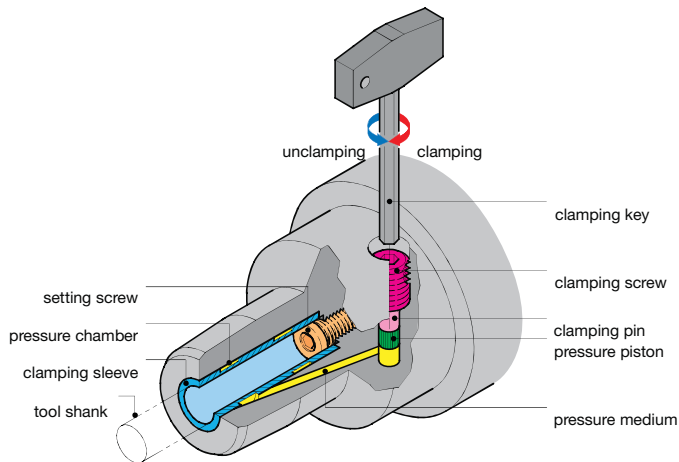

for shank-Ø in mm	max. r.p.m. in 1/min	max. transferable torque in Nm	min. insertion depth in mm	max. adjustment l ₃ mm	max. rad. force F on chuck with 50 mm from the nose in N	operating temperature in °C	max. coolant pressure in bar
3 h6	50 000	2.5	27	7	25	20 - 50	80
4 h6	50 000	6	27	7	40	20 - 50	80
5 h6	50 000	10	27	7	65	20 - 50	80
6 h6	50 000	16	27	10	225	20 - 50	80
8 h6	50 000	26	27	10	370	20 - 50	80
10 h6	50 000	50	31	10	540	20 - 50	80
12 h6	50 000	82	36	10	650	20 - 50	80
14 h6	50 000	125	36	10	900	20 - 50	80
16 h6	50 000	190	39	10	1410	20 - 50	80
18 h6	50 000	275	39	10	1580	20 - 50	80
20 h6	50 000	310	41	10	1860	20 - 50	80
25 h6	25 000	520	47	10	4400	20 - 50	80
32 h6	25 000	770	51	10	6500	20 - 50	80